

GENERAL CATALOG

① Electronics in the Control Cabinet

② Interfaces

③ Connection Technology

④ I/O Systems

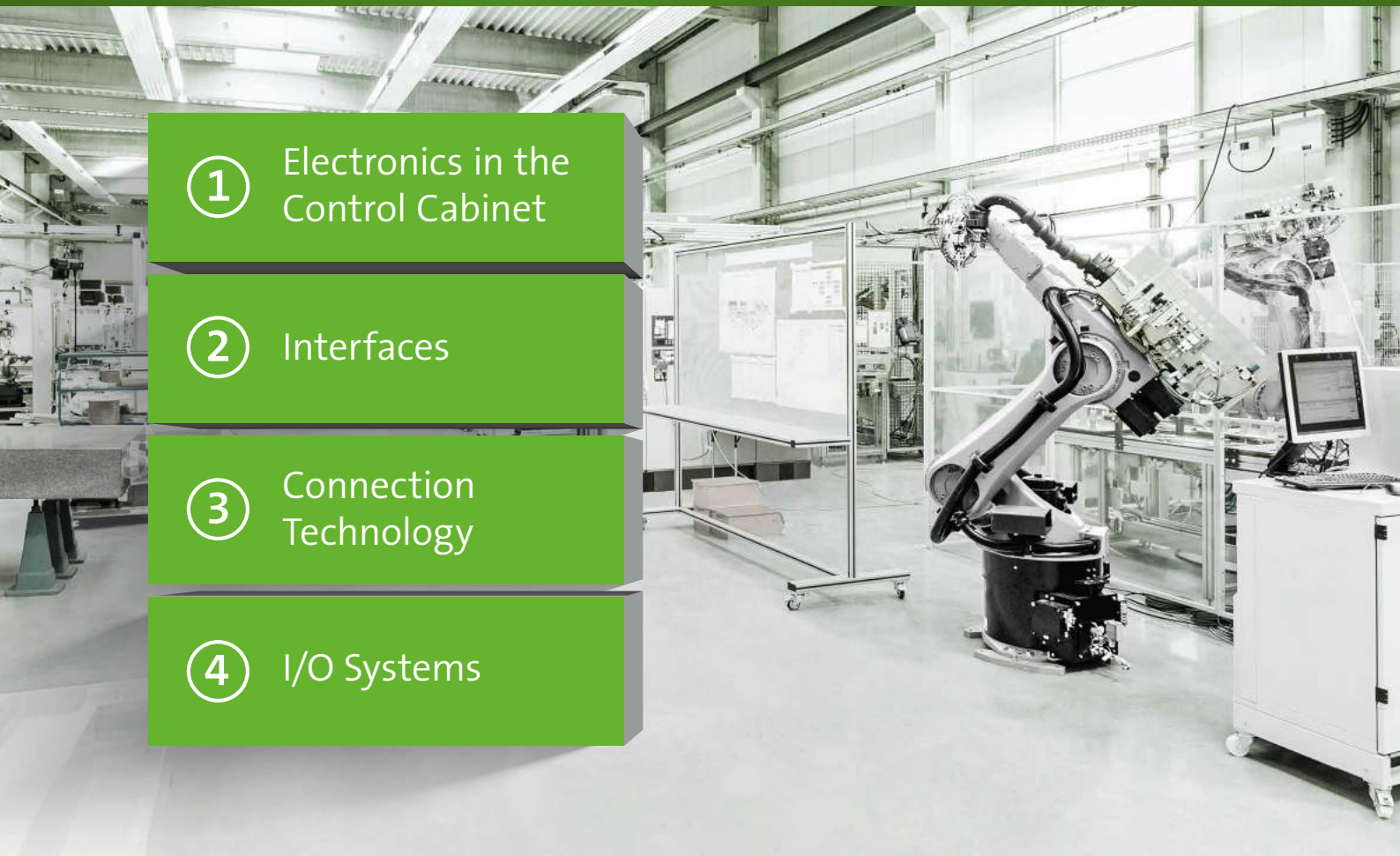

GENERAL CATALOG

Note:

With this new main catalog, all information contained in previous brochures/catalogs expires. All drawings, diagrams, indications of weight, dimensions, ratings or other details printed in this catalog are only binding when specifically agreed upon.

Murrelektronik reserves the right to changes and modifications. The customer is responsible for using the components and units that they ordered in the way they are designed.

The information in this brochure has been compiled with the utmost care. Liability for the correctness, completeness and topicality of the information is restricted to gross negligence.

1st edition: January 2019

Part No. 9800012

Murrelektronik GmbH,
Falkenstr. 3, D-71570 Oppenweiler

www.murrelektronik.com

With compliments:

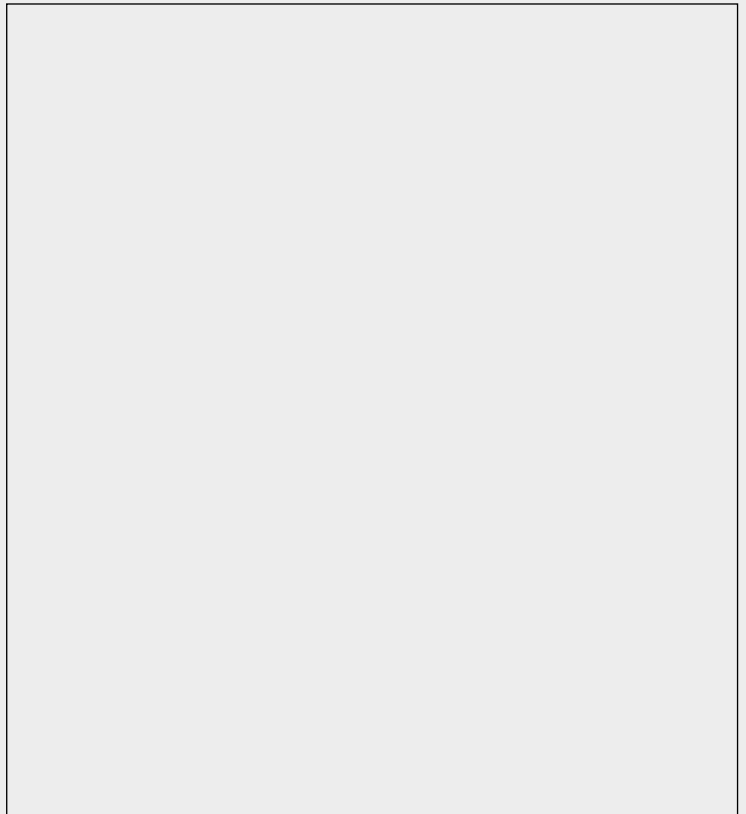

MURRELEKTRONIK GOES EVEN GREENER!



Being sustainable and respecting nature are part of our core values here. That's why we print our catalogs on uncoated paper which is produced without any solvents, chlorine and is environmentally friendly. Our supply chain is also an environmentally friendly production process.

We, here at Murrelektronik, are proud to say we act responsibly and protect the environment.



1

ELECTRONICS IN THE CONTROL CABINET

- 1.1 Transformers / Rectified Power Supplies
- 1.2 Power Supply Units
- 1.3 UPS-Systems / Buffer- / Redundancy Modules
- 1.4 Intelligent Power Distribution
- 1.5 Converters / Rectifiers
- 1.6 Control Cabinet Power Outlets
- 1.7 EMC Filters
- 1.8 EMC Suppressors
- 1.9 Relays / Safety Relays
- 1.10 Optocouplers / Semiconductors
- 1.11 Switches
- 1.12 Active Interface Technology
- 1.13 Passive Interface Technology
- 1.14 Eurocard Holders / Control Modules



2

INTERFACES

- 2.1 Front Panel Interfaces
- 2.2 Control Cabinet Interfaces / Cable Entry Systems
- 2.3 Hybrid Fieldbus Coupling
- 2.4 Lighting Elements
- 2.5 Control Devices
- 2.6 Modular Connection Systems (Modlink Vario)
- 2.7 Heavy Duty Connectors (Modlink Heavy)



3**CONNECTION TECHNOLOGY**

- 3.1 M8 Round Plug Connectors
- 3.2 M12 Round Plug Connectors
- 3.3 T-couplers M8, M12, 7/8"
- 3.4 Flange Connectors
- 3.5 MQ12 Round Plug Connectors
- 3.6 Fieldbus Connectors
- 3.7 Plug Connectors for Food & Beverage
- 3.8 Mobile Applications
- 3.9 M23 Round Plug Connectors
- 3.10 Round Plug Connectors Power
- 3.11 TPE Series – The North American standard
- 3.12 Valve Connectors
- 3.13 Technical Appendix Cables

**4****I/O SYSTEMS**

- 4.1 Cube67
- 4.2 Cube20
- 4.3 Cube20S
- 4.4 MVK Metal
- 4.5 SOLID67
- 4.6 Impact67
- 4.7 IO-Link Devices
- 4.8 MASI Control Cabinet
- 4.9 MASI Field Installation
- 4.10 MASI Installation Technology
- 4.11 M8 Distribution Systems
- 4.12 M12 Distribution Systems (Metal)
- 4.13 M12 Distribution Systems (Plastic)





**26 BRANCH OFFICES
AND 5 PRODUCTION PLANTS**

Oppenweiler
Production Fieldbus Systems

Stollberg, Germany
Production of Connectors

Stod, Czech Republic
Production of Interface,
Switch Mode Power Supplies,
Transformers

Shanghai, China
Production for the
Asian markets



**STAY CONNECTED – REPRESENTED
ON ALL CONTINENTS WORLDWIDE**

The company was founded in 1975 by Franz Hafner

Over 2,700 employees, including 250 sales reps and customer service center technicians

Top student training is very important for Murrelektronik. Each year we offer apprenticeships in technical and commercial areas, as well as in logistics.



MURRELEKTRONIK FIGURES & FACTS

Atlanta, USA
Production of Connectors



MURRELEKTRONIK IS YOUR PARTNER...

- Over 65,000 products available to order conveniently in our online shop
- Subdivided into four product fields:
 - **Electronics in the Control Cabinet**
 - **Interfaces**
 - **Connection Technology**
 - **I/O Systems**
- For industries and market segments as for example:
 - **Machine Tools**
 - **Machine Building and Plant Engineering**
 - **Assembly and Handling Technology**
 - **Food and Beverage**
 - **Automotive Industry**
 - **Warehousing and Logistics**
 - **Robotic**
- Founded in Oppenweiler, Germany, in 1975
- Family-owned company



**CUSTOMER
LOYALTY WITH
INDIVIDUAL
AND
COMPETENT
ON-SITE HELP**

MURRELEKTRONIK OFFER VALUABLE BENEFITS

- Over 250 sales reps
- On-site support
- 5 international warehouses
- 1 million products in stock

- Murrelektronik Express Service

mex
More service

MURRELEKTRONIK YOUR BENEFITS



International approvals for
flexible applications worldwide

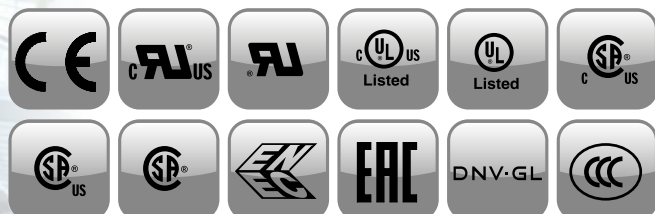

MURRELEKTRONIK QUALITY



MURRELEKTRONIK STANDS FOR QUALITY

- In-house test center and EMC lab for tested and accredited products
- Individual and competent on-site advice and support
- No use of hazardous materials
- Complies with RoHS requirements
- First-class design and production quality
- Systematic and sustainable quality management according to DIN EN ISO 9001

Tested and accredited:
In-house test center
and EMC laboratory



Endurance tests
under extreme
conditions



Product testing begins
at the beginning of the
project





connec+ivity®
by Murrelektronik

**THE BACK BONE OF YOUR MACHINE
AND SYSTEM INSTALLATIONS**

ASSESSING STATUS

- On-site analysis
- Exchanging the basic documentation
- Discussing the current status

SELECTING THE DESIGN

- Concept overview
- Analyzing advantages and disadvantages
- Bills of materials

CREATING A CONCEPT

- Customer-specific requirements
- Industry-specific requirements
- Several concept options

PROJECT SUPPORT

- E-plan and CAD data
- Electronic catalog data (BMEcat)
- Setup support

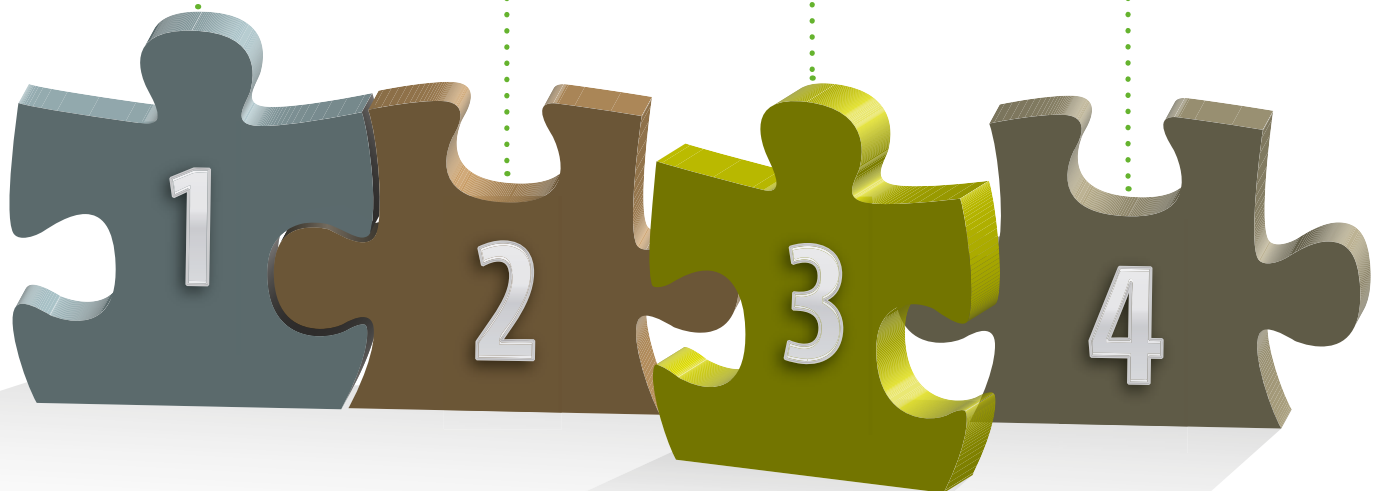

CONNECTIVITY BY MURRELEKTRONIK

CONNECTIVITY MEANS INDIVIDUAL SOLUTIONS

- Best advice increases your competitive advantage
- Decrease your budget significantly
- We optimize your machine and system installation
- Highly skilled, specially trained staff
- Individual system solutions
- Consistent from a single source

SYSTEM ADVICE WITH CONNECTIVITY CITY

Go from the industry overview
to your application ...



... to the appropriate products.



MURRELEKTRONIK REPRESENTED ON ALL CONTINENTS WORLDWIDE



GERMANY

Murrelektronik GmbH
Falkenstraße 3
D-71570 Oppenweiler
Phone +49 7191 47-0
Fax +49 7191 47-491000
info@murrelektronik.de
www.murrelektronik.de



ARGENTINA

NAKASE SRL
ventas@nakase.com
www.nakase.com.ar



AUSTRALIA

Sick Pty. Ltd.
sales@sick.com.au
www.sick.com.au



AUSTRIA

Murrelektronik GmbH Austria
info@murrelektronik.at
www.murrelektronik.at



BELGIUM

Murrelektronik B.V.B.A.
info@murrelektronik.be
www.murrelektronik.be



BRAZIL

Murrelektronik do Brasil
Indústria e Comércio Ltda.
info@murrelektronik.com.br
www.murrelektronik.com.br



BOSNIA HERZEGOVINA

Murrelektronik GmbH Austria
info@murrelektronik.at
www.murrelektronik.at



BULGARIA

Murrelektronik GmbH Austria
info@murrelektronik.at
www.murrelektronik.at



CANADA

Murrelektronik Canada
info@murrelektronik.ca
www.murrelektronik.ca



CHILE

Electrónica Rhomberg Ltda.
info@rhomberg.cl
www.rhomberg.cl



CHINA

Murrelektronik Components Co. Ltd.
info@murrelektronik.com.cn
www.murrelektronik.com.cn



CROATIA

Murrelektronik GmbH Austria
info@murrelektronik.at
www.murrelektronik.at



CZECH REPUBLIC

Murrelektronik CZ spol. s.r.o.
info@murrelektronik.cz
www.murrelektronik.cz



DENMARK

Murrelektronik ApS
info@murrelektronik.dk
www.murrelektronik.dk



EGYPT

DANA Import & Export
usama@dana-egy.com
www.murrelektronik.com/en



FINLAND

Murrelektronik Power Oy
info@murrelektronik.fi
www.murrelektronik.fi



FRANCE

Murrelektronik S.A.S.
info@murrelektronik.fr
www.murrelektronik.fr



GREAT BRITAIN

Murrelektronik Ltd.
info@murrelektronik.co.uk
www.murrelektronik.uk



HUNGARY

Murrelektronik Kft.
info@murrelektronik.hu
www.murrelektronik.hu



ISLAND

Reykjafell hf
reykjafell@reykjafell.is
www.reykjafell.is



INDIA

Murrelektronik Pvt. Ltd.
info@murrelektronik.in
www.murrelektronik.in



INDONESIA

Murr Asia-Pacific Pte. Ltd.
sales@murrelektronik.sg
www.murrelektronik.sg



IRAN

Shahin Power and Industry Co.
info@shahin-co.ir
www.shahin-co.ir



ISRAEL

O.M.S.T Marketing & Import Ltd.
miki@omst.co.il
www.omst.co.il



ISRAEL

Ancitech Ltd.
info@ancitech.com
www.ancitech.com



ITALY

Murrelektronik S.r.l.
info@murrelektronik.it
www.murrelektronik.it



JAPAN

K.MECS Co., Ltd.
info@murrelektronik.jp
www.murrelektronik.jp



KENYA

Profa-Tech Ltd.
info@profa-tech.com
www.profa-tech.com



LEBANON

Praucs
fouad.riachy@praucs.com
www.praucs.com



MALAYSIA

Murr Asia-Pacific Pte. Ltd.
sales@murrelektronik.sg
www.murrelektronik.sg



MALTA

AIM Enterprises Ltd.
info@aim.com.mt
www.aim.com.mt

MURRELEKTRONIK REPRESENTED WORLDWIDE

**MEXICO**

Murrelektronik Inc.
mluque@murrinc.com
www.murrinc.com

**NETHERLANDS**

Murrelektronik B.V.
sales@murrelektronik.nl
www.murrelektronik.nl

**NEW ZEALAND**

Sick Pty. Ltd.
sales@sick.co.nz
www.sick.co.nz

**NORWAY**

Murrelektronik A.S.
post@murrelektronik.no
www.murrelektronik.no

**PAKISTAN**

Overseas Enterprises
info@oe.com.pk
rehan_k@oe.com.pk
www.oe.com.pk

**PERU**

Techpro SAC
techpro.peru@techprocorp.net
www.techprocorp.net

**POLAND**

Murrelektronik Sp. z o.o.
info@murrelektronik.pl
www.murrelektronik.pl

**PORTUGAL**

F.Fonseca S.A.
ffonseca@ffonseca.com
www.ffonseca.com

**ROMANIA**

Murrelektronik GmbH Austria
info@murrelektronik.at
www.murrelektronik.at

**RUSSIA**

Murrelektronik GmbH
info@murrelektronik.com
www.murrelektronik.ru

**SERBIA**

Murrelektronik GmbH Austria
info@murrelektronik.at
www.murrelektronik.at

**SINGAPORE**

Murr Asia-Pacific Pte. Ltd.
sales@murrelektronik.sg
www.murrelektronik.sg

**SLOVAKIA**

Murrelektronik Slovakia s.r.o.
info@murrelektronik.sk
www.murrelektronik.sk

**SLOVENIA**

Murrelektronik GmbH Austria
info@murrelektronik.at
www.murrelektronik.at

**SPAIN**

Murrelektronik Spain S.L.U.
ventas@murrelektronik.es
www.murrelektronik.es

**SOUTH AFRICA**

Rubicon Electrical
and Automation
eldred@rubiconsa.com
www.rubiconsa.com

**SOUTH KOREA**

Murrelektronik Korea Ltd.
sales@murrelektronik.kr
www.murrelektronik.kr

**SRI LANKA**

Sim Lanka (Pvt) Ltd.
info@simlanka.com
www.simlanka.com

**SWEDEN**

Murrelektronik AB
info@murrelektronik.se
www.murrelektronik.se

**SWITZERLAND**

Murrelektronik AG
info@murrelektronik.ch
www.murrelektronik.ch

**TAIWAN**

Lintronix Co. Ltd.
info@lintronix.com.tw
www.lintronix.com.tw

**THAILAND**

Maxtech Control Co., Ltd.
info@maxtechcontrol.co.th
www.maxtechcontrol.co.th

**TURKEY**

Murr Elektronik San. ve Tic. Ltd. Sti
info@murrelektronik.com.tr
www.murrelektronik.com.tr

**UNITED ARAB EMIRATES**

King Power Electrical Accessories Trading
kpower@eim.ae
www.kingpowerelectrical.ae

**USA**

Murrelektronik Inc.
2info@murrinc.com
www.murrinc.com

**VIETNAM**

OMINA Industrial Automation J.S.C
inquiry@omina.com.vn
www.omina.com.vn



1

ELECTRONICS IN THE CONTROL CABINET

1

ELECTRONICS IN THE CONTROL CABINET

Transformers / Rectified Power Supplies		1.1
Power Supply Units		1.2
UPS-Systems / Buffer- / Redundancy Modules		1.3
Intelligent Power Distribution		1.4
Converters / Rectifiers		1.5
Control Cabinet Power Outlets	<i>An overview of this product range can be found in our online shop</i>	1.6
EMC Filters		1.7
EMC Suppressors		1.8
Relays / Safety Relays		1.9
Optocouplers / Semiconductors		1.10
Switches		1.11
Active Interface Technology	<i>An overview of this product range can be found in our online shop</i>	1.12
Passive Interface Technology	<i>An overview of this product range can be found in our online shop</i>	1.13
Eurocard Holders / Control Modules	<i>An overview of this product range can be found in our online shop</i>	1.14

TRANSFORMERS / RECTIFIED POWER SUPPLIES

- Approvals for the global market
- Flexible and versatile
- Customized solutions

MTS, MST, MET OR MTL – THE RIGHT TRANSFORMER FOR EVERY APPLICATION

Different situations require different voltages. Transformers have to be just as flexible as the application. Murrelektronik's range provides you with the flexibility you need!

No matter if it's an isolation transformer, control transformer, or safety transformer – we have the right solution for any application. Murrelektronik's transformers are reliable, safe and their approvals and voltage ranges make them ideal for worldwide use.

BASIC FUNCTIONS

Rectified power supplies galvanically separate input and output. They convert mains voltage into Protected Extra Low Voltage. The electronic unit rectifies and smooths the voltage.

Rectified power supplies are designed for a frequency of 50/60 Hz. Their slow reaction prevents voltage spikes from being passed from the mains side to the output, which would interfere with peripheral devices.

They have fixing brackets with keyholes that ensure easy wall mounting. Models for DIN-rail mounting are available for applications up to 5 A.

Transformers



MTS – Isolation class T 40/B

- Nominal power rating: 40...250 VA
- Input voltage: 230, 400 V AC or multi voltage (± 15 V AC)
- Output voltage: 24 V AC or 230 V AC
- Ambient temperature: 40 °C

Page 1.1.1



MST – Isolation class T 40/B

- Nominal power rating: 320...1000 VA
- Input voltage: 230, 400 V AC or multi voltage
- Output voltage: 24 V AC or 230 V AC
- Ambient temperature: 40 °C

Page 1.1.4



MTL – Isolation class T 60/B

- Nominal power rating: 25...2500 VA
- Input voltage: 230/400 V AC ± 15 V AC
- Output voltage: 2 x 24 V AC or 2 x 115 V AC
- Ambient temperature: 60 °C

Page 1.1.7

Single-phase, single/two-phase, smoothed (Rectified Power Supplies)



MEN

- Input voltage: 115/230 V AC and 230/400 V AC
±15 V AC reconnectable
- Output voltage: 24 V DC SELV
- Output current: 1.0/2.5/5/7.5/10/15/20 A

Page 1.1.8



MTPS

- Input voltage: 230/400 V AC
±15 V AC reconnectable
- Output voltage: 24 V DC SELV
- Output current: 0.5/1/2/4/6/10 A

Page 1.1.12

Three-phase, smoothed (Rectified Power Supplies)



MPL

- Input voltage: 3 × 400 V AC ±5% reconnectable
3 × 208...520 V AC
- Output voltage: 24 V DC SELV
- Output current: 5...60 A

Page 1.1.13

TRANSFORMERS / RECTIFIED POWER SUPPLIES

1-/2-phase

– INPUT: 230/400 V AC

– Isolation class T 40/B

Approvals: 

MTS

OUTPUT: 230 V AC
Screw terminals



MTS

OUTPUT: 230 V AC
Spring clamp terminals

MTS

OUTPUT: 24 V AC
Screw terminals

MTS

OUTPUT: 24 V AC
Spring clamp terminals

Circuit diagram

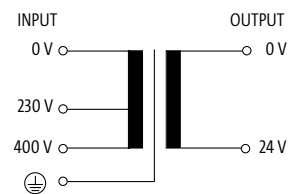
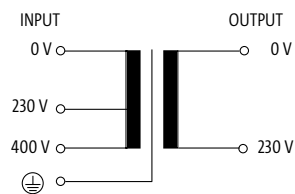

Order Data	HxWxD/kg	Art-No.	HxWxD/kg	Art-No.	HxWxD/kg	Art-No.	HxWxD/kg	Art-No.
40 VA	79x78x93/0.8	86346	79x78x93/0.8	6686346	79x78x93/0.8	86340	79x78x93/0.8	6686340
63 VA	79x78x93/1.2	86347	79x78x93/1.2	6686347	79x78x93/1.2	86341	79x78x93/1.2	6686341
100 VA	86x84x98/2.0 – GL	86348	86x84x98/2.0	6686348	86x84x98/2.0 – GL	86342	86x84x98/2.0	6686342
160 VA	101x96x106/2.7 – GL	86349	101x96x106/2.7	6686349	101x96x106/2.7 – GL	86343	101x96x106/2.7	6686343
250 VA	102x96x108/3.5 – GL	86351	102x96x108/3.5	6686351	102x96x108/3.5 – GL	86345	102x96x108/3.5	6686345

Input	
Input voltage	230/400 V AC
Frequency	50...60 Hz
Output	
Output voltage	230 V AC 24 V AC (SELV)
Output rating	40 VA
General data	
Test isolation voltage	4 kV (prim./sec.)
Standards	EN 61558-1, EN 61558-2-4, EN 62041 category 0 EN 61558-1, EN 61558-2-6, EN 62041 category 0
Mounting method	Long-hole mounting or DIN-rail mountable TH35 (EN 60715)
Temperature range	-20...+40 °C (storage temperature -40...+80 °C)
Dimension drawing	

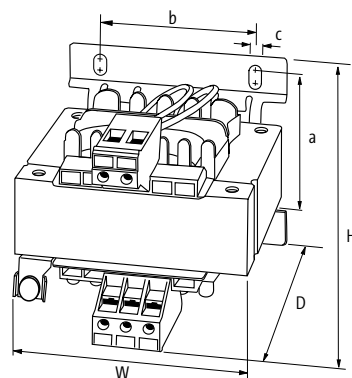

Notes	
	GL-Approval from 100 VA and with screw terminals.

TRANSFORMERS / RECTIFIED POWER SUPPLIES

1-/2-phase

– INPUT: 230/400 ±15 V AC

– Isolation class T 40/B

Approvals: 

MTS+

OUTPUT: 230 V AC
Screw terminals



MTS+

OUTPUT: 230 V AC
Spring clamp terminals



MTS+

OUTPUT: 24 V AC
Screw terminals



MTS+

OUTPUT: 24 V AC
Spring clamp terminals



Circuit diagram

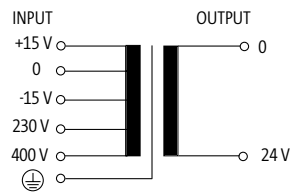
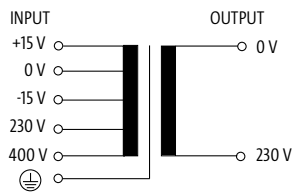

Order Data	HxWxD/kg	Art-No.	HxWxD/kg	Art-No.	HxWxD/kg	Art-No.	HxWxD/kg	Art-No.
40 VA	79×78×93/0.8	86366	79×78×93/0.8	6686366	79×78×93/0.8	86360	79×78×93/0.8	6686360
63 VA	79×78×93/1.2	86367	79×78×93/1.2	6686367	79×78×93/1.2	86361	79×78×93/1.2	6686361
100 VA	86×84×98/2.0 – GL	86368	86×84×98/2.0	6686368	86×84×98/2.0 – GL	86362	86×84×98/2.0	6686362
160 VA	101×96×106/2.7 – GL	86369	101×96×106/2.7	6686369	101×96×106/2.7 – GL	86363	101×96×106/2.7	6686363
250 VA	102×96×108/3.5 – GL	86371	102×96×108/3.5	6686371	102×96×108/3.5 – GL	86365	102×96×108/3.5	6686365

Input	
Input voltage	230/400 ±15 V AC
Frequency	50..60 Hz
Output	
Output voltage	230 V AC 24 V AC (SELV)
Output rating	40 VA
General data	
Standards	EN 61558-1, EN 61558-2-4, EN 62041 category 0 EN 61558-1, EN 61558-2-6, EN 62041 category 0
Test isolation voltage	4 kV (prim./sec.)
Mounting method	Long-hole mounting or DIN-rail mountable TH35 (EN 60715)
Temperature range	-20...+40 °C (storage temperature -40...+80 °C)

Dimension drawing

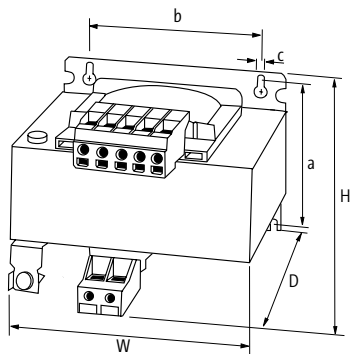

Notes

GL-Approval from 100 VA and with screw terminals.

TRANSFORMERS / RECTIFIED POWER SUPPLIES

1-2-phase

– INPUT: 208...550 V AC

– Isolation class T 40/B

Approvals: 

MTS Multi

OUTPUT: 1 × 230, 1 × 115, 2 × 115 V AC

Screw terminals



Circuit diagram

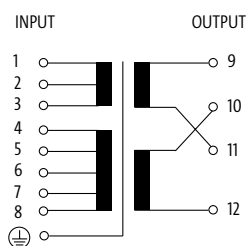

Order Data	H×W×D/kg	Art-No.
25 VA	90×78×102/0.7	86140
40 VA	88×78×93/1.1	86141
63 VA	97×78×93/1.4	86142
100 VA	105×84×98/2.0 – GL	86143
160 VA	101×96×106/2.7 – GL	86144

Input	
Input voltage	208, 230, 380, 400, 420, 440, 460, 480, 500, 525, 550 V AC
Frequency	50...60 Hz
Output	
Output voltage	1 × 230, 1 × 115, 2 × 115 V AC
Output rating	25 VA
General data	
Standards	EN 61558-1, EN 61558-2-4, EN 62041 category 0
Test isolation voltage	4 kV (prim./sec.)
Mounting method	Long-hole mounting or DIN-rail mountable TH35 (EN 60715)
Temperature range	-20...+40 °C (storage temperature -20...+80 °C)
Dimension drawing	

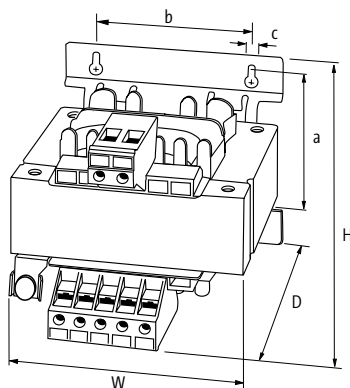

Notes
GL-Approval from 100 VA and with screw terminals.

TRANSFORMERS / RECTIFIED POWER SUPPLIES

1-/2-phase
 – INPUT: 230/400 V AC
 – Isolation class T 40/B

Approvals: 

MST

OUTPUT: 230 V AC
 Screw terminals



MST

OUTPUT: 230 V AC
 Spring clamp terminals

MST

OUTPUT: 24 V AC
 Screw terminals

MST

OUTPUT: 24 V AC
 Spring clamp terminals

Circuit diagram

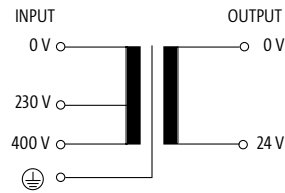
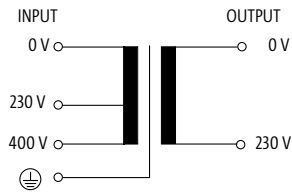

Order Data	HxWxD/kg	Art-No.	HxWxD/kg	Art-No.	HxWxD/kg	Art-No.	HxWxD/kg	Art-No.
320 VA	92x120x122/4.2 – GL	86306	92x120x122/4.2	6686306	92x120x122/4.2 – GL	86326	92x120x122/4.2	6686326
400 VA	104x120x123/5.2 – GL	86307	104x120x123/5.2	6686307	104x120x123/5.2 – GL	86327	104x120x123/5.2	6686327
500 VA	108x135x134/6.5 – GL	86308	108x135x134/6.5	6686308	108x135x134/6.5 – GL	86328		
630 VA	113x150x145/7.7 – GL	86309	113x150x145/7.7	6686309	113x150x145/7.7 – GL	86329		
800 VA	129x150x145/10.1 – GL	86310	129x150x145/10.1	6686310	136x150x149/10.1 – GL	86330		
1 000 VA	128x174x160/12.3 – GL	86311	128x174x160/12.3	6686311	133x174x165/12.3 – GL	86331		

Input

Input voltage 230/400 V AC
 Frequency 50...60 Hz

Output

Output voltage 230 V AC 24 V AC (SELV)
 Output rating 320 VA

General data

Standards EN 61558-1, EN 61558-2-4, EN 62041 category 0 EN 61558-1, EN 61558-2-6, EN 62041 category 0
 Test isolation voltage 4 kV (prim./sec.)
 Mounting method Key-hole mounting
 Temperature range -20...+40 °C (storage temperature -40...+80 °C)

Dimension drawing

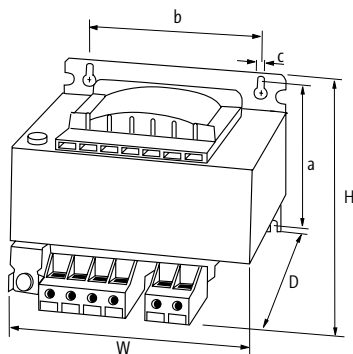

Notes

TRANSFORMERS / RECTIFIED POWER SUPPLIES

1-/2-phase

– INPUT: 230/400 ±15 V AC

– Isolation class T 40/B

Approvals:  

MST+

OUTPUT: 24 V AC, 48 V AC
Screw terminals



MST+

OUTPUT: 115 V AC, 230 V AC
Screw terminals

Circuit diagram

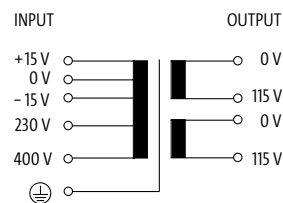
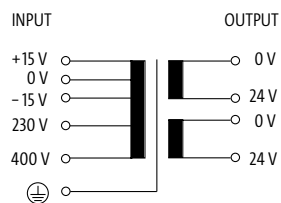

Order Data	H×W×D/kg	Art-No.	H×W×D/kg	Art-No.
630 VA	121×150×165/8.0	86463	113×150×146/8.2	86483
1 000 VA	156×150×197/13.5	86464	156×150×146/13.5	86484
1 600 VA	168×174×222/19.5	86465	168×174×163/19.5	86485
2 500 VA	182×192×242/27.0	86466	182×192×196/27.0	86486

Input	
Input voltage	230/400 ±15 V AC
Frequency	50...60 Hz
Output	
Output voltage	1 × 24, 1 × 48, 2 × 24 V AC 1 × 230, 1 × 115, 2 × 115 V AC
Output rating	630 VA
General data	
Standards	EN 61558-1, EN 61558-2-4, EN 62041 category 0
Test isolation voltage	5.8 kV (prim./sec.)
Mounting method	Key-hole mounting
Temperature range	-20...+40 °C, no condensation
Dimension drawing	

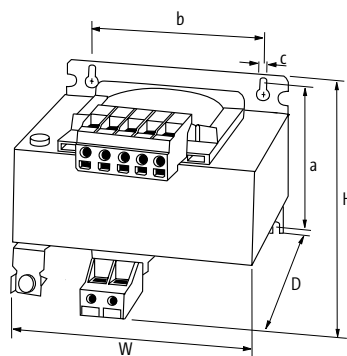

Notes

TRANSFORMERS / RECTIFIED POWER SUPPLIES

1-/2-phase

– INPUT: 208...550 V AC

– Isolation class T 40/B

Approvals:  

MST Multi

OUTPUT: 1 × 230, 1 × 115, 2 × 115 V AC

Screw terminals



Circuit diagram

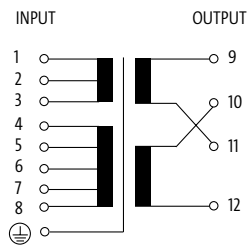

Order Data	H×W×D/kg	Art-No.
250 VA	104×120×122/4.0	86145
320 VA	115×135×132/5.8	86146
400 VA	115×135×132/6.2	86147
500 VA	138×135×135/5.8	86148
800 VA	156×150×150/7	86150
1 000 VA	128×174×160/12.3	86151
1 600 VA	168×174×163/7	86152
2 000 VA	185×192×185/10	86153
2 500 VA	200×195×217/10	86154
3 000 VA	250×197×193/29.5	86155
5 000 VA	248×197×250/9	86157

Input

Input voltage 208, 230, 380, 400, 420, 440, 460, 480, 500, 525, 550 V AC
 Frequency 50...60 Hz

Output

Output voltage 1 × 230, 1 × 115, 2 × 115 V AC
 Output rating 250 VA

General data

Standards EN 61558-1, EN 61558-2-4, EN 62041 category 0
 Test isolation voltage 4 kV (prim./sec.)
 Mounting method Key-hole mounting
 Temperature range -20...+40 °C (storage temperature -20...+80 °C)

Dimension drawing

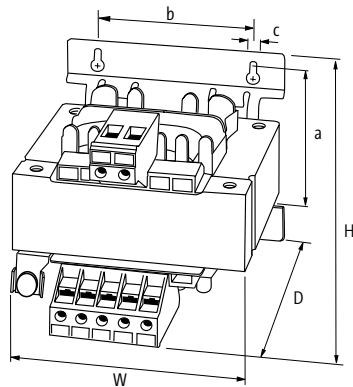

Notes

TRANSFORMERS / RECTIFIED POWER SUPPLIES

1-/2-phase

– INPUT: 230/400 ±15 V AC

– Isolation class T 60/B

Approvals:  

MTL

OUTPUT: 24 V AC, 48 V AC
Screw terminals



MTL

OUTPUT: 115 V AC, 230 V AC
Screw terminals

Circuit diagram

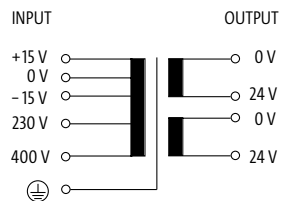

Order Data	H×W×D/kg	Art-No.	H×W×D/kg	Art-No.
25 VA	108×87×98/1.1	86450	108×87×98/1.1	86470
40 VA	108×87×104/1.4	86451	108×87×104/1.4	86471
63 VA	108×87×116/2.0	86452	108×87×116/2.0	86472
100 VA	108×87×139/2.9	86453	108×87×139/2.9	86473
160 VA	153×123×128/4.4	86454	153×123×128/4.4	86474
250 VA	153×123×142/5.7	86455	153×123×142/5.7	86475
320 VA	153×123×160/7.2	86456	153×123×160/7.2	86476

Technical Data

LED display LED (green) for input voltage

Input

Input voltage 230/400 ±15 V AC

Frequency 50...60 Hz

Output

Output voltage 1 × 24, 1 × 48, 2 × 24 V AC

1 × 230, 1 × 115, 2 × 115 V AC

Output rating 25 VA

General data

Test isolation voltage 5.1 kV (prim./sec.) 4 kV (prim./sec.)

Standards EN 61558-2-4, EN 61558-2-6, EN 62041 category 0 EN 61558-1, EN 61558-2-4, EN 62041 category 0

Mounting method DIN-rail mountable TH35-15 (EN 60715) or for key-hole mounting

Temperature range -20...+60 °C, no condensation

Dimension drawing

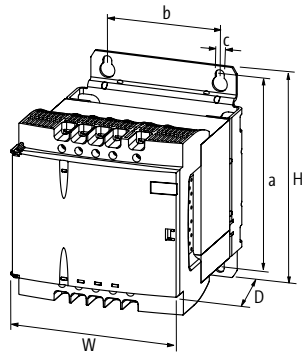

Notes

TRANSFORMERS / RECTIFIED POWER SUPPLIES

Single-phase

– OUTPUT: 24 V DC (SELV)

Approvals: 

MEN

INPUT: 115/230 V AC



MEN

INPUT: 115/230 V AC
with MES DIN-rail adapter

Circuit diagram

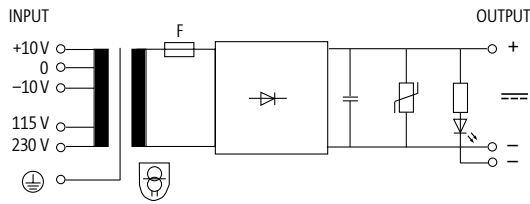

Order Data	HxWxD/kg	Art-No.	HxWxD/kg	Art-No.
24 V DC/1 A	64x78x120/1.3	85360	64x78x120/1.3	8985360
24 V DC/2.5 A	83x84x124/2.1	85361	83x84x124/2.1	8985361
24 V DC/5 A	95x96x136/3.0	85362	95x96x136/3.0	8985362
24 V DC/7.5 A	103x105x151/5.6	85363		

Input

Input voltage	115/230 V AC ± 10 V AC
Frequency	50...60 Hz

Output

Output voltage	24 V DC (SELV)
Ripple	max. 5 %rms
Output filter	LED, VDR and smoothing capacitor

General data

Standards	EN 61558-2-6, EN 62041 category I, EN 55011 B, EN 61000-3-2	
Mounting method	Key-hole mounting	DIN-rail mountable TH35-15 (EN 60715) or for key-hole mounting
Temperature range	-20...+60 °C, no condensation	

Dimension drawing

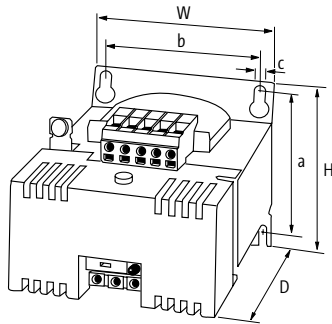

Notes

TRANSFORMERS / RECTIFIED POWER SUPPLIES

Single-phase

– OUTPUT: 24 V DC (SELV)

MEN

INPUT: 115/230 V AC



Approvals:

Circuit diagram

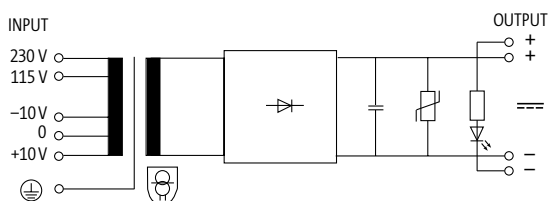

Order Data	H×W×D/kg	Art-No.
24 V DC/10 A	113×120×160/6.0	85364
24 V DC/15 A	139×135×182/8.2	85355
24 V DC/20 A	127×174×214/12.8	85356
Input		
Input voltage	115/230 V AC ±10 V AC	
Frequency	50...60 Hz	
Output		
Output voltage	24 V DC (SELV)	
Ripple	max. 5 %rms	
Output filter	LED, VDR and smoothing capacitor	
General data		
Standards	EN 61558-2-6, EN 62041 category I, EN 55011 B, EN 61000-3-2	
Mounting method	Key-hole mounting	
Temperature range	-20...+60 °C, no condensation	
Dimension drawing		

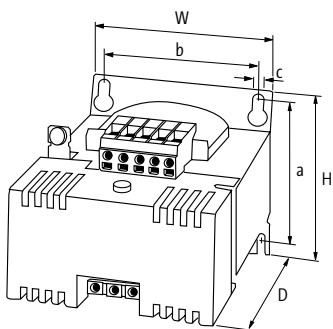

Notes

TRANSFORMERS / RECTIFIED POWER SUPPLIES

1-/2-phase

– OUTPUT: 24 V DC (SELV)

Approvals: 

MEN

INPUT: 230/400 V AC



MEN

INPUT: 230/400 V AC
with MES DIN-rail adapter

Circuit diagram

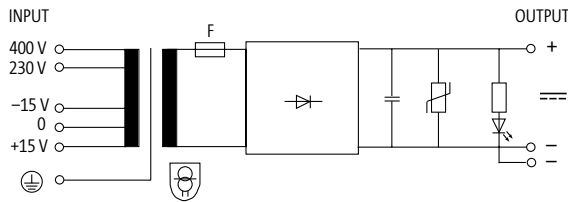

Order Data	HxWxD/kg	Art-No.	HxWxD/kg	Art-No.
24 V DC/1 A	64x78x120/1.3	85349	64x78x120/1.3	8985349
24 V DC/2.5 A	83x84x124/2.1	85350	83x84x124/2.1	8985350
24 V DC/5 A	95x96x136/3.0	85351	95x96x136/3.0	8985351
24 V DC/7.5 A	103x105x151/5.6	85357		

Input

Input voltage	230/400 ±15 V AC
Frequency	50...60 Hz

Output

Output voltage	24 V DC (SELV)
Ripple	max. 5 %rms
Output filter	LED, VDR and smoothing capacitor

General data

Standards	EN 61558-2-6, EN 62041 category I, EN 55011 B, EN 61000-3-2	
Mounting method	Key-hole mounting	DIN-rail mountable TH35-15 (EN 60715) or for key-hole mounting
Temperature range	-20...+60 °C, no condensation	

Dimension drawing

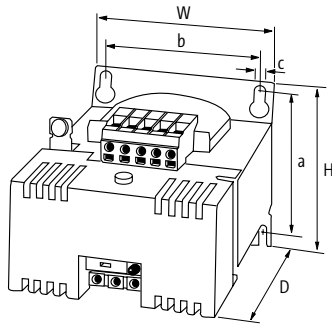

Notes

TRANSFORMERS / RECTIFIED POWER SUPPLIES

1-/2-phase

– OUTPUT: 24 V DC (SELV)

MEN

INPUT: 230/400 V AC



Approvals:

Circuit diagram

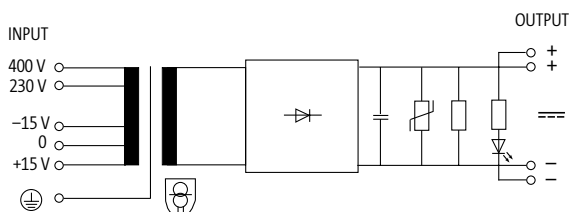

Order Data	H×W×D/kg	Art-No.
24 V DC/10 A	113×120×160/6.0	85352
24 V DC/15 A	139×135×182/8.2	85353
24 V DC/20 A	127×174×214/12.8	85354
Input		
Input voltage	230/400 ±15 V AC	
Frequency	50...60 Hz	
Output		
Output voltage	24 V DC (SELV)	
Ripple	max. 5 %rms	
Output filter	LED, VDR and smoothing capacitor	
General data		
Standards	EN 61558-2-6, EN 62041 category I, EN 55011 B, EN 61000-3-2	
Mounting method	Key-hole mounting	
Temperature range	-20...+60 °C, no condensation	
Dimension drawing		

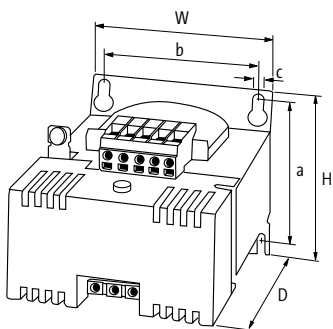

Notes

TRANSFORMERS / RECTIFIED POWER SUPPLIES

1-/2-phase

– OUTPUT: 24 V DC (SELV)

Approvals:  

MTPS

INPUT: 230/400 V AC



Circuit diagram

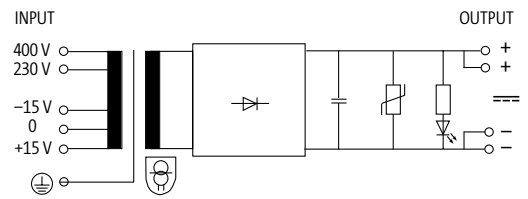
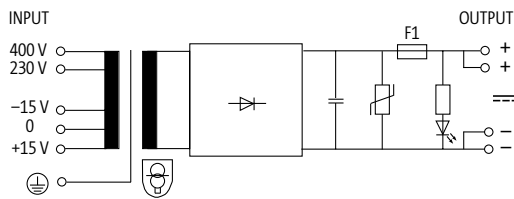

Order Data	HxWxD/kg	Art-No.	HxWxD/kg	Art-No.
24 V DC/0.5 A	108x87x124/1.3	85400		
24 V DC/1 A	108x87x124/1.3	85401		
24 V DC/2 A	108x87x142/2.0	85402		
24 V DC/4 A	108x87x165/2.9	85403		
24 V DC/6 A	153x123x153/4.9	85404		
24 V DC/10 A			153x123x185/7.7	85405
Input				
Input voltage	230/400 ±15 V AC			
Frequency	50...60 Hz			
LED display	LED (green) for input voltage			
Output				
Output voltage	24 V DC (SELV)			
Ripple	max. 5 %rms			
Output filter	LED, VDR and smoothing capacitor			
General data				
Standards	EN 61558-2-6, EN 62041 category I, EN 55011 B, EN 61000-3-2			
Temperature range	-20...+60 °C, no condensation			
Mounting method	DIN-rail mountable TH35-15 (EN 60715) or for key-hole mounting		Key-hole mounting	

Dimension drawing

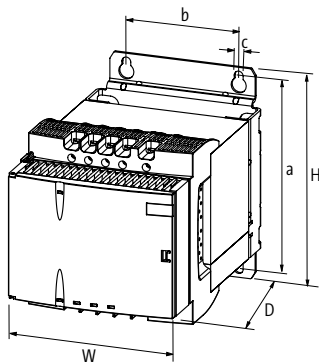

Notes

3-phase

– OUTPUT: 24 V DC (SELV)

Approvals: UL Listed

MPL

INPUT: 3 × 400 V AC, ±5% reconnectable



MPL Multi

INPUT: 3 × 208...520 V AC



Circuit diagram

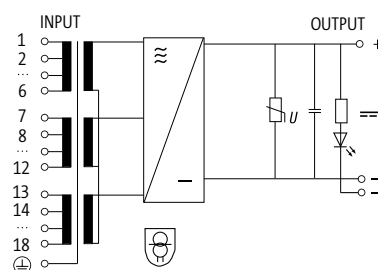
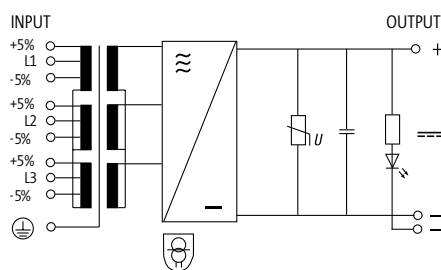

Order Data	HxWxD/kg	Art-No.	HxWxD/kg	Art-No.
24 V DC/5 A	125x73x153/2.9 – cURus	85921		
24 V DC/7.5 A	185x78x188/4.4 – cURus	85923		
24 V DC/10 A	185x78x188/4.5 – cURus	85925	185x93x188/6.6	85953
24 V DC/15 A	220x82x208/8.2 – cURus	85927	220x82x208/7.5	85954
24 V DC/20 A	220x103x213/10.5 – cURus	85929		
24 V DC/25 A	220x103x213/11.0 – cURus	85931	220x103x213/11.1 – cURus	85955
24 V DC/30 A	240x107x250/13.5 – cURus	85933		
24 V DC/40 A	280x124x313/17.8 – cURus	85935	280x124x313/17.9 – cURus	85956
24 V DC/50 A	280x134x313/20.9 – cURus	85937	280x134x313/20.9 – cURus	85957
24 V DC/60 A	280x154x313/26.1 – cURus	85939		

Input		
Input voltage	3 × 400 V AC ±5%	3 × 208...520 V AC
Frequency	50...60 Hz	

Output	
Output voltage	24 V DC (SELV)
Ripple	max. 2%rms
Output filter	LED, VDR and smoothing capacitor

General data	
Standards	EN 61558-2-6, EN 62041 category I, EN 55011 B, EN 61000-3-2
Mounting method	Key-hole mounting
Temperature range	-20...+55 °C, for any mounting position at vertical wall, no condensation

Dimension drawing

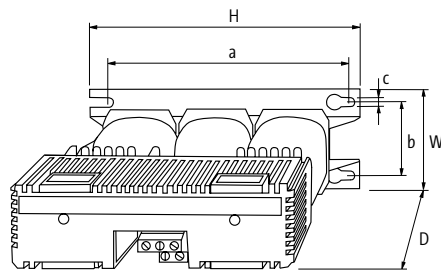

Notes



SWITCHING POWER SUPPLIES EMPARRO® – SIMPLY THE BEST

- Efficiency up to 96%
- 150% Power Boost for 4 seconds

EMPARRO® – THE SWITCHING POWER SUPPLY WITH MAXIMUM EFFICIENCY

- Efficiency up to 96%
- 150% Power Boost for four seconds
- Metal housing with optimum EMC characteristics
- Derating only at +60 °C
- Reduced width
- Long bridging time in case of a power failure
- More than 30 variants – the solution for many applications

Competitive comparison of Emparro®

The comparison based on the same input current shows: Emparro (on the left) releases



significantly less heat than conventional switching power supplies. The devices remain cooler

and protect the neighboring components. This results in a longer service life.

Switching power supplies



Emparro®

- Single-phase, two-phase, three-phase
- Spring clamp terminal
- AS-Interface

Page 1.2.1



Emparro® HD

- Single-phase
- Robust design

Page 1.2.4



Emparro®67

- Single-phase
- IP67
- IO-Link
- Preventive diagnostics



Page 1.2.8



Evolution/Evolution+

- Two-phase, three-phase
- Extended temperature range from -25...+70 °C
- Approvals for worldwide use

Page 1.2.10



ECO-Rail-2

- Single-phase
- Useful and flexible

Page 1.2.16



PICCO

- Single-phase
- 16 variants
- 12 V or 24 V outputs
- 10 W, 30 W, 60 W or 100 W

Page 1.2.18

POWER SUPPLY UNITS

Single-phase

– Short-circuit and overload protected

– Alarm contact

Approvals:

Emparro®

OUTPUT: 24...28 V DC
Current: 5 A



Emparro®

OUTPUT: 24...28 V DC
Current: 10 A



Emparro®

OUTPUT: 24...28 V DC
Current: 20 A



Order Data	Art-No.	Art-No.	Art-No.
24 V DC/5 A (for DIN-Rail)	85440		
24 V DC/5 A (for screwing)	85702		
24 V DC/10 A (for DIN-Rail)		85441	
24 V DC/10 A (for screwing)		85703	
24 V DC/20 A (for DIN-Rail)			85442
24 V DC/20 A (for screwing)			85704
Input			
Input voltage	85...265 V AC/90...250 V DC		90...265 V AC/90...250 V DC
Input current	1.3 A (100 V AC); 0.61 A (240 V AC)	2.6 A (100 V AC); 1.1 A (240 V AC)	5.2 A (100 V AC); 2.2 A (240 V AC)
Inrush current after 1 ms	max. 5.5 A (230 V AC)	max. 13 A	max. 23 A (230 V AC)
Power factor	0.87 (230 V AC)	0.95 (230 V AC)	0.96 (230 V AC)
Frequency	50...60 Hz		
Input fuse (internal)	6.3 A (T)		10 A (T)
Output			
Output voltage	24 V DC (SELV), ±1%; 24...28 V adjustable		
Power Boost	I _{out} N × 150% (min. 4 s)		
Output current	5 A	10 A	20 A
Mains failure bridging time	min. 30 ms (100 V AC); 5 A (24 V DC)	min. 30 ms (100 V AC); 10 A (24 V DC)	min. 30 ms (100 V AC); 20 A (24 V DC)
Ripple	max. 50 mVrms		
Spikes	max. 200 mV p-p		
Unit protection	Short-circuit and overload protected		
LED display	LED (green): OK; LED (red): overload, overheating or short-circuit		
Parallel usage/serial usage	max. 5 units/max. 2 units		
General data			
Standards	EN 60950-1, EN 61204-3, EN 55011 B, EN 61000-3-2, SEMI F47		
Relative humidity	5...95%, no condensation		
Protection	IP20		
Efficiency	92.7% (110 V AC); 94.5% (230 V AC)	92.8% (110 V AC); 94.3% (230 V AC)	91.7% (110 V AC); 94.1% (230 V AC)
Connection	Push-In spring clamp terminals		
Temperature range	-40...+60 °C, ...+70 °C derating (storage temperature -40...+80 °C)		
Dimension drawing			
Notes			

POWER SUPPLY UNITS

Single-phase

– Short-circuit and overload protected

– Alarm contact

Approvals:  

Emparro®
OUTPUT: 48...56 V DC
Current: 2.5 A



Emparro®
OUTPUT: 48...56 V DC
Current: 5 A



Emparro®
OUTPUT: 48...56 V DC
Current: 10 A



Order Data	Art-No.	Art-No.	Art-No.
48 V DC/2.5 A (for DIN-Rail)	85437		
48 V DC/2.5 A (for screwing)	85722		
48 V DC/5 A (for DIN-Rail)		85438	
48 V DC/5 A (for screwing)		85723	
48 V DC/10 A (for DIN-Rail)			85439
48 V DC/10 A (for screwing)			85724

Input			
Input voltage	85...265 V AC/90...250 V DC		
Input current	1.2 A (100 V AC); 0.6 A (240 V AC)	2.6 A (100 V AC); 1.1 A (240 V AC)	5.1 A (100 V AC); 2.4 A (240 V AC)
Inrush current after 1 ms	max. 3.5 A (230 V AC)	max. 5.5 A (230 V AC)	max. 11 A (230 V AC)
Power factor	0.87 (230 V AC)	0.95 (230 V AC)	0.94 (230 V AC)
Frequency	50..60 Hz		
Input fuse (internal)	6.3 A (T)		10 A (T)
Output			
Output voltage	48 V DC (SELV), ±1%; 48...56 V adjustable		
Power Boost	I _{out} N × 150% (min. 4 s)		
Output current	2.5 A	5 A	10 A
Mains failure bridging time	min. 30 ms (100 V AC); 2.5 A (48 V DC)	min. 30 ms (100 V AC); 5 A (48 V DC)	min. 30 ms (100 V AC); 10 A (48 V DC)
Ripple	max. 50 mVrms		
Spikes	max. 200 mV p-p		
Unit protection	Short-circuit and overload protected		
LED display	LED (green): OK; LED (red): overload, overheating or short-circuit		
Parallel usage/serial usage	max. 5 units/max. 2 units		
General data			
Standards	EN 60950-1, EN 61204-3, EN 55011 B, EN 61000-3-2, SEMI F47		
Relative humidity	5...95%, no condensation		
Protection	IP20		
Efficiency	92.8% (110 V AC); 94.6% (230 V AC)	93.7% (110 V AC); 95.1% (230 V AC)	95%
Connection	Push-In spring clamp terminals		
Temperature range	-40...+60 °C, ...+70 °C derating (storage temperature -40...+80 °C)		

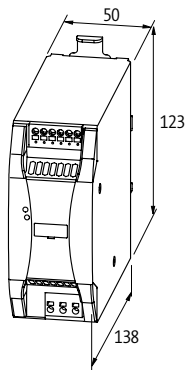
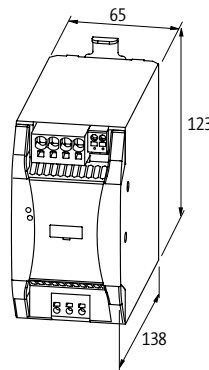
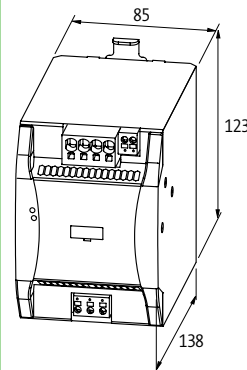
Dimension drawing			
			

Notes

POWER SUPPLY UNITS

Single-phase

– Short-circuit and overload protected

– Alarm contact

Approvals:  

Emparro®

OUTPUT: 12...15 V DC
Current: 10 A



Order Data		Art-No.
12 V DC/10 A (for DIN-Rail)		85434
12 V DC/10 A (for screwing)		85712
Input		
Input voltage	85...265 V AC/90...250 V DC	
Input current	1.2 A (100 V AC); 0.6 A (230 V AC)	
Inrush current after 1 ms	max. 10 A (230 V AC)	
Power factor	0.88 (230 V AC)	
Frequency	50...60 Hz	
Input fuse (internal)	6.3 A (T)	
Output		
Output voltage	12 V DC (SELV), ±1%; 12...15 V adjustable	
Power Boost	I _{out} N × 150% (min. 4 s)	
Output current	10 A	
Mains failure bridging time	min. 30 ms (100 V AC); 10 A (12 V DC)	
Ripple	max. 50 mVrms	
Spikes	max. 200 mV p-p	
Unit protection	Short-circuit and overload protected	
LED display	LED (green): OK; LED (red): overload, overheating or short-circuit	
Parallel usage/serial usage	max. 5 units/max. 2 units	
General data		
Standards	EN 60950-1, EN 61204-3, EN 55011 B, EN 61000-3-2, SEMI F47	
Relative humidity	5...95%, no condensation	
Protection	IP20	
Efficiency	91.4% (110 V AC); 93.2% (230 V AC)	
Connection	Push-In spring clamp terminals	
Temperature range	-40...+60 °C, ...+70 °C derating (storage temperature -40...+80 °C)	
Dimension drawing		

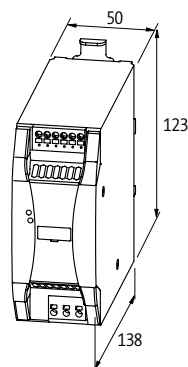

Notes

POWER SUPPLY UNITS

Single-phase

– Short-circuit and overload protected

– IP20

– rugged design

Emparro® HD

OUTPUT: 24...28 V DC

Current: 10 A



Order Data	Art-No.
24 V DC/10 A	85449

Input	
Input voltage	90...265 V AC/90...370 V DC
Input current	1.1 A (240 V AC)
Inrush current after 1 ms	max. 7 A (240 V AC)
Power factor	0.91 (230 V AC)
Frequency	50...60 Hz
Input fuse (internal)	6.3 A (T)

Output	
Output voltage	24 V DC (SELV), $\pm 1\%$; 24...28 V adjustable
Power Boost	15 A (min. 5 s)
Output current	10 A
Mains failure bridging time	min. 35 ms (100 V AC); 10 A (24 V DC)

Ripple	max. 30 mVrms
Spikes	max. 300 mV p-p
Unit protection	Short-circuit and overload protected
LED display	LED (green): OK; LED (red): overload, overheating or short-circuit
Parallel usage/serial usage	max. 3 units/max. 2 units

General data	
Standards	EN 60950-1, EN 61204-3, EN 55022 B, EN 61000-3-2
Relative humidity	5...95%, no condensation
Protection	IP20
Efficiency	93.5% (115 V AC); 94.2% (230 V AC)
MTBF	1 000 000 h
Connection	Spring clamp terminals
Mounting method	screw fixing
Temperature range	-40...+50 °C, ...+80 °C derating (storage temperature -40...+85 °C)

Dimension drawing

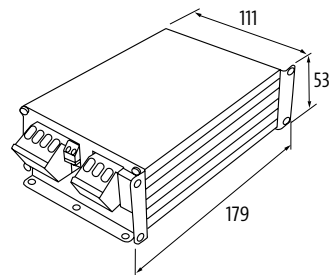

Notes

POWER SUPPLY UNITS

2-/3-phase

– Short-circuit and overload protected

– Alarm contact



Emparro®

OUTPUT: 24...28 V DC
Current: 5 A



Emparro®

OUTPUT: 24...28 V DC
Current: 10 A



Order Data	Art-No.	Art-No.
24 V DC/5 A (for DIN-Rail)	85690	
24 V DC/5 A (for screwing)	85695	
24 V DC/5 A (varnished board)	87690	
24 V DC/10 A (for DIN-Rail)		85691
24 V DC/10 A (for screwing)		85696
24 V DC/10 A (varnished board)		87691

Input		
Input voltage	3 × 324...572 V AC/450...745 V DC	
Input current	0.45 A (3 × 360 V AC); 0.3 A (3 × 500 V AC)	0.75 A (3 × 360 V AC); 0.55 A (3 × 500 V AC)
Inrush current after 1 ms	max. 9.5 A (3 × 500 V AC)	max. 9.0 A (3 × 500 V AC)
Power factor	0.61 (3 × 400 V AC)	0.66 (3 × 500 V AC)
Frequency	50...60 Hz	
Input fuse (internal)	3 × 6.3 A (T)	
Output		
Output voltage	24 V DC (SELV), ±1%; 24...28 V adjustable	
Power Boost	I _{out} N × 150% (min. 5 s)	
Output current	3.7 A (70 °C); 5.0 A (60 °C); 6.0 A (45 °C)	12 A (45 °C); 10 A (60 °C); 7 A (70 °C)
Mains failure bridging time	min. 25 ms (3 × 360 V AC); 5 A (24 V DC)	min. 45 ms (3 × 500 V AC); 10 A (24 V DC)
Ripple	max. 20 mVrms	
Spikes	max. 50 mV p-p	
Unit protection	Short-circuit and overload protected, permanently by 20% (to 45 °C)	
LED display	LED (green): OK; LED (red): overload, overheating or short-circuit	
Parallel usage/serial usage	max. 3 units	
General data		
Standards	EN 60950-1, EN 61204-3, EN 55011 B, EN 61000-3-2, SEMI F47	
Relative humidity	5...95%, no condensation	
Protection	IP20	
Efficiency	92.5% (3 × 400 V AC); 91.8% (3 × 480 V AC)	93.7% (3 × 400 V AC); 93.2% (3 × 480 V AC)
Connection	Push-In spring clamp terminals	
Temperature range	-40...+70 °C, ...+70 °C derating (storage temperature -40...+85 °C)	

Dimension drawing		

Notes		

POWER SUPPLY UNITS

2-/3-phase

– Short-circuit and overload protected

– Alarm contact

Approvals:   

Emparro®

OUTPUT: 24...28 V DC
Current: 20 A



Emparro®

OUTPUT: 24...28 V DC
Current: 40 A



Order Data	Art-No.	Art-No.
24 V DC/20 A (for DIN-Rail)	85692	
24 V DC/20 A (for screwing)	85697	
24 V DC/20 A (varnished board)	87692	
24 V DC/40 A (for DIN-Rail)		85693
24 V DC/40 A (for screwing)		85698
24 V DC/40 A (varnished board)		87693

Input		
Input voltage	3 × 324...572 V AC/450...745 V DC	3 × 324...572 V AC/480...745 V DC
Input current	1.3 A (3 × 360 V AC); 1.0 A (3 × 500 V AC)	2.3 A (3 × 360 V AC); 1.6 A (3 × 500 V AC)
Inrush current after 1 ms	max. 13 A (3 × 500 V AC)	max. 14 A (3 × 500 V AC)
Power factor	0.65 (3 × 500 V AC)	0.88 (3 × 500 V AC)
Frequency	50...60 Hz	
Input fuse (internal)	3 × 6.3 A (T)	
Output		
Output voltage	24 V DC (SELV), ±1%; 24...28 V adjustable	
Power Boost	load N × 150% (min. 5 s)	
Output current	15 A (70 °C); 20 A (60 °C); 24 A (45 °C)	30 A (70 °C); 40 A (60 °C); 48 A (45 °C)
Mains failure bridging time	min. 40 ms (3 × 500 V AC)	

Ripple	max. 20 mVrms	
Spikes	max. 90 mV p-p	
Unit protection	Short-circuit and overload protected, permanently by 20% (to 45 °C)	
LED display	LED (green): OK; LED (red): overload, overheating or short-circuit	
Parallel usage/serial usage	max. 3 units	
General data		
Standards	EN 60950-1, EN 61204-3, EN 55011 B, EN 61000-3-2, SEMI F47	
Relative humidity	5...95%, no condensation	
Protection	IP20	
Efficiency	94.8% (3 × 400 V AC); 94.5% (3 × 480 V AC)	93.7% (3 × 400 V AC); 93.5% (3 × 480 V AC)
Connection	Push-In spring clamp terminals	
Temperature range	-40...+70 °C, ...+70 °C derating (storage temperature -40...+85 °C)	

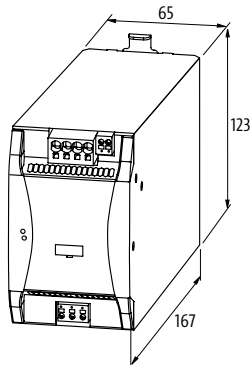
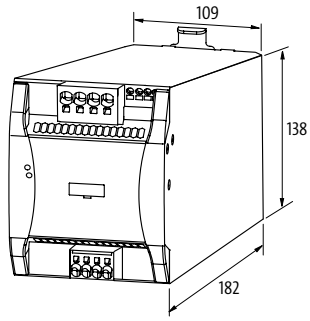
Dimension drawing		
		

Notes		

POWER SUPPLY UNITS

2-/3-phase

- AS-Interface
- Short-circuit and overload protected
- Alarm contact

Approvals:   

Emparro®
OUTPUT: 30...32 V DC



Order Data		Art-No.
30.5 V DC/4 A		85383
Input		
Input voltage	3 × 324...572 V AC/450...745 V DC	
Input current	0.45 A (3 × 360 V AC); 0.3 A (3 × 500 V AC)	
Inrush current after 1 ms	max. 9.5 A (3 × 500 V AC)	
Power factor	0.61 (3 × 400 V AC)	
Frequency	50...60 Hz	
Input fuse (internal)	3 × 6.3 A (T)	
Output		
Output voltage	30.5 V DC (SELV), ±1%; 30...32 V adjustable	
Power Boost	I _{out} N × 150% (min. 5 s)	
Output current	4.8 A (45 °C); 4.0 A (60 °C); 2.9 A (70 °C)	
Mains failure bridging time	min. 20 ms (3 × 360 V AC); 5 A (24 V DC)	
Ripple	max. 20 mVrms	
Spikes	max. 50 mV p-p	
Unit protection	Short-circuit and overload protected, permanently by 20% (to 45 °C)	
LED display	LED (green): OK; LED (red): overload, overheating or short-circuit	
Parallel usage/serial usage	max. 3 units	
General data		
Standards	EN 60950-1, EN 61204-3, EN 61000-3-2, SEMI F47	
Relative humidity	5...95%, no condensation	
Protection	IP20	
Efficiency	92.5% (3 × 400 V AC); 91.8% (3 × 480 V AC)	
Connection	Push-In spring clamp terminals	
Mounting method	DIN-rail mountable TH35 (EN 60715)	
Temperature range	-40...+70 °C, ...+70 °C derating (storage temperature -40...+85 °C)	

Dimension drawing

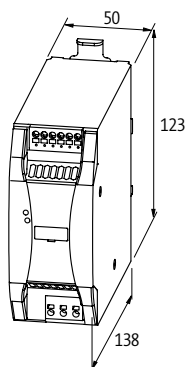

Notes

POWER SUPPLY UNITS

Single-phase

– IP67

Emparro®67

OUTPUT: 24 V DC
Current: 4 A



Emparro®67

OUTPUT: 24 V DC
Current: 8 A

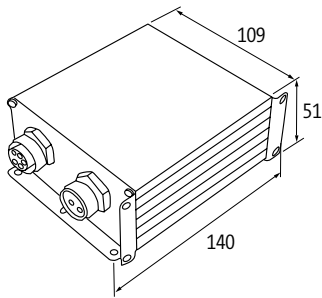
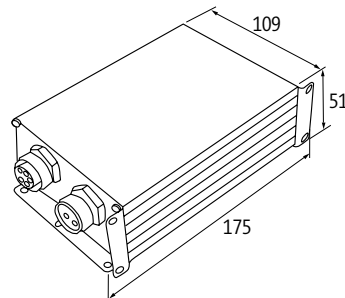

Approvals:  UL US
Listed

Order Data	Art-No.	Art-No.
24 V DC/4 A	9000-11112-1962020	
24 V DC/8 A		9000-11112-2062020
Input		
Input voltage	90...265 V AC/90...265 V DC	
Input current	1.1 A (100 V AC); 0.5 A (240 V AC)	2.1 A (100 V AC); 0.9 A (240 V AC)
Inrush current after 1 ms	max. 8.9 A (230 V AC)	max. 7 A (230 V AC)
Power factor	0.98 (230 V AC)	0.95 (230 V AC)
Connection	7/8" male, 3-pole	
Frequency	50...60 Hz	
Input fuse (internal)	6.3 A (T)	
Output		
Output voltage	24 V DC (SELV), ±2%	
Power Boost	I _{out} N × 150% (min. 4 s)	
Output current	4 A	8 A
Connection	7/8" (female), 5-pole	
Mains failure bridging time	min. 45 ms (230 V AC); 4 A (24 V DC)	min. 35 ms (230 V AC); 8 A (24 V DC)
Ripple	max. 20 mVrms	max. 30 mVrms
Spikes	max. 100 mV p-p	max. 300 mV p-p
Unit protection	Short-circuit, overload and temperature	
LED display	LED (green): OK; LED (red): overload, overheating or short-circuit	
Parallel usage/serial usage	max. 3 units/max. 2 units	
General data		
Standards	EN 60950-1, EN 61204-3, EN 55011 A, EN 61000-3-2	
Relative humidity	4...100%	
Protection	IP67	
Efficiency	91.7% (115 V AC); 92.4% (230 V AC)	93.5% (115 V AC); 94.2% (230 V AC)
Mounting method	screw fixing	
Temperature range	-40...+60 °C, ...+70 °C derating (storage temperature -40...+80 °C)	
Dimension drawing		
		
Notes		

POWER SUPPLY UNITS

Single-phase

- Over current protection device
- 2×MICO 7/8" IOL
- Preventive Diagnostic

IO-Link

Emparro®67 Hybrid

OUTPUT: 24...28 V DC
Current: 10 A



Order Data		Art-No.
24 V DC/10 A		85676
Input		
Input voltage	90...265 V AC/90...265 V DC	
Input current	1.1 A (230 V AC)	
Inrush current after 1 ms	max. 7 A (230 V AC)	
Power factor	0.88 (230 V AC)	
Connection	7/8" male, 3-pole	
Frequency	50...60 Hz	
Input fuse (internal)	6.3 A (T)	
Output		
Output voltage	24 V DC (SELV), ±1%; 24...28 V adjustable	
Output current	max. 8 A (per channel), max. 10 A (total)	
No. of channels	2×MICO (Over current protection device)	
Connection	7/8" (female), 5-pole	
Mains failure bridging time	min. 20 ms (230 V AC)	
Ripple	max. 10 mVrms	
Spikes	max. 150 mV p-p	
Unit protection	Short-circuit, overload and temperature	
LED display	LED (green): OK; LED (red): overload, overheating or short-circuit	
Parallel usage/serial usage	no	
General data		
Standards	EN 60950-1, EN 61204-3, EN 55022 B, EN 61000-3-2	
Relative humidity	4...100%	
Protection	IP67	
Efficiency	91.6% (115 V AC); 92.8% (230 V AC)	
MTBF	430 000 h	
Mounting method	screw fixing	
Temperature range	-25...+50 °C (storage temperature -40...+85 °C)	
Dimension drawing		

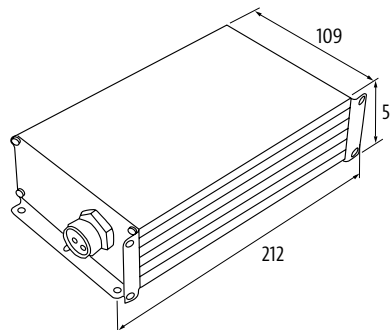

Notes	
	For an explanation of MICO features, see the chapter Intelligent Power Distribution

POWER SUPPLY UNITS

2-/3-phase

– stable output voltage

– Short-circuit and overload protected

Approvals:  

Evolution

OUTPUT: 22...28 V DC
Current: 5 A



Evolution

OUTPUT: 22...28 V DC
Current: 10 A



Order Data	HxWxD/kg	Art-No.	HxWxD/kg	Art-No.
24 V DC/5 A	132x83x98/1.0	85000		
24 V DC/10 A			132x93x114/1.3	85001
Input				
Input voltage	3 x 324...572 V AC/480...745 V DC			
Input current	3 x 0.45 A		3 x 0.8 A	
Inrush current after 1 ms	max. 10 A		max. 15 A	
Frequency	50...60 Hz			
Primary fusing external	max. 3 x 10 A		3 x 10 A (T)	
Output				
Output voltage	24 V DC (SELV), ±1%; 22...28 V adjustable			
Output current	5 A (+55 °C); 3 A (+70 °C)		10 A (+55 °C); 6.5 A (+70 °C)	
Power Boost	I _{out} N x 150% (min. 4 s)			
Mains failure bridging time	min. 30 ms (400 V AC)		min. 19 ms (400 V AC)	
Ripple	max. 50 mVrms			
Spikes	max. 100 mV p-p			
LED display	LED (green): OK; LED (red): overload			
Parallel usage/serial usage	max. 5 units/max. 2 units			
General data				
Standards	EN 60950-1, EN 61204-3, EN 55022 B, EN 61000-3-2, SEMI F47			
Relative humidity	5...95%, no condensation			
Protection	IP20			
Efficiency	86% (3 x 360 V AC); 86% (3 x 520 V AC)		90% (3 x 400 V AC); 90% (3 x 520 V AC)	
Connection	Screw terminals			
Mounting method	DIN-rail mountable TH35 (EN 60715)			
Temperature range	-25...+70 °C (storage temperature -40...+85 °C)			
Dimension drawing				

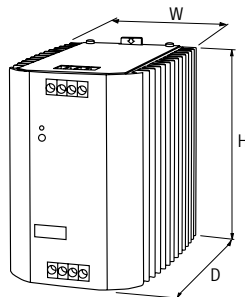

Notes

POWER SUPPLY UNITS

2-/3-phase

- stable output voltage
- Short-circuit and overload protected



Evolution

OUTPUT: 22...28 V DC
Current: 20 A



Evolution

OUTPUT: 22...28 V DC
Current: 40 A



Order Data	H×W×D/kg	Art-No.	H×W×D/kg	Art-No.
24 V DC/20 A	132×113×136/2.0	85002		
24 V DC/40 A			132×164×142/3.0	85004
Input				
Input voltage	3 × 324...572 V AC/480...745 V DC			
Input current	3 × 1.3 A		3 × 2.4 A	
Inrush current after 1 ms	max. 19 A			
Frequency	50...60 Hz			
Primary fusing external	max. 3 × 20 A			
Output				
Output voltage	24 V DC (SELV), ±1%; 22...28 V adjustable			
Output current	20 A (+55 °C); 15.8 A (+70 °C)		40 A (+55 °C); 30 A (+70 °C)	
Power Boost	I _{out} N × 150% (min. 4 s)			
Mains failure bridging time	min. 19 ms (400 V AC)			
Ripple	max. 50 mVrms			
Spikes	max. 100 mV p-p			
LED display	LED (green): OK; LED (red): overload			
Parallel usage/serial usage	max. 5 units/max. 2 units			
General data				
Standards	EN 60950-1, EN 61204-3, EN 55011 A, EN 61000-3-2, SEMI F47		EN 60950-1, EN 61204-3, EN 55022 B, EN 61000-3-2, SEMI F47	
Relative humidity	5...95%, no condensation			
Protection	IP20			
Efficiency	90% (3 × 400 V AC); 89% (3 × 520 V AC)		91% (3 × 400 V AC); 90% (3 × 520 V AC)	
Connection	Screw terminals			
Mounting method	DIN-rail mountable TH35 (EN 60715)			
Temperature range	-25...+70 °C (storage temperature -40...+85 °C)			
Dimension drawing				

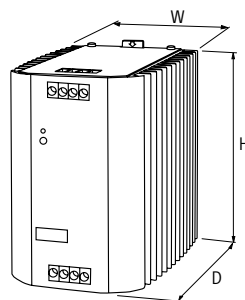

Notes

POWER SUPPLY UNITS

2-/3-phase

– stable output voltage

– Short-circuit and overload protected

– Varnished board

Approvals:  

Evolution+

OUTPUT: 22...28 V DC
Current: 5 A



Evolution+

OUTPUT: 22...28 V DC
Current: 10 A



Order Data	HxWxD/kg	Art-No.	HxWxD/kg	Art-No.
24 V DC/5 A	132x83x98/1.0	85640		
24 V DC/10 A			132x93x114/1.2	85641
Input				
Input voltage	3 x 324...572 V AC/480...745 V DC			
Input current	3 x 0.45 A		3 x 0.8 A	
Inrush current after 1 ms	max. 10 A		max. 15 A	
Frequency	50...60 Hz			
Primary fusing external	3 x 10 A (T)			
Output				
Output voltage	24 V DC (SELV), ±1%; 22...28 V adjustable			
Output current	5 A (+55 °C); 3 A (+70 °C)		10 A (+55 °C); 6.5 A (+70 °C)	
Power Boost	I _{out} N x 150% (min. 4 s)			
Mains failure bridging time	min. 30 ms (400 V AC)		min. 19 ms (400 V AC)	
Ripple	max. 50 mVrms			
Spikes	max. 100 mV p-p			
LED display	LED (green): OK; LED (red): overload			
Parallel usage/serial usage	max. 5 units/max. 2 units			
Alarm output	electronic relay max. 30 V DC/0.1 A, group alarm			
General data				
Standards	EN 60950-1, EN 61204-3, EN 55022 B, EN 61000-3-2, SEMI F47			
Relative humidity	5...95%, no condensation			
Protection	Varnished board			
Protection	IP20			
Efficiency	86% (3 x 400 V AC); 86% (3 x 520 V AC)		90% (3 x 400 V AC); 90% (3 x 520 V AC)	
Connection	Screw terminals			
Mounting method	DIN-rail mountable TH35 (EN 60715)			
Temperature range	-25...+70 °C (storage temperature -40...+85 °C)			

Dimension drawing

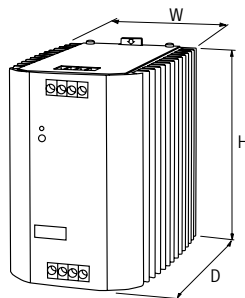

Notes

POWER SUPPLY UNITS

2-/3-phase

- stable output voltage
- Short-circuit and overload protected
- Varnished board



Evolution+

OUTPUT: 22...28 V DC
Current: 20 A



Evolution+

OUTPUT: 22...28 V DC
Current: 40 A



Order Data	H×W×D/kg	Art-No.	H×W×D/kg	Art-No.
24 V DC/20 A	132×113×136/2.0	85642		
24 V DC/40 A			132×164×142/3.0	85644
Input				
Input voltage	3 × 324...572 V AC/480...745 V DC			
Input current	3 × 1.3 A		3 × 2.4 A	
Inrush current after 1 ms	max. 19 A			
Frequency	50...60 Hz			
Primary fusing external	max. 3 × 20 A			
Output				
Output voltage	24 V DC (SELV), ±1%; 22...28 V adjustable			
Output current	20 A (+55 °C); 15.8 A (+70 °C)		40 A (+55 °C); 30 A (+70 °C)	
Power Boost	I _{out} N × 150% (min. 4 s)			
Mains failure bridging time	min. 19 ms (400 V AC)			
Ripple	max. 50 mVrms			
Spikes	max. 100 mV p-p			
LED display	LED (green): OK; LED (red): overload			
Parallel usage/serial usage	max. 5 units/max. 2 units			
Alarm output	electronic relay max. 30 V DC/0.1 A, group alarm			
General data				
Standards	EN 60950-1, EN 61204-3, EN 55011 A, EN 61000-3-2, SEMI F47		EN 60950-1, EN 61204-3, EN 55022 B, EN 61000-3-2, SEMI F47	
Relative humidity	5...95%, no condensation			
Protection	Varnished board			
Protection	IP20			
Efficiency	90% (3 × 400 V AC); 89% (3 × 520 V AC)		91% (3 × 400 V AC); 90% (3 × 520 V AC)	
Connection	Screw terminals			
Mounting method	DIN-rail mountable TH35 (EN 60715)			
Temperature range	-25...+70 °C (storage temperature -40...+85 °C)			
Dimension drawing				

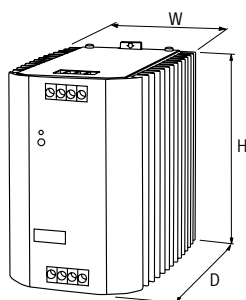

Notes

POWER SUPPLY UNITS

2-/3-phase

– stable output voltage

– Short-circuit and overload protected

– Varnished board

Approvals:  Listed

Evolution+

OUTPUT: 48...56 V DC
Current: 5 A



Evolution+

OUTPUT: 48...56 V DC
Current: 10 A



Evolution+

OUTPUT: 48...56 V DC
Current: 20 A



Order Data	HxWxD/kg	Art-No.	HxWxD/kg	Art-No.	HxWxD/kg	Art-No.
48 V DC/5 A	132x93x114/1.4	85009				
48 V DC/10 A			132x113x136/2.0	85010		
48 V DC/20 A					132x164x142/3.0	85011
Input						
Input voltage	3 x 324...572 V AC/480...745 V DC					
Input current	3 x 0.8 A		3 x 1.3 A		3 x 1.9 A	
Inrush current after 1 ms	max. 9 A		max. 23 A		–	
Frequency	50...60 Hz					
Primary fusing external	max. 3 x 20 A					
Output						
Output voltage	48 V DC (SELV), ±1%; 48...56 V adjustable					
Output current	5 A (+55 °C); 3.73 A (+70 °C)		10 A (+55 °C); 8 A (+70 °C)		20 A (+55 °C); 15 A (+70 °C)	
Power Boost	I _{out} N x 150% (min. 4 s)					
Mains failure bridging time	min. 17 ms (400 V AC)		min. 24 ms (400 V AC)		min. 17 ms (400 V AC)	
Ripple	max. 50 mVrms					
Spikes	max. 100 mV p-p					
LED display	LED (green): OK; LED (red): overload					
Parallel usage/serial usage	max. 5 units/no					
Alarm output	electronic relay max. 30 V DC/0.1 A, group alarm					
General data						
Standards	EN 60950-1, EN 61204-3, EN 55022 B, EN 61000-3-2					
Relative humidity	5...95%, no condensation					
Protection	Varnished board					
Protection	IP20					
Efficiency	91.3% (3 x 360 V AC); 90.5% (3 x 520 V AC)		92.3% (3 x 360 V AC); 91% (3 x 520 V AC)		92.5% (3 x 360 V AC); 90.5% (3 x 520 V AC)	
Connection	Screw terminals					
Mounting method	DIN-rail mountable TH35 (EN 60715)					
Temperature range	-25...+70 °C (storage temperature -40...+85 °C)					

Dimension drawing

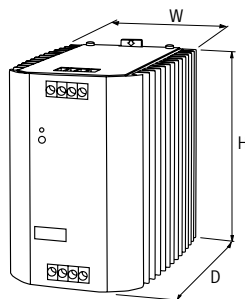

Notes

POWER SUPPLY UNITS

2-/3-phase

- stable output voltage
- Short-circuit and overload protected

Evolution

OUTPUT: 12...13.5 V DC
Current: 20 A



Order Data	H×W×D/kg	Art-No.
12 V DC/20 A	132×93×114/1.3	85016
Input		
Input voltage	3 × 324...572 V AC/480...745 V DC	
Input current	3 × 0.8 A	
Inrush current after 1 ms	max. 15 A	
Frequency	50...60 Hz	
Primary fusing external	3 × 10 A (T)	
Output		
Output voltage	12 V DC (SELV), ±1%; 12...13.5 V adjustable	
Output current	20 A (+55 °C); 15.8 A (+70 °C)	
Power Boost	1out N × 150% (min. 4 s)	
Mains failure bridging time	min. 19 ms (400 V AC)	
Ripple	max. 50 mVrms	
Spikes	max. 100 mV p-p	
LED display	LED (green): OK; LED (red): overload	
Parallel usage/serial usage	max. 5 units/max. 4 units	
Alarm output	electronic relay max. 30 V DC/0.1 A, group alarm	
General data		
Standards	EN 60950-1, EN 61204-3, EN 55022 B, EN 61000-3-2	
Relative humidity	5...95%, no condensation	
Protection	IP20	
Efficiency	89% (3 × 400 V AC); 88% (3 × 520 V AC)	
Connection	Spring clamp terminals	
Mounting method	DIN-rail mountable TH35 (EN 60715)	
Temperature range	-25...+70 °C (storage temperature -40...+85 °C)	
Dimension drawing		

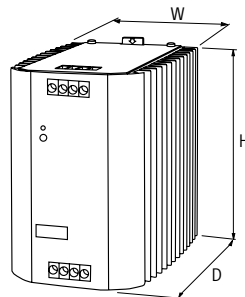

Notes

POWER SUPPLY UNITS

Single-phase

– Short-circuit and overload protected

Approvals: 

Eco-Rail-2

OUTPUT: 23...28 V DC
Current: 1.3 A



Eco-Rail-2

OUTPUT: 23...28 V DC
Current: 2.5 A



Eco-Rail-2

OUTPUT: 23...28 V DC
Current: 5 A

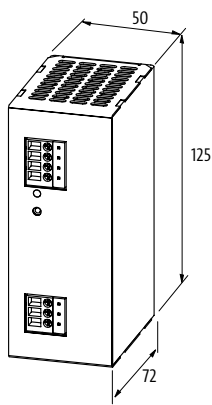
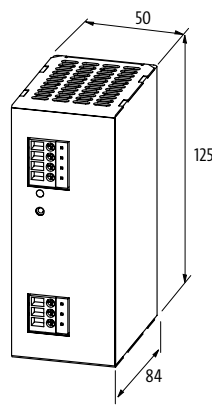
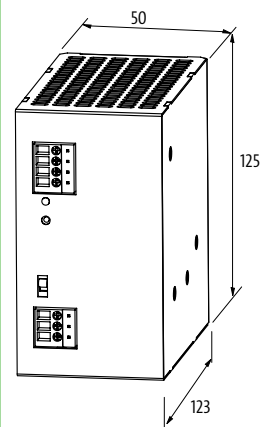

Order Data	Art-No.	Art-No.	Art-No.
24 V DC/1.3 A	85131		
24 V DC/2.5 A		85132	
24 V DC/5 A			85133
Input			
Input voltage	100...240 V AC		
Input current	0.7 A (100 V AC); 0.4 A (240 V AC)	1.3 A (100 V AC); 0.6 A (240 V AC)	2.4 A (100 V AC); 1.2 A (240 V AC)
Inrush current after 1 ms	max. 10 A (230 V AC)		max. 20 A (230 V AC)
Frequency	50...60 Hz		
Input fuse (internal)	2 A (T)	4 A (T)	5 A (T)
Output			
Output voltage	24 V DC \pm 1%; 23...28 V adjustable		
Output current	1.3 A (+40 °C); 1.0 A (+55 °C)	2.5 A (+40 °C); 2.0 A (+55 °C)	5 A (+40 °C); 4 A (+55 °C)
Mains failure bridging time	min. 23 ms (115 V AC); min. 130 ms (230 V AC)	min. 20 ms (115 V AC); min. 100 ms (230 V AC)	min. 45 ms (115 V AC); min. 45 ms (230 V AC)
Ripple	max. 10 mVrms		
Spikes	max. 50 mV p-p		
Unit protection	Short-circuit and overload protected		
LED display	LED (green) for output voltage		
Parallel usage/serial usage	no/yes (max. 2 units)		
General data			
Standards	EN 60950-1, EN 61204-3, EN 61000-3-2		
Relative humidity	20...90%, no condensation		
Protection	IP20		
Efficiency	83% (115 V AC); 84% (230 V AC)	84% (115 V AC); 85% (230 V AC)	87% (115 V AC); 88% (230 V AC)
Connection	Screw terminals		
Mounting method	DIN-rail mountable TH35 (EN 60715)		
Temperature range	0...+40 °C, ...+55 °C derating (storage temperature -20...+85 °C)		
Dimension drawing			
			
Notes			

POWER SUPPLY UNITS

Single-phase

– Short-circuit and overload protected

Approvals:  **UL** US
Listed

Eco-Rail-2

OUTPUT: 23...28 V DC
Current: 10 A



Eco-Rail-2

OUTPUT: 23...28 V DC
Current: 20 A

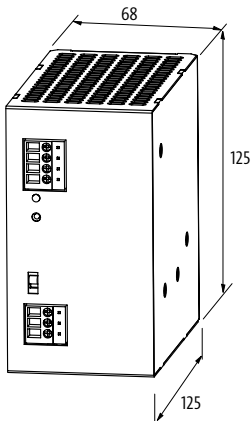
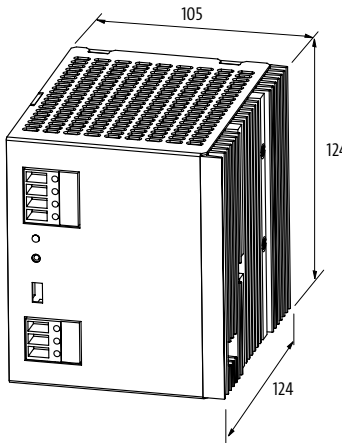

Order Data	Art-No.	Art-No.
24 V DC/10 A	85135	
24 V DC/20 A		85137
Input		
Input voltage	90...132 V AC/173...264 V AC	
Input current	4.3 A (100 V AC); 2.1 A (240 V AC)	7.8 A (100 V AC); 4.0 A (200 V AC)
Inrush current after 1 ms	max. 18 A (230 V AC)	max. 40 A (230 V AC)
Frequency	50...60 Hz	
Input fuse (internal)	5 A (T)	12 A (T)
Output		
Output voltage	24 V DC \pm 1%; 23...28 V adjustable	
Output current	10 A (+40 °C); 7.5 A (+55 °C)	20 A (+40 °C); 16 A (+55 °C)
Mains failure bridging time	min. 12 ms (115 V AC); min. 30 ms (230 V AC)	min. 15 ms (115 V AC); min. 20 ms (230 V AC)
Ripple	max. 10 mVrms	max. 50 mVrms
Spikes	max. 50 mV p-p	max. 100 mV p-p
Unit protection	Short-circuit and overload protected	
LED display	LED (green) for output voltage	
Parallel usage/serial usage	no/yes (max. 2 units)	
General data		
Standards	EN 60950-1, EN 61204-3, EN 61000-3-2	
Relative humidity	20...90%, no condensation	
Protection	IP20	
Efficiency	86% (115 V AC); 87% (230 V AC)	89% (115 V AC); 90% (230 V AC)
Connection	Screw terminals	
Mounting method	DIN-rail mountable TH35 (EN 60715)	
Temperature range	0...+40 °C, ...+55 °C derating (storage temperature -20...+85 °C)	
Dimension drawing		
		
Notes		

POWER SUPPLY UNITS

Single-phase

– Short-circuit and overload protected

Approvals:  

Picco

OUTPUT: 24...28 V DC
Current: 0.42 A



Picco

OUTPUT: 24...28 V DC
Current 1.25 A



Picco

OUTPUT: 24...28 V DC
Current: 2.5 A



Picco

OUTPUT: 24...28 V DC
Current: 4.2 A

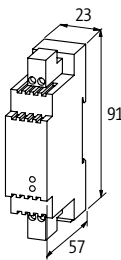
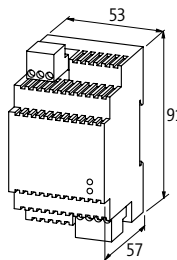
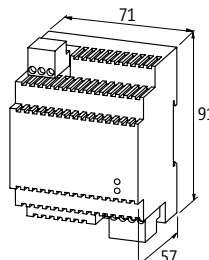
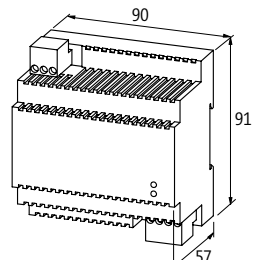

Order Data	Art-No.	Art-No.	Art-No.	Art-No.
Screw terminals	87011	87013	87015	87017
Spring clamp plug-in terminals	87111	87113	87115	87117
Input				
Input voltage	100...240 V AC/120...370 V DC			
Input current	0.2 A (115 V AC); 0.12 A (230 V AC)	0.6 A (115 V AC); 0.4 A (230 V AC)	1.1 A (115 V AC); 0.6 A (230 V AC)	1.7 A (115 V AC); 1 A (230 V AC)
Inrush current after 1 ms	max. 30 A	max. 40 A	max. 60 A	
Frequency	50...60 Hz			
Primary fusing external	max. 10 A		max. 16 A	max. 10 A
Output				
Output voltage	24 V DC (SELV), ±1%; 24...28 V adjustable			
Output current	0.42 A (+50 °C); 0.042 A (+70 °C)	1.25 A (+50 °C); 0.125 A (+70 °C)	2.5 A (+50 °C); 0.25 A (+70 °C)	4.2 A (+50 °C); 0.42 A (+70 °C)
Mains failure bridging time	10...25 ms (115 V AC)			
Ripple	max. 20 mVrms			
Spikes	max. 100 mV p-p			
Unit protection	Short-circuit and overload protected			
LED display	LED (green) for output voltage			
Parallel usage/serial usage	max. 5 units/max. 2 units			
General data				
Standards	EN 60950-1, EN 61204-3, EN 55022 B, EN 61000-3-2			
Relative humidity	20...90%, no condensation			
Protection	IP20			
Efficiency	79% (110 V AC); 80% (230 V AC)	86% (110 V AC); 88% (230 V AC)		
Mounting method	DIN-rail mountable TH35 (EN 60715)			
Temperature range	0...+50 °C, ...+60 °C derating (storage temperature -25...+85 °C)			
Dimension drawing				
				
Notes				

POWER SUPPLY UNITS

Single-phase

– Short-circuit and overload protected

Approvals:

Picco

OUTPUT: 12...15 V DC
Current: 0.85 A



Picco

OUTPUT: 12...15 V DC
Current: 2.5 A



Picco

OUTPUT: 12...15 V DC
Current: 4.5 A





Picco

OUTPUT: 12...15 V DC
Current: 6 A



Order Data	Art-No.	Art-No.	Art-No.	Art-No.
Screw terminals	87012	87014	87016	87018
Spring clamp plug-in terminals	87112	87114	87116	87118
Input				
Input voltage	100...240 V AC/120...370 V DC			
Input current	0.2 A (115 V AC); 0.12 A (230 V AC)	0.6 A (115 V AC); 0.4 A (230 V AC)	1 A (115 V AC); 0.58 A (230 V AC)	1.3 A (115 V AC); 0.75 A (230 V AC)
Inrush current after 1 ms	max. 30 A	max. 40 A	max. 60 A	
Frequency	50...60 Hz			
Primary fusing external	max. 10 A		max. 16 A	max. 10 A
Output				
Output voltage	12 V DC (SELV), ±1%; 12...15 V adjustable			
Output current	0.85 A (+50 °C); 0.085 A (+70 °C)	2.5 A (+50 °C); 0.25 A (+70 °C)	4.5 A (+50 °C); 0.45 A (+70 °C)	6 A (+50 °C); 0.6 A (+70 °C)
Mains failure bridging time	10...25 ms (115 V AC)			
Ripple	max. 20 mVrms			
Spikes	max. 100 mV p-p			
Unit protection	Short-circuit and overload protected			
LED display	LED (green) for output voltage			
Parallel usage/serial usage	max. 5 units/max. 2 units			
General data				
Standards	EN 60950-1, EN 61204-3, EN 55022 B, EN 61000-3-2			
Relative humidity	20...90%, no condensation			
Protection	IP20			
Efficiency	86% (110 V AC); 88% (230 V AC)			
Mounting method	DIN-rail mountable TH35 (EN 60715)			
Temperature range	0...+50 °C, ...+60 °C derating (storage temperature -25...+85 °C)			
Dimension drawing				
Notes				

POWER SUPPLY UNITS

Mounting accessories			Art-No.
	Label plates KES 20 × 8 (white)	(10 pieces/2 plates)	996067
	DIN-Rail Clip DIN-rail mountable TH35 (EN 60715)		85148

Power Supply Units

UPS SYSTEMS / BUFFER / REDUNDANCY MODULES

- Stable power supply
- Protection of processes
- Increase of machine availability

UPS MODULE OR BUFFER MODULE ON THE BASIS OF CAPACITORS?

The UPS module Emparro ACCUcontrol is the right solution if a longer power failure have to be bridged without having to deal with failures and downtimes in production. Thanks to the externally connected lead battery, even a bridging time of several hours is possible.

Emparro Cap works based on ultra condensers, is maintenance-free for its entire service life and is the right solution if a certain amount of power is required to shut machines and control systems down in a structured manner.

Project matrix

Load current	Seconds		Minutes						Hours			
	1	16	1	2	5	10	15	30	1	3	5	10
0.5A	●	●	●	●	●	●	●	●	●	●	●	●
1A	●	●	●	●	●	●	●	●	●	●	●	●
2A	●	●	●	●	●	●	●	●	●	●	●	●
5A	●	●	●	●	●	●	●	●	●	●	●	
10A	●	●	●	●	●	●	●	●	●			
15A	●	●	●	●	●	●	●	●	●			
20A	●	●	●	●	●	●	●	●				
40A	●	●	●	●	●	●	●					

- MB Cap 20 A/0.2 s
- MB Cap Ultra 3 A/7 s
- MB Cap Ultra 10 A/38 s
- Emparro Cap 20 A/1.0 s
- MB Cap Ultra 20 A/16 s
- MB Cap Ultra 40 A/3.6 s
- Emparro ACCUControl 20 A
- Emparro ACCUControl 40 A

UPS systems / Buffer / Redundancy modules



UPS systems

- Predictive Maintenance
- Mini USB for connection to an industrial PC

Page 1.3.1



Buffer modules

- Maintenance-free ultra capacitors
- Buffer time more than 1 second at full load of 20 A
- Metal housing

Page 1.3.2



Buffer modules

- Maintenance-free ultra capacitors

Page 1.3.3



Redundancy modules

Page 1.3.6

UPS-SYSTEMS / BUFFER- / REDUNDANCY MODULES

UPS systems

Emparro® ACCUcontrol

Emparro® ACCUcontrol



Approvals:  UL Listed

Circuit diagram

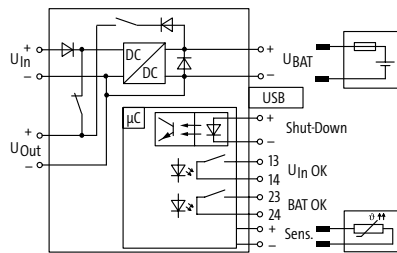

Order Data

24 V DC/20 A

Art-No.

85414

Art-No.

24 V DC/40 A

85415

Technical Data

Sensor type: KTY 81-210 (Art.No. 89600)
 Battery type: Lead battery (max. 40 Ah, sealed)

Input

Input voltage: 21.6...30 V DC (buffer operation)
 Input current: max. 23 A | max. 43 A
 Loading current: 2 A

Output

Output voltage: 27.7...19.2 V DC
 Output current: max. 20 A | max. 40 A

Control inputs

Input voltage shutdown (SH): 24 V DC (6...45 V DC), potential free

Control outputs

Battery (BAT OK): min. 5 V DC, 1 mA; max. 30 V DC, 100 mA
 Input voltage (Uin OK): min. 5 V DC, 1 mA; max. 30 V DC, 100 mA

General data

Connection: Push-In Spring clamp terminals, Mini-USB
 Mounting method: DIN-rail mountable TH35-7.5/TH35-15 (EN 60715)
 Temperature range: -25...+45 °C

Dimension drawing

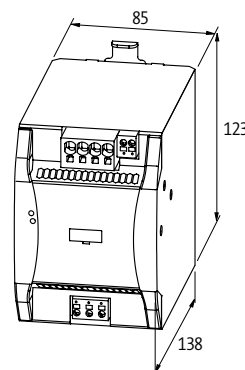
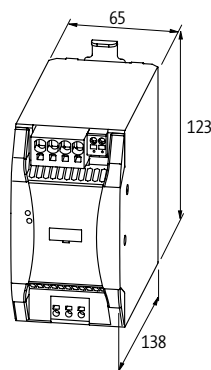

Notes

The required batteries can be found at the end of chapter 1.3.

UPS-SYSTEMS / BUFFER- / REDUNDANCY MODULES

Buffer modules

Emparro® Cap 20/24 1.0s

1.0 s (20 A); 40 s (1 A)



Emparro® Cap 20/48 0.1s

0.1 s (20 A); 2 s (1 A)



Approvals:  UL US
Listed

Circuit diagram

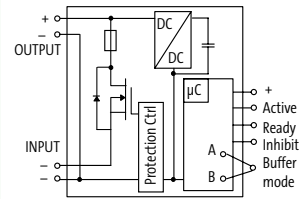
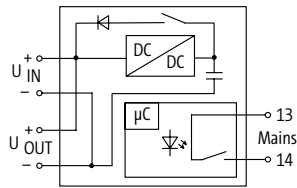

Order Data	Art-No.	Art-No.
24 V DC/20 A	85458	
48 V DC/20 A		85459
Input		
Input voltage	21.6...26.4 V DC	46...56 V DC (SELV/PELV)
Input current	20 A	60 mA
Inrush current	max. 25 A	–
Protection of voltage spikes	–	max. 72 V DC
Loading time	max. 75 s	20...45 s
Loading current	max. 3 A	max. 500 mA
Output		
Output voltage	25.5...19 V DC ±2%	48 V DC (46...56 V DC)
Output current	max. 20 A	
Current limit	65 A	26 A
Buffer time	1.0 s (20 A); 40 s (1 A)	0.1 s (20 A); 2 s (1 A)
Parallel circuit	possible	
Ripple	–	max. 200 mV p-p
General data		
Standards	EN 61000-6-2, EN 61000-6-4	EN 61000-6-2, EN 61000-6-3, EN 55022 B
Mounting method	DIN-rail mountable TH35-7.5/TH35-15 (EN 60715)	DIN-rail mountable TH35 (EN 60715)
Efficiency	90%	99%
Temperature range	-40...+60 °C (storage temperature -40...+60 °C)	-25...+60 °C, ...+70 °C derating (storage temperature -40...+85 °C)
Dimension drawing		

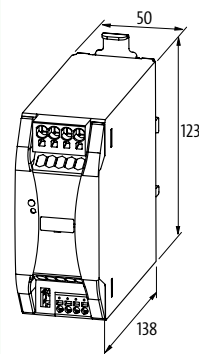
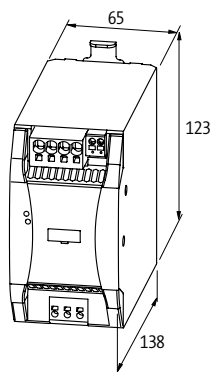

Notes

UPS-SYSTEMS / BUFFER- / REDUNDANCY MODULES

Buffer modules

MB Cap Ultra 3/24 7s

7 s (3 A); 21 s (1 A)



MB Cap Ultra expansion module 3/24 12s

12 s (3 A); 36 s (1 A)



Approvals:  UL^{us}
Listed

Circuit diagram

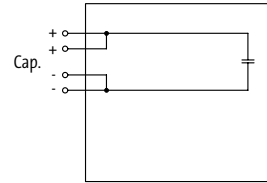
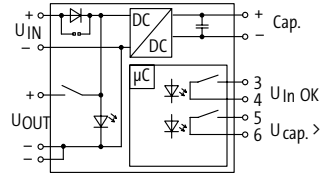

Order Data

24 V DC/3 A

Art-No.

85460

use with Art-No. 85460

Art-No.

85462

Input

Input voltage

20.4...26.4 V DC

0...26.4 V DC

Input current

3 A

Loading time

min. 25 s

–

Output

Output voltage

23 V DC $\pm 2\%$

0...26.4 V DC

Output current

max. 3 A (+60 °C)

Buffer time

7 s (3 A); 21 s (1 A)

12 s (3 A); 36 s (1 A)

General data

Standards

EN 60950, EN 50178, SELV/PELV

Mounting method

DIN-rail mountable TH35 (EN 60715)

Efficiency

90%

Temperature range

-20...+60 °C (storage temperature -20...+60 °C)

Dimension drawing

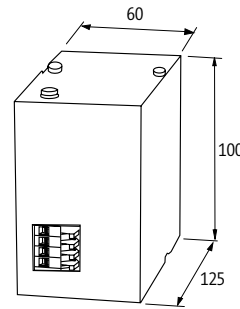
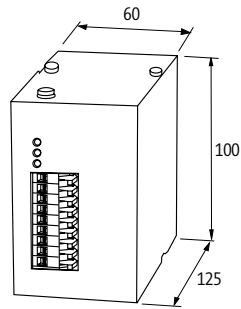

Notes

UPS-SYSTEMS / BUFFER- / REDUNDANCY MODULES

Buffer modules

MB Cap Ultra 10/24 38s

38 s (10 A); 380 s (1 A)



MB Cap Ultra 20/24 16s

16 s (20 A); 320 s (1 A)



MB Cap Ultra 40/24 3.6s

3.6 s (40 A); 170 s (1 A)



Approvals: UL US Listed

Circuit diagram

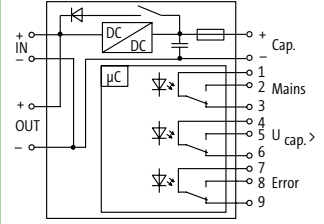
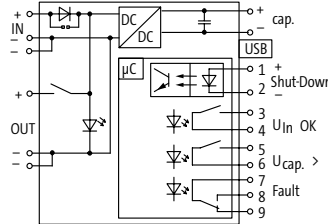
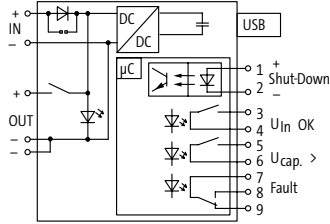

Order Data	Art-No.	Art-No.	Art-No.
24 V DC/10 A	85467		
24 V DC/20 A		85468	
24 V DC/40 A			85469
Input			
Input voltage	10.5...15 V DC; 24...27 V DC	24...29 V DC	21.6...26.4 V DC
Input current	10 A	20 A	40 A
Inrush current	max. 35 A/2 ms	max. 36.5 A/2 ms	max. 36.5 A
Loading time	typ. 100 s; max. 210 s	typ. 40 s; max. 500 s	typ. 140 s; max. 300 s
Output			
Output voltage	11.3 V DC ±4%; 23.3 V DC ±2%	23.3 V DC ±2%	25.5...19 V DC ±2%
Output current	max. 10 A (+60 °C)	max. 20 A (+60 °C)	max. 40 A (+60 °C)
Buffer time	38 s (10 A); 380 s (1 A)	16 s (20 A); 320 s (1 A)	3.6 s (40 A); 170 s (1 A)
General data			
Standards	EN 60950, EN 50178, SELV/PELV	EN 60950-1, EN 61204-3, EN 55011 A	EN 61000-6-2, EN 61000-6-4
Mounting method	DIN-rail mountable TH35-7.5/TH35-15 (EN 60715)		
Efficiency	90%		
Temperature range	-20...+60 °C (storage temperature -20...+60 °C)		
Dimension drawing			

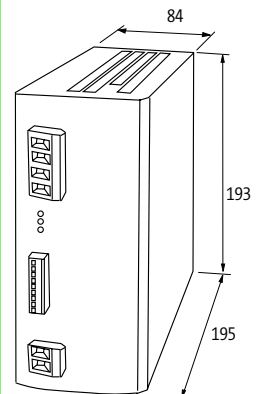
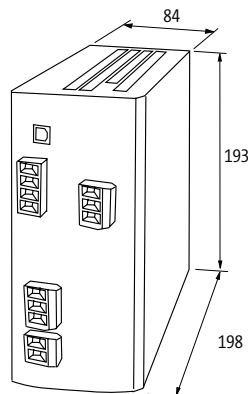
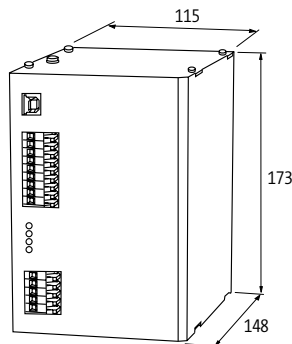

Notes

UPS-Systems / Buffer- / Redundancy Modules

UPS-SYSTEMS / BUFFER- / REDUNDANCY MODULES

Buffer modules

MB Cap 20/24 0.2s

0.2 s (20 A); 4 s (1 A)



Approvals:  UL^{us}
Listed

Circuit diagram

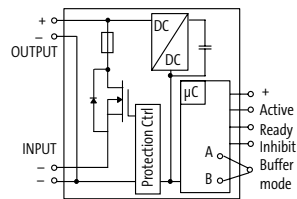

Order Data

24 V DC/20 A

Art-No.

85394

Input

Input voltage 23...30 V DC (SELV/PELV)

Input current 85 mA

Protection of voltage spikes max. 35 V DC

Loading time 20...45 s

Loading current max. 500 mA

Output

Output voltage 24 V DC (22...28 V DC)

Output current max. 20 A (+70 °C)

Current limit 26 A

Buffer time 0.2 s (20 A); 4 s (1 A)

Ripple max. 200 mV p-p

Parallel circuit possible

General data

Standards EN 61000-6-2, EN 61000-6-3, EN 55022 B, EN 60950-1, SELV

Mounting method DIN-rail mountable TH35 (EN 60715)

Efficiency 95%

Temperature range 0...+70 °C (storage temperature -25...+85 °C)

Dimension drawing

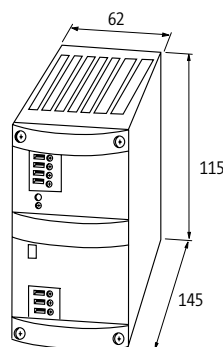

Notes

UPS-SYSTEMS / BUFFER- / REDUNDANCY MODULES

Redundancy modules

MB Redundancy Balance 2 × 20/24

MB Redundancy Balance 2 × 20/24

Auto-Balancing (50/50)



Approvals:  

Circuit diagram

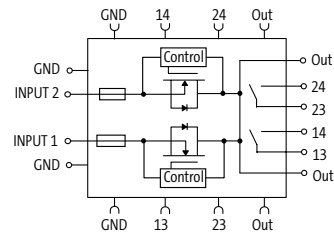
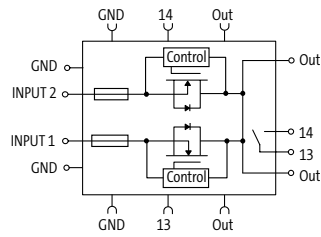

Order Data	Art-No.	Art-No.
24 V DC/2 × 20 A/1 × 40 A	85495	85496

Input		
Input voltage	24 V DC (18...30 V DC)	
Input current	2 × 20 A	
Total current	max. 40 A	
Invers-polarity protection	max. 30 V DC	
Auto-Balancing (50/50)	no	yes
Output		
Output voltage	24 V DC (18...30 V DC)	
Output current	26 A (-25...+40 °C)	
LED display	LED (red/green)	
Parallel usage/serial usage	2 units: 40 A (-25...+60 °C); 52 A (-25...+40 °C)/-	
Alarm output	potential free (relay contact) for input voltage	potential free (relay contact) for input voltage/load distribution

General data		
Standards	EN 61000-6-2, EN 61000-6-3	
Bridging concept	two sides, with spring clamp terminals or bridge set (max. 40 A)	
Relative humidity	5...95%, no condensation	
Efficiency	99.5%	
Connection	Spring clamp terminals	
Mounting method	DIN-rail mountable TH35 (EN 60715)	
Temperature range	-25...+60 °C (storage temperature -40...+85 °C)	

Dimension drawing

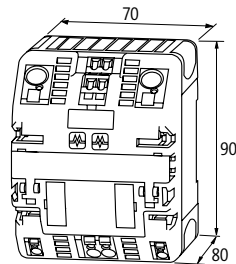

Notes

UPS-Systems / Buffer- / Redundancy Modules

UPS-SYSTEMS / BUFFER- / REDUNDANCY MODULES

Redundancy modules

MB Diode

Approvals:  UL Listed



Circuit diagram

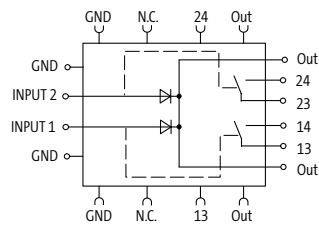

Order Data

24 V DC/2 × 20 A/1 × 40 A

Art-No.

85396

Input

Input voltage	24 V DC (21...30 V DC)
Input current	2 × 20 A/1 × 40 A
Total current	max. 40 A
Invers-polarity protection	internal protection against reverse polarization up to 60 V DC
Auto-Balancing (50/50)	no

Output

Output voltage	24 V DC (21...30 V DC)
Output current	20 A (-25...+55 °C); 40 A (-25...+40 °C)
Overload	at 20 A +50% for 4 s
LED display	LED (green)
Alarm output	potential free per channel (relay contact)

General data

Standards	EN 61000-6-2, EN 61000-6-3
Bridging concept	two sides, with spring clamp terminals or bridge set (max. 40 A)
Relative humidity	5...95%, no condensation
Power loss	U (approx. 0.5 V) × I
Efficiency	97%
Connection	Spring clamp terminals
Mounting method	DIN-rail mountable TH35 (EN 60715)
Temperature range	-25...+55 °C (storage temperature -25...+85 °C)

Dimension drawing

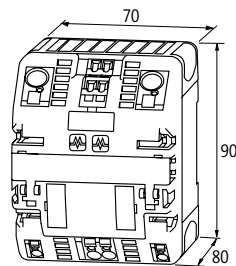

Notes

UPS-SYSTEMS / BUFFER- / REDUNDANCY MODULES

Accessories			Art-No.
	Lead battery 1.2 Ah 96×69×105 mm/2 kg	for Emparro® ACCUcontrol	89550
	Lead battery 7 Ah 115×174.5×159 mm/2.32 kg	for Emparro® ACCUcontrol	89552
	Lead battery 12 Ah 115×240.5×159 mm/3.7 kg	for Emparro® ACCUcontrol	89553
	Lead battery 17 Ah 170×155×182 mm/18 kg	for Emparro® ACCUcontrol	89554
	Lead battery 24 Ah 137×335×200 mm/20 kg	for Emparro® ACCUcontrol	89555



MICO INTELLIGENT POWER DISTRIBUTION

- Monitor
- Detect
- React

FIRST CLASS POWER DISTRIBUTION

MICO is the intelligent power distribution module from Murrelektronik for 24 VDC. It monitors currents, indicates when approaching the maximum load and make targeted circuit isolations during overload or short circuit conditions. This makes sure systems run at maximum capacity.

- Convenient handling – installation without tools
- Diagnosis on location or via the controller
- Patented tripping characteristics for optimal switch-off time

Mico Pro®



Mico Pro® PM

- Power module
- Cover plate included
- Cumulative signal output

Page 1.4.1



Mico Pro® PD

- Potential distributor
- Multiplication of secured channels or potentials

Page 1.4.1



Mico Pro® fix

- Preset current ranges
- Preventive diagnostics

Page 1.4.2



Mico Pro® flex

- Adjustable current ranges
- Channels with remote switch on/off function
- Preventive diagnostics

Page 1.4.3

MICO



MICO+

- Adjustable current ranges
- Channels with remote switch on/off function
- Preventive diagnostics

Page 1.4.4



MICO

- Adjustable current ranges
- Channels with remote switch on function
- Group alarm output

Page 1.4.6



MICO BASIC

- Preset current ranges
- Small size

Page 1.4.10



MICO FUSE

- Socket for glass tube fuses 5 × 20 mm

Page 1.4.13

EXAMPLE: Why don't circuit breakers trigger reliably in a 24 VDC system?

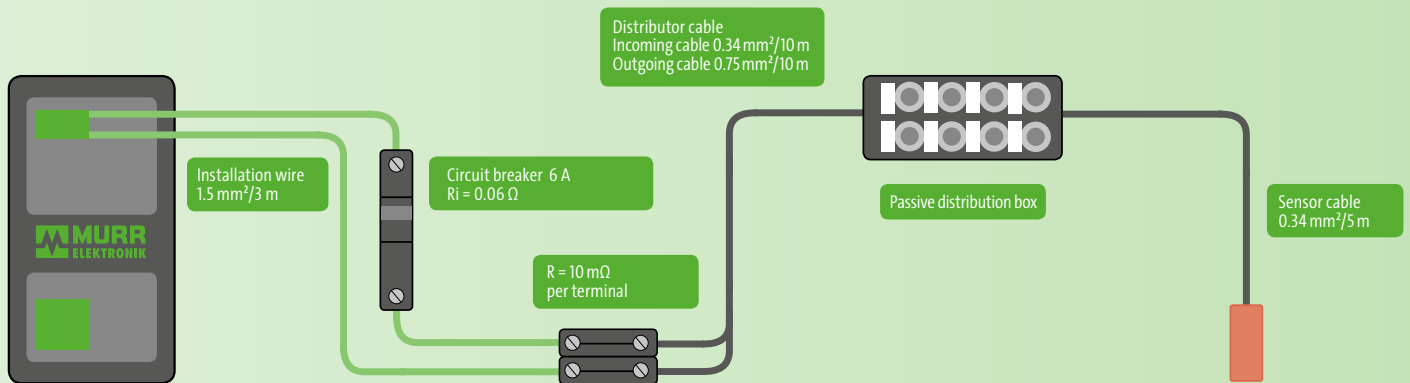

Specific resistance of copper (ρ)		= 0.0178 ($\Omega \times \text{mm}^2 / \text{m}$)
Wire resistance:	$R = \frac{(\rho) \times l}{A}$	= $\frac{0.0178 \times (2 \times 3 \text{ m})}{1.5 \text{ mm}^2} = 0.07 \Omega$
Distributor cable resistance:	$R = \frac{(\rho) \times l}{A}$	= $\frac{0.0178 \times (2 \times 10 \text{ m})}{(0.34 + 0.75 \text{ mm}^2) / 2} = 0.65 \Omega$
Sensor cable resistance:	$R = \frac{(\rho) \times l}{A}$	= $\frac{0.0178 \times (2 \times 5 \text{ m})}{0.34 \text{ mm}^2} = 0.52 \Omega$
Inner resistance of circuit breaker and connection terminals		= 0.08 Ω
Total loop resistance		= 1.32 Ω

Calculation of maximum possible current flow $I = \frac{U}{R} = \frac{24 \text{ V}}{1.32 \Omega} = \underline{\underline{18.18 \text{ A}}}$
(limited by loop resistance)

Required tripping current of the 6 A circuit breaker Type C
 $14 \times I_{\text{Nenn}} = 14 \times 6 \text{ A} = \underline{84 \text{ A}}$



Tripping current Max. current flow
 84 A > 18.18 A

INTELLIGENT POWER DISTRIBUTION

Over current protection device

– Power supplies

Mico Pro® PM 24 V DC/40 A

Power module
Cover plate included



Mico Pro® PD 2x12

Potential distributor
1 channel (x11)



Mico Pro® PD 2x2x06

Potential distributor
2 channels per (x5)

Approvals:

Order Data	Art-No.	Art-No.	Art-No.
40 A	9000-41190-0000000		
20 A		9000-41000-0000212	
2 x 20 A			9000-41000-0002206
Input			
Operating voltage	12 V DC; 24 V DC (9...30 V DC)	12 V DC, 24 V DC	
Total current	max. 40 A	max. 20 A	max. 2 x 20 A
Output			
Parallel usage/serial usage	-/Selectivity in 2 levels	–	
Control inputs			
Input voltage (ON)	9...30 V DC	–	
Impulse length (ON)	"high" 120 ms	–	
Input voltage (CTRL)	9...30 V DC	–	
Impulse length (CTRL)	OFF "high" 40/400 ms, ON "high" 20/200 ms	–	
Control outputs			
Early warning (90%)	max. 30 V AC/DC	–	
Group alarm output	max. 30 V AC/DC	–	
Connections (IN)			
Connection	Bridge system		
Connections (OUT)			
Connection	Push-In spring clamp terminals		
Cross section (rigid)	0.75...16 mm ² (AWG 20...4)	0.2...2.5 mm ² (AWG 24...14)	
Cross section (flex)	0.75...16 mm ² (AWG 20...4)	0.2...2.5 mm ² (AWG 24...14)	
General data			
Protection	IP20		
Bridging concept	Bridge set (max. 40 A)		
Mounting method	DIN-rail mountable TH35 (EN 60715)		
Temperature range	-25...+55 °C (storage temperature -40...+80 °C)		
Dimensions H x W x D	130x24x114 mm		

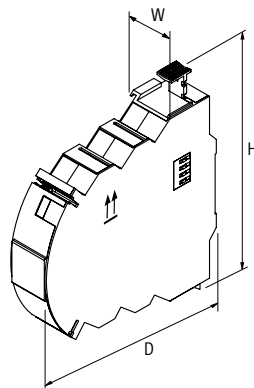

Notes

INTELLIGENT POWER DISTRIBUTION

Over current protection device

– preset current ranges

Approvals:   

Mico Pro® fix
1 channel



Mico Pro® fix
1 channel



Mico Pro® fix
2 channels



Mico Pro® fix
4 channels



Order Data	Art-No.	Art-No.	Art-No.	Art-No.
2 A	9000-41011-0200000		9000-41012-0200000	9000-41014-0200000
4 A	9000-41011-0400000		9000-41012-0400000	9000-41014-0400000
6 A	9000-41011-0600000		9000-41012-0600000	9000-41014-0600000
8 A	9000-41011-0800000			
10 A	9000-41011-1000000			
16 A		9000-41011-1600000		
Input				
Operating voltage	12 V DC; 24 V DC (9...30 V DC)			
Total current	max. 40 A			
Output				
No. of channels	1		2	4
Inrush capacity	max. 30 mF			
Tolerance	0...+20%			
Parallel usage/serial usage	-/Selectivity in 2 levels			
Control inputs				
Input voltage (ON)	via power module			
Impulse length (ON)	via power module			
Input voltage (CTRL)	via power module			
Impulse length (CTRL)	via power module			
Control outputs				
Group alarm output	via power module			
Early warning (90%)	via power module			
Connections (IN)				
Connection	Bridge system			
Connections (OUT)				
Connection	Push-In spring clamp terminals			
Cross section (rigid)	0.2...2.5 mm ² (AWG 24...14)			
Cross section (flex)	0.2...4 mm ² (AWG 24...12)			
General data				
Protection	IP20			
Bridging concept	Bridge set (max. 40 A)			
Mounting method	DIN-rail mountable TH35 (EN 60715)			
Temperature range	-25...+55 °C (storage temperature -40...+80 °C)			
Dimensions H × W × D	130×8×114 mm	130×12×114 mm	130×24×114 mm	
Dimension drawing				

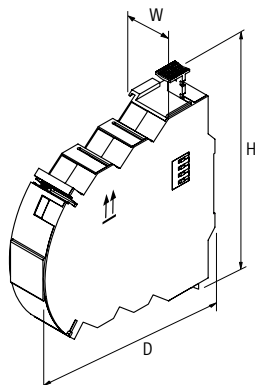

INTELLIGENT POWER DISTRIBUTION

Over current protection device

- adjustable current ranges
- channel-specific messages

Approvals:

Mico Pro® flex

1 channel



Mico Pro® flex

1 channel



Mico Pro® flex

2 channels



Mico Pro® flex

4 channels



Order Data	Art-No.	Art-No.	Art-No.	Art-No.
1, 2, 3, 4, 5, 6, 7, 8, 9, 10 A	9000-41091-0101000		9000-41092-0101000	9000-41094-0101000
11, 12, 13, 14, 15, 16, 17, 18, 19, 20 A		9000-41091-1102000		
Input				
Operating voltage	12 V DC; 24 V DC (9...30 V DC)			
Total current	max. 40 A			
Output				
No. of channels	1		2	4
Inrush capacity	max. 30 mF			
Tolerance	0...+20%	-5...+15 %	0...+20%	
Parallel usage/serial usage	-/Selectivity in 2 levels			
Control inputs				
Input voltage (ON)	9...30 V DC			
Impulse length (ON)	"high" 120 ms			
Input voltage (CTRL)	9...30 V DC			
Impulse length (CTRL)	OFF "high" 40/400 ms, ON "high" 20/200 ms			
Control outputs				
Group alarm output	via power module			
Early warning (90%)	like operating voltage - max. 20 mA, via power module			
Connections (IN)				
Connection	Bridge system			
Connections (OUT)				
Connection	Push-In spring clamp terminals			
Cross section (rigid)	0.2...2.5 mm ² (AWG 24...14)			
Cross section (flex)	0.2...4 mm ² (AWG 24...12)			
General data				
Protection	IP20			
Bridging concept	Bridge set (max. 40 A)			
Mounting method	DIN-rail mountable TH35 (EN 60715)			
Temperature range	-25...+55 °C (storage temperature -40...+80 °C)	-25...+50 °C (storage temperature -40...+80 °C)	-25...+55 °C (storage temperature -40...+80 °C)	
Dimensions H × W × D	130×8×114 mm	130×12×114 mm	130×24×114 mm	

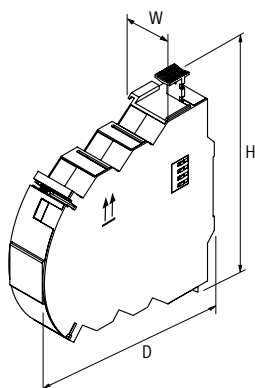

Notes

INTELLIGENT POWER DISTRIBUTION

Over current protection device

- adjustable current ranges
- early warning (90%)

Approvals:   

MICO+ 4.4

4 channels



MICO+ 4.6

4 channels

Order Data	Art-No.	Art-No.
1 A, 2 A, 3 A, 4 A	9000-41084-0100400	
1 A, 2 A, 4 A, 6 A		9000-41084-0100600
Input		
Operating voltage	24 V DC (18...30 V DC)	
Output		
Current adjustment	1 A, 2 A, 3 A, 4 A, by countersunk rotary switch, sealed	1 A, 2 A, 4 A, 6 A, by countersunk rotary switch, sealed
Inrush capacity	max. 20 mF (per channel)	
Control inputs		
Input voltage (ON)	10...30 V DC	
Remote start (OFF)	10...30 V DC	
Impulse length (ON)	min. 20 ms	
Control outputs		
Group alarm output	max. 20 mA; high: all channels ON; low: not all channels ON	
Early warning (90%)	max. 20 mA; high: one channel over 90%; low: all channels under 90%	
General data		
Connection	Spring clamp terminals	
Input terminals	2 × 16 mm ²	
Output terminals	per output 2 × 1.5 mm ²	
Alarm terminals	2.5 mm ²	
Bridging concept	two sides, with spring clamp terminals or bridge set (max. 40 A)	
Mounting method	DIN-rail mountable TH35 (EN 60715)	
Temperature range	0...+55 °C (storage temperature -40...+80 °C)	
Dimension drawing		

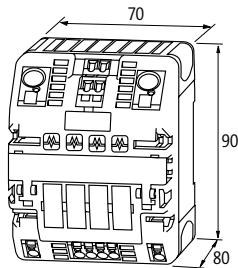

Notes

INTELLIGENT POWER DISTRIBUTION

Over current protection device

- adjustable current ranges
- early warning (90%)

Approvals:   

MICO+ 4.10

4 channels



Order Data	Art-No.
4 A, 6 A, 8 A, 10 A	9000-41084-0401000
Input	
Operating voltage	24 V DC (18...30 V DC)
Output	
Current adjustment	4 A, 6 A, 8 A, 10 A, by countersunk rotary switch, sealed
Inrush capacity	max. 20 mF (per channel)
Control inputs	
Input voltage (ON)	10...30 V DC
Remote start (OFF)	10...30 V DC
Impulse length (ON)	min. 20 ms
Control outputs	
Group alarm output	max. 20 mA; high: all channels ON; low: not all channels ON
Early warning (90%)	max. 20 mA; high: one channel over 90%; low: all channels under 90%
General data	
Connection	Spring clamp terminals
Input terminals	2 × 16 mm ²
Output terminals	per output 2 × 1.5 mm ²
Alarm terminals	2.5 mm ²
Bridging concept	two sides, with spring clamp terminals or bridge set (max. 40 A)
Mounting method	DIN-rail mountable TH35 (EN 60715)
Temperature range	0...+55 °C (storage temperature -40...+80 °C)
Dimension drawing	

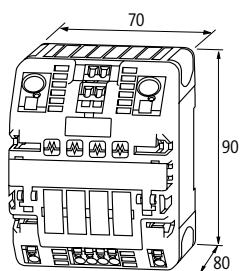

Notes

Intelligent Power Distribution

INTELLIGENT POWER DISTRIBUTION

Over current protection device

MICO 4.4

4 channels



MICO 2.4

2 channels



Approvals:  Class 2  Listed
 US

Order Data	Art-No.	Art-No.
1 A, 2 A, 3 A, 4 A	DNV-GL 9000-41034-0100400	cURus 9000-41042-0100400
Input	Operating voltage 24 V DC (18...30 V DC)	
Output	Current adjustment 1 A, 2 A, 3 A, 4 A, by countersunk rotary switch, sealed	
Control inputs	Inrush capacity max. 20 mF (per channel)	
Control outputs	Input voltage (ON) 10...30 V DC	
	Impulse length (ON) min. 20 ms	
General data	Group alarm output potential free 30 V AC/DC, 100 mA	
Connection	Spring clamp terminals	
Input terminals	2 × 16 mm ²	1 × 16 mm ²
Output terminals	per output 1 × 4 mm ²	
Alarm terminals	2.5 mm ²	
Bridging concept	two sides, with spring clamp terminals or bridge set (max. 40 A)	one side, with spring clamp terminals or bridge set (max. 40 A)
Mounting method	DIN-rail mountable TH35 (EN 60715)	
Temperature range	0...+55 °C (storage temperature -40...+80 °C)	

Dimension drawing

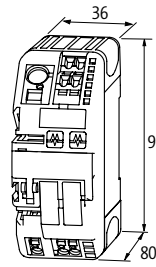
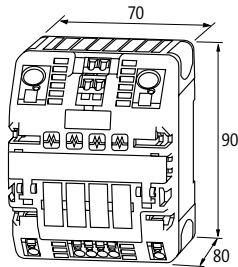

Notes

Intelligent Power Distribution

INTELLIGENT POWER DISTRIBUTION

Over current protection device

MICO 4.6

4 channels



MICO 2.6

2 channels



Approvals:   

Order Data	Art-No.		Art-No.
1 A, 2 A, 4 A, 6 A	DNV-GL	9000-41034-0100600	cURus 9000-41042-0100600
Input			
Operating voltage	24 V DC (18...30 V DC)		
Output			
Current adjustment	1 A, 2 A, 4 A, 6 A, by countersunk rotary switch, sealed		
Inrush capacity	max. 20 mF (per channel)		
Control inputs			
Input voltage (ON)	10...30 V DC		
Impulse length (ON)	min. 20 ms		
Control outputs			
Group alarm output	potential free 30 V AC/DC, 100 mA		
General data			
Connection	Spring clamp terminals		
Input terminals	2 × 16 mm ²	1 × 16 mm ²	
Output terminals	per output 1 × 4 mm ²		
Alarm terminals	2.5 mm ²		
Bridging concept	two sides, with spring clamp terminals or bridge set (max. 40 A)	one side, with spring clamp terminals or bridge set (max. 40 A)	
Mounting method	DIN-rail mountable TH35 (EN 60715)		
Temperature range	0...+55 °C (storage temperature -40...+80 °C)		

Dimension drawing

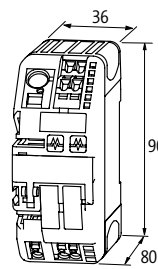
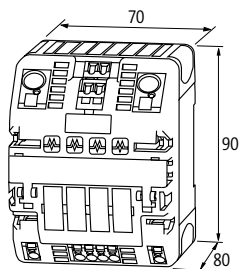

Notes

INTELLIGENT POWER DISTRIBUTION

Over current protection device

MICO 4.10

4 channels



MICO 2.10

2 channels



Approvals:   

Order Data	Art-No.	Art-No.
4 A, 6 A, 8 A, 10 A	DNV-GL 9000-41034-0401000	cURus 9000-41042-0401000
Input		
Operating voltage	24 V DC (18...30 V DC)	
Output		
Current adjustment	4 A, 6 A, 8 A, 10 A, by countersunk rotary switch, sealed	
Inrush capacity	max. 20 mF (per channel)	
Control inputs		
Input voltage (ON)	10...30 V DC	
Impulse length (ON)	min. 20 ms	
Control outputs		
Group alarm output	potential free 30 V AC/DC, 100 mA	
General data		
Connection	Spring clamp terminals	
Input terminals	2 × 16 mm ²	1 × 16 mm ²
Output terminals	per output 1 × 4 mm ²	
Alarm terminals	2.5 mm ²	
Bridging concept	two sides, with spring clamp terminals or bridge set (max. 40 A)	one side, with spring clamp terminals or bridge set (max. 40 A)
Mounting method	DIN-rail mountable TH35 (EN 60715)	
Temperature range	0...+55 °C (storage temperature -40...+80 °C)	

Dimension drawing

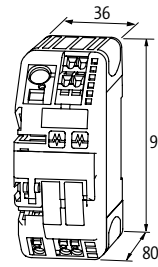
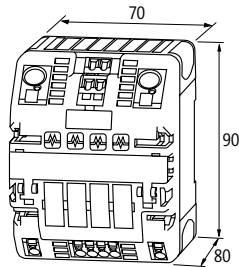

Notes

INTELLIGENT POWER DISTRIBUTION

Over current protection device

MICO 4.4.10 ACTUATOR-SENSOR

MICO 4.10 SPEED START

4 channels
optimized start-up behavior

Approvals:   



Order Data	Art-No.	Art-No.
1 A, 2 A, 3 A, 4 A; 4 A, 6 A, 8 A, 10 A	9000-41034-0101000	
4 A, 6 A, 8 A, 10 A		9000-41034-0401005
Input		
Operating voltage	24 V DC (18...30 V DC)	
Output		
Current adjustment	1 A, 2 A, 3 A, 4 A; 4 A, 6 A, 8 A, 10 A, by countersunk rotary switch, sealed	4 A, 6 A, 8 A, 10 A, by countersunk rotary switch, sealed
Inrush capacity	max. 20 mF (per channel)	max. 30 mF (per channel)
Control inputs		
Input voltage (ON)	10...30 V DC	
Impulse length (ON)	min. 20 ms	
Control outputs		
Group alarm output	potential free 30 V AC/DC, 100 mA	
General data		
Connection	Spring clamp terminals	
Input terminals	2 × 16 mm ²	
Output terminals	per output 1 × 4 mm ²	
Alarm terminals	2.5 mm ²	
Bridging concept	two sides, with spring clamp terminals or bridge set (max. 40 A)	
Mounting method	DIN-rail mountable TH35 (EN 60715)	
Temperature range	0...+55 °C (storage temperature -40...+80 °C)	
Dimension drawing		

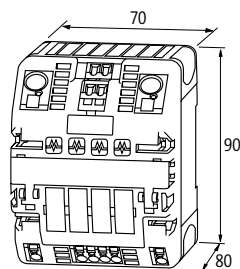

Notes

INTELLIGENT POWER DISTRIBUTION

Over current protection device

– preset current ranges

Approvals:   
Listed C US



MICO BASIC 8.2

8 channels



MICO BASIC 8.4

8 channels

MICO BASIC 8.6

8 channels

Order Data	Art-No.	Art-No.	Art-No.
2 A	NEC Class 2 9000-41068-0200000		
4 A		NEC Class 2 9000-41068-0400000	
6 A			9000-41068-0600000
Input			
Operating voltage	24 V DC (18...30 V DC)		
Output			
Current adjustment	2 A	4 A	6 A
Inrush capacity	max. 20 mF (per channel)		
Control inputs			
Input voltage (ON)	10...30 V DC		
Impulse length (ON)	min. 20 ms		
Control outputs			
Group alarm output	max. 20 mA; high: all channels ON; low: not all channels ON		
General data			
Input terminals	1 × 16 mm ²		
Output terminals	per output 1 × 4 mm ²		
Alarm terminals	2.5 mm ²		
Bridging concept	one side, with spring clamp terminals or bridge set (max. 40 A)		
Connection	Spring clamp terminals		
Mounting method	DIN-rail mountable TH35 (EN 60715)		
Temperature range	0...+55 °C (storage temperature -40...+80 °C)		
Dimension drawing			

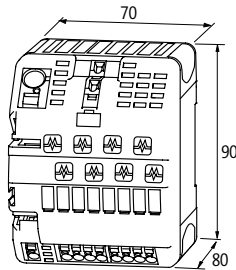

Notes

Intelligent Power Distribution

INTELLIGENT POWER DISTRIBUTION

Over current protection device

– preset current ranges

Approvals:    



MICO BASIC 4.2

4 channels



MICO BASIC 4.4

4 channels

MICO BASIC 4.6

4 channels

Order Data	Art-No.	Art-No.	Art-No.
2 A	NEC Class 2 9000-41064-0200000		
4 A		NEC Class 2 9000-41064-0400000	
6 A			9000-41064-0600000
Input			
Operating voltage	24 V DC (18...30 V DC)		
Output			
Current adjustment	2 A	4 A	6 A
Inrush capacity	max. 20 mF (per channel)		
Control inputs			
Input voltage (ON)	10...30 V DC		
Impulse length (ON)	min. 20 ms		
Control outputs			
Group alarm output	max. 20 mA; high: all channels ON; low: not all channels ON		
General data			
Connection	Spring clamp terminals		
Input terminals	1 × 16 mm ²		
Output terminals	per output 1 × 4 mm ²		
Alarm terminals	2.5 mm ²		
Bridging concept	one side, with spring clamp terminals or bridge set (max. 40 A)		
Mounting method	DIN-rail mountable TH35 (EN 60715)		
Temperature range	0...+55 °C (storage temperature -40...+80 °C)		
Dimension drawing			

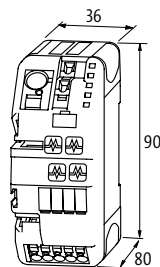

Notes

INTELLIGENT POWER DISTRIBUTION

Over current protection device

– preset current ranges

MICO BASIC 5.2/3.6

8 channels



Approvals:  Class 2   US

Order Data		Art-No.
5 × 2 A; 3 × 6 A		9000-41068-0200600
Input		
Operating voltage	24 V DC (18...30 V DC)	
Output		
Current adjustment	5 × 2 A; 3 × 6 A	
Inrush capacity	max. 20 mF (per channel)	
Control inputs		
Input voltage (ON)	10...30 V DC	
Impulse length (ON)	min. 20 ms	
Control outputs		
Group alarm output	max. 20 mA; high: all channels ON; low: not all channels ON	
General data		
Connection	Spring clamp terminals	
Input terminals	1 × 16 mm ²	
Output terminals	per output 1 × 4 mm ²	
Alarm terminals	2.5 mm ²	
Bridging concept	one side, with spring clamp terminals or bridge set (max. 40 A)	
Mounting method	DIN-rail mountable TH35 (EN 60715)	
Temperature range	0...+55 °C (storage temperature -40...+80 °C)	
Dimension drawing		

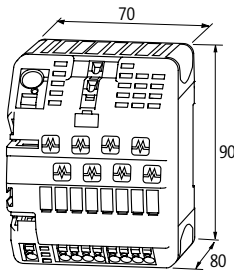

Notes

Intelligent Power Distribution

INTELLIGENT POWER DISTRIBUTION

Socket for glass tube fuses

MICO FUSE 24 LED

8 channels



MICO FUSE 250

8 channels







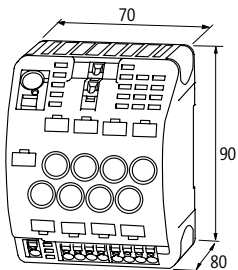

Approvals: **UL** **SP**

Order Data	Art-No.	Art-No.
24 V DC	9000-41078-0600001	
max. 250 V AC/DC		9000-41078-0600002
Technical Data		
Operating voltage	24 V DC (18...30 V DC)	max. 250 V AC/DC
Operating current	max. 6 A (40 °C)	
Total current	max. 40 A	
Control outputs		
Group alarm output	max. 20 mA; high: all channels ON; low: not all channels ON	-
General data		
Connection	Spring clamp terminals	
Input terminals	1 × 16 mm ²	
Output terminals	1 × 0.5...4 mm ²	
Alarm terminals	2.5 mm ²	-
Mounting method	DIN-rail mountable TH35 (EN 60715)	
Temperature range	-25...+55 °C	
Dimension drawing		



Notes

INTELLIGENT POWER DISTRIBUTION

Accessories			Art-No.
	Bridge system	Quantity: 1 piece	9000-41034-0000002
		Quantity: 10 pcs.	9000-41034-0000001
	Shortened buttons	Quantity: 4 pcs.	9000-41034-0000003
	Label plates		
	KES 20 × 8 (white)	(10 pieces/2 plates)	996067
	KMR 5 × 10 (white) MICO BASIC, MICO FUSE, Mico Pro®	(64 pieces/4 plates)	996078
	Glass automotive fuse		
	2 A (T)		9000-41078-0000002
	4 A (T)		9000-41078-0000004
	Fuse cap	Quantity: 8 pcs.	9000-41078-0000010
Accessories Mico Pro®			Art-No.
	Plug-In-Link 2 × blue		
	Length: 500 mm		9000-41000-0000000
	Plug-In-Link 2 × red		
	Length: 500 mm		9000-41000-0000001
	Plug-In-Link 1 × blue, 1 × red		
	Length: 500 mm		9000-41000-0000002
	Cover plate		
	1 Set (left/right)		9000-41000-0000006



CONVERTERS / RECTIFIERS

- Compact design
- Galvanic separation
- Switch mode models

SMALL VOLTAGE CONVERTERS

Voltages in control systems often have to be converted. The DC/DC converters in the MDD series do this perfectly! It doesn't matter if you need 5, 10, 12 or 24 volts – Murrelektronik has the right product.

If there is only AC voltage available, the NG rectifier series can convert into DC voltage. All models can be conveniently mounted in the control cabinet on DIN rail.

AC/DC and DC/DC Converters



MDD, GLS, GSS, NG, NT

- Output current range: 0.5...4A

Page 1.5.1

Rectifiers



NG

- Output current range: 2.6...10A

Page 1.5.3

CONVERTERS / RECTIFIERS

Switched mode

– with galvanic isolation

MDD

OUTPUT: 24 V DC
Current: 0.3 A



MDD

OUTPUT: 12 V DC
Current: 0.7 A



MDD

OUTPUT: 5 V DC
Current: 1.5 A



MDD

OUTPUT: ± 10 V DC
Current: 2×0.25 A

MDD

OUTPUT: ± 15 V DC
Current: 2×0.25 A

Circuit diagram

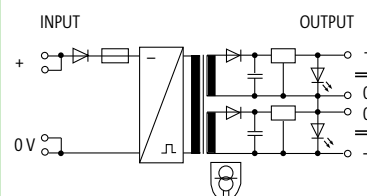
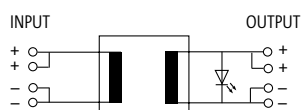

Order Data	Art-No.	Art-No.	Art-No.	Art-No.	Art-No.
24 V DC/0.3 A	85655				
12 V DC/0.7 A		85656			
5 V DC/1.5 A			85657		
± 10 V DC/ 2×250 mA				85658	
± 15 V DC/ 2×250 mA					85659

Input					
Input voltage	24 V DC				
Input current	0.6 A		0.85 A		
Input fuse (external)	2 A (T)				
Input fuse (internal)	1.5 A (T)				
Output					
Output fuse	short-circuit and overload protected, restart after overload by removing power supply				
Output voltage	24 V DC (SELV), $\pm 2\%$	12 V DC (SELV), $\pm 2\%$	5 V DC (SELV), $\pm 2\%$	± 10 V DC (SELV), $\pm 5\%$	± 15 V DC (SELV), $\pm 5\%$
Output current	max. 0.3 A	max. 0.7 A	max. 1.5 A	max. 2×250 mA	
Ripple	max. 0.2 %rms				
General data					
Standards	EN 61204-3				
Test isolation voltage	4 kV (input/output)				
Mounting method	DIN-rail mountable TH35 or G32 (EN 60715)				
Temperature range	0...+50 °C, no condensation				
Dimension drawing					

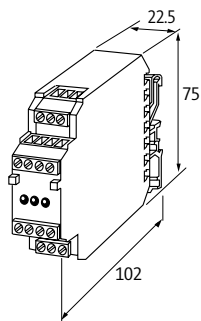

Notes

CONVERTERS / RECTIFIERS

DC/DC converters

AC/DC converters

GLS

OUTPUT regulated: 5 V DC
Current: 1.2 A



GSS

OUTPUT switched mode: 5 V DC
Current: 4 A



NT

OUTPUT: 5...35 V DC
Current: 3.5 A



Circuit diagram

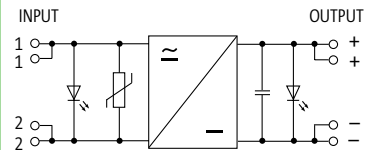
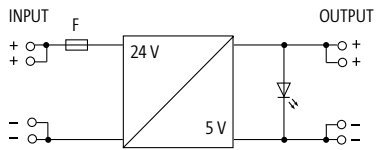

Order Data	Art-No.	Art-No.	Art-No.
5 V DC/1.2 A	85600		
5 V DC/4 A		85650	
5...35 V DC/3.5 A			85660
Input			
Input voltage	24 V DC (+10 -15%)	15...40 V DC	10...32 V AC/12...42 V DC
Input current	1.2 A	1.04 A (24 V DC); max. 1.7 A	max. 3 A
Input fuse (internal)	2 A (T)		6.3 A (T)
Frequency	-		50...60 Hz
Output			
Output voltage	5 V DC (SELV), ±5%		5...35 V DC (SELV), Uout-max. = Uin - 5 V
Output current	max. 1.2 A	max. 4 A	max. 3.5 A
Ripple	max. 0.2 %rms		max. 300 mVrms
Output fuse	short-circuit protected		
General data			
Mounting method	DIN-rail mountable TH35 (EN 60715)		
Temperature range	-20...+60 °C, no condensation		
Dimension drawing			

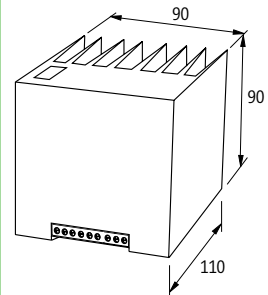
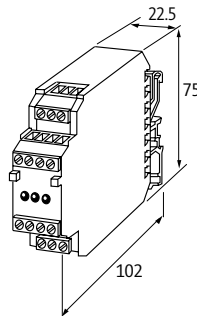
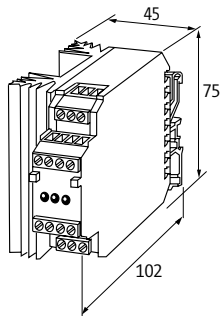

Notes

CONVERTERS / RECTIFIERS

Rectifier modules

– Single-phase

– IP00

NG 2

INPUT: max. 41 V AC



NG 5

INPUT: max. 41 V AC

NG 10

INPUT: 29 V AC



Circuit diagram

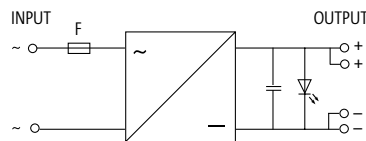

Order Data	H×W×D	Art-No.	H×W×D	Art-No.	H×W×D	Art-No.
24 V DC/2.6 A	86×45×92 mm	85700				
24 V DC/5 A			90×68×87 mm	85710		
24 V DC/10 A						85730
Input						
Input voltage	max. 5...44 V AC			29 V AC		
Input current	max. 2.6 A; 1.8 A (+60 °C)		max. 5 A; 4 A (+60 °C)		max. 10 A	
Frequency	45...65 Hz			50...60 Hz (or as additional smoothing for DC)		
Input fuse (external)	–		8 A (T), 5 × 20 mm		16 A (T), 5 × 20 mm	
Input fuse (internal)	3.15 A (T), 5 × 20 mm		–			
Output						
Output voltage	U-IN × 1.16/max. 60 V DC			U-IN × 1.16/39 V DC		
Output current	max. 2.6 A; 1.8 A (+60 °C)		max. 5 A; 4 A (+60 °C)		max. 10 A	
Ripple	max. 5 %rms					
Output filter	smoothed with smoothing capacitor and LED					
General data						
Mounting method	DIN-rail mountable TH35 (EN 60715)					
Temperature range	-20...+60 °C					
Dimension drawing						

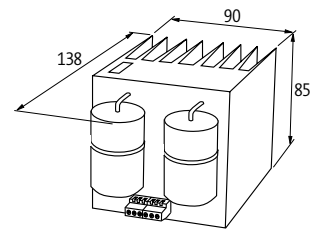
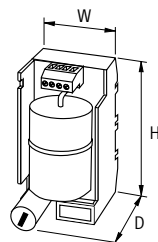

Notes



MODLINK MSVD – CONTROL CABINET POWER OUTLETS

- Safe
- Easy to install
- Meet international standards

KEEP IT SAFE – EVEN IN THE CONTROL CABINETS

Using components temporarily in the control cabinet require right power outlets. Murrelektronik has the right tools: a wide range of power outlets for different countries.

Control Cabinet Power Outlets



German standard (VDE)

- For DIN-rail mounting acc. to EN 60715
- With screw terminals or spring clamp terminals

An overview of this product range can be found in our online shop



French standard (UTE)

- For DIN-rail mounting acc. to EN 60715
- With screw terminals or spring clamp terminals

An overview of this product range can be found in our online shop



American standard (NEMA 5-15)

- For DIN-rail mounting acc. to EN 60715
- With screw terminals
- LED display

An overview of this product range can be found in our online shop



Different international standards

- For DIN-rail mounting acc. to EN 60715

An overview of this product range can be found in our online shop



EMC FILTERS FOR MAXIMUM SAFETY

- Meets EMC guidelines
- Increases interference protection
- Decreases interference emissions

KEEP IT SAFE – EVEN IN THE CONTROL CABINETS

Mains filters are used to reduce interference without affecting the supply. Murrelektronik's filters decrease incoming interference, which can affect sensitive equipment, and also decrease outgoing interference from the equipment they are connected to, which could damage the mains supply. Typical sources of continuous interference are switch mode power supplies, motors and phase controllers.

These sources are made up of inductive and capacitive components and work the best when their impedance is matched to the source of the interference. In regards to grounding, it's important to have a low impedance. Ideally, the filter should be as close as possible to the point where the cable enters the cabinet. If that's not possible, then shielded cables should be used between the filter and the entry point. Ground straps should be as short as possible and connection surfaces should be free from paint, etc.

Single-phase



MEF Emparro® 1/1 – one-stage

- Operating voltage: max. 265 V AC/DC
- Nominal current: 20 A

Page 1.7.1



MEF 1/2 SY and MEF 1/2 AS – two-stage

- Operating voltage: max. 250 V AC/DC, 0...60 Hz
- Nominal current: 10...16 A

Page 1.7.2

Three-phase



MEF 3/1 N – one-stage

- Operating voltage: max. 3 × 440 V AC
- Nominal current: 3...20 A

Page 1.7.5



MEF 3/1 N HD – one-stage

- Operating voltage: max. 3 × 500 V AC
- Nominal current: 10...135 A

Page 1.7.6



MEF 3/1 and MEF 3/2 – one and two-stage

- Operating voltage: max. 3 × 500 V AC / 3 × 600 V AC
- Nominal current: 8...180 A

Page 1.7.7

EMC FILTERS

1-phase, 1-stage

- DIN-rail mountable

MEF Emparro® 1/1
wide attenuation spectrum



Approvals: **ULus**

Circuit diagram

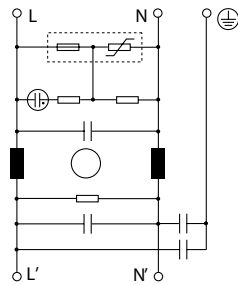

Order Data

20 A Art-No. 10701

Technical Data

Operating voltage	85...265 V AC/100...230 V DC
Operating frequency	50...60 Hz
Consumption	max. 1 mA (250 V AC)
Connection cross section	1.5...10 mm ² single core (AWG 16...8); 1.5...6 mm ² multiple core (AWG 16...10)

General data

Climatic category	Environment class (EN 60721)
Connection	Push In terminals
Mounting method	DIN-rail mountable TH35 (EN 60715)

Dimension drawing

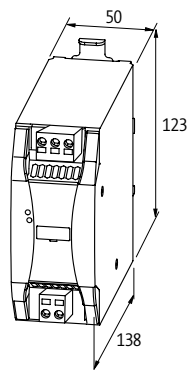

Notes

EMC FILTERS

1-phase, 1-stage

– DIN-rail mountable

Approvals: 

MEF 1/1

for universal applications



Circuit diagram

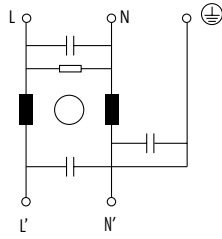

Order Data	Art-No.
10 A	10415
20 A	10416

Technical Data	
Operating voltage	max. 250 V AC/300 V DC
Operating frequency	50...60 Hz
Consumption	max. 5 mA (250 V AC)
Overload current	18 × (IN t) max. 0.5 ms; 1.5 × (IN t) max. 1 min. (1 × per hour)
Connection cross section	0.2...6 mm ² single core (AWG 24...9); 0.2...4 mm ² multiple core (AWG 24...11)

General data	
Climatic category	25/085/21 (EN 60068-1)
Test isolation voltage	2.7 kV (L - N), 2 s; 2.1 kV (L - L), 2 s (EN 60939-2)
Connection	Screw connection, touch protected
Mounting method	DIN-rail mountable TH35 (EN 60715)

Dimension drawing

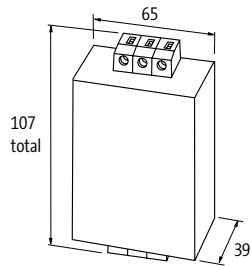

Notes

EMC FILTERS

1-phase, 2-stage

– DIN-rail mountable

Approvals: 

MEF 1/2 SY

against symmetrical interferences



Circuit diagram

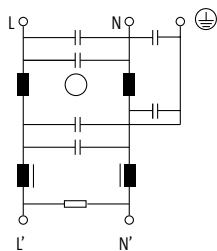

Order Data

	Art-No.
1 A	10460
2 A	10461
3 A	10462
4 A	10463
6 A	10464
16 A	10466

Technical Data

Operating voltage	max. 250 V AC/300 V DC
Operating frequency	50...60 Hz
Overload current	18 × (IN t) max. 0.5 ms; 1.5 × (IN t) max. 1 min. (1 × per hour)
Consumption	max. 5 mA (250 V AC)
Connection cross section	0.2...6 mm ² single core (AWG 24...9); 0.2...4 mm ² multiple core (AWG 24...11)

General data

Climatic category	25/085/21 (EN 60068-1)
Test isolation voltage	2.7 kV (L - N), 2 s; 2.1 kV (L - L), 2 s (EN 60939-2)
Connection	Screw connection, touch protected
Mounting method	DIN-rail mountable TH35 (EN 60715)

Description

Functional description
The single phase 2-stage EMC filters MEF 1/2 are used in the range 0.1...30 MHz to suppress cable carried interference on mains and control cables. The best filter performance is achieved by using short connection wires (suggestion: earth connection < 10 cm) and the largest possible diameter. The EMC filters work bi-directionally (in both directions). The filters are for demanding applications. The filters are designed for use with fixed modules. One step of the filter is always for the suppression of asymmetrical interferences (magnetically compensated suppression). The second step is, dependant on application for symmetrical or asymmetrical interferences.

Application
symmetrical interferences: units with high repetitions of the switching processes, - switch mode P.S.U.s, - phase angle controller, - supply of universal motors, - behind transformers

Dimension drawing

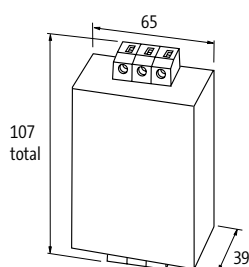



Notes

EMC FILTERS

1-phase, 2-stage

- DIN-rail mountable

Approvals:  

MEF 1/2 AS

against asymmetrical interferences



Circuit diagram

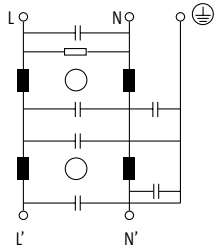

Order Data	Art-No.
3 A	10470
6 A	10471
10 A	10472

Technical Data	
Operating voltage	max. 250 V AC/300 V DC
Operating frequency	50...60 Hz
Consumption	max. 5 mA (250 V AC)
Overload current	18 × (IN t) max. 0.5 ms; 1.5 × (IN t) max. 1 min. (1 × per hour)
Connection cross section	0.2...6 mm ² single core (AWG 24...9); 0.2...4 mm ² multiple core (AWG 24...11)

General data	
Climatic category	25/085/21 (EN 60068-1)
Test isolation voltage	2.7 kV (L - N), 2 s; 2.1 kV (L - L), 2 s (EN 60939-2)
Connection	Screw connection, touch protected
Mounting method	DIN-rail mountable TH35 (EN 60715)

Description	
Functional description	The single phase 2-stage EMC filters MEF 1/2 are used in the range 0.1...30 MHz to suppress cable carried interference on mains and control cables. The best filter performance is achieved by using short connection wires (suggestion: earth connection < 10 cm) and the largest possible diameter. The EMC filters work bi-directionally (in both directions). The filters are for demanding applications. The filters are designed for use with fixed modules. One step of the filter is always for the suppression of asymmetrical interferences (magnetically compensated suppression). The second step is, dependant on application for symmetrical or asymmetrical interferences.

Application	asymmetrical interferences: - units with high switching frequency and repetition, - switch mode P.S.U.s, - in DC mains, - in front of transformers, - for frequency inverters
-------------	---

Dimension drawing

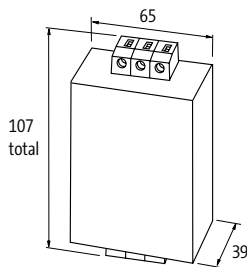

Notes

EMC FILTERS

3-phase, 1-stage

– DIN-rail mountable

– with neutral

Approvals: 

MEF 3/1 N

for universal applications



Circuit diagram

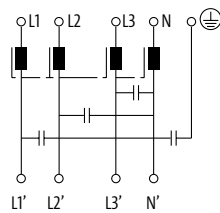

Order Data

	Art-No.
3 A	10510
6 A	10511
10 A	10512
20 A	10513

Technical Data

Operating voltage	max. 4 × 440 V AC
Operating frequency	50...60 Hz
Consumption	max. 3 mA (250 V AC)
Overload current	18 × (IN t) max. 0.5 ms; 1.5 × (IN t) max. 1 min. (1 × per hour)
Connection cross section	0.2...6 mm ² single core (AWG 24...9); 0.2...4 mm ² multiple core (AWG 24...11)

General data

Climatic category	25/085/21 (EN 60068-1)
Test isolation voltage	2.7 kV (L - N), 2 s; 2.1 kV (L - L), 2 s (EN 60939-2)
Connection	Screw connection, touch protected
Mounting method	DIN-rail mountable TH35 (EN 60715)

Description

Functional description
The 3-phase and one-stage EMC filters MEF 3/1 are used in the range 0.1...30 MHz and dampen interferences found in cables from the mains, supply units and control systems. They are suitable for TN-S, TN-CS, and TT networks. The best results are obtained with short connection cables (suggestion: earth connection < 10 cm) of the largest possible cross-section. The EMC filters are bi-directional. They reduce symmetrical and asymmetrical interferences that regularly appear with electronically controlled three phase units through mains influences.

Dimension drawing

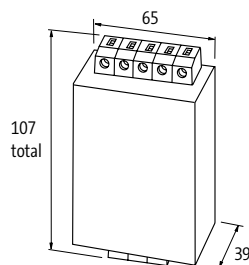

Notes

EMC FILTERS

3-phase, 1-stage

– with neutral

Approvals: 

MEF 3/1 N HD

with increased damping



Circuit diagram

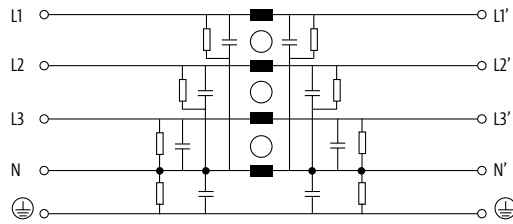

Order Data	H×W×D/kg	Art-No.
10 A	153×130×100/1.0	10571
18 A	153×130×100/1.0	10572
36 A	153×130×100/1.1	10574
72 A	153×118×125/1.6	10575
100 A	170×180×140/3.4	10577
135 A	170×180×140/4.5	10578

Technical Data

Connection cross section	0.2...10 mm ² single core (AWG 24...7); 0.2...6 mm ² multiple core (AWG 24...9)
Operating voltage	max. 3 × 500 V AC
Operating frequency	50...60 Hz
Consumption	max. 15 mA (250 V AC)
Overload current	18 × (I _N t) max. 0.5 ms; 1.5 × (I _N t) max. 1 min. (1 × per hour)

General data

Mounting method	screw fixing, M6
Climatic category	25/085/21 (EN 60068-1)
Test isolation voltage	3.3 kV (L - N), 2 s; 3.1 kV (L - L), 2 s

Description

Functional description
The 3-phase and one-stage EMC filters MEF 3/1 are used in the range 0.1...30 MHz and dampen interferences found in cables from the mains, supply units and control systems. They are suitable for TN-S, TN-CS, and TT networks. The best results are obtained with short connection cables (suggestion: earth connection < 10 cm) of the largest possible cross-section. The EMC filters are bi-directional. They reduce symmetrical and asymmetrical interferences that regularly appear with electronically controlled three phase units through mains influences.

Dimension drawing

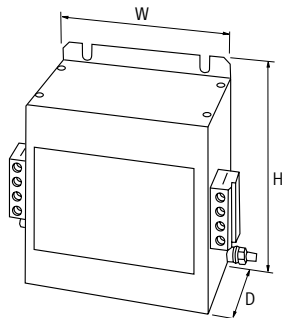

Notes

EMC FILTERS

3-phase, 1-stage

– Space saving book form

MEF 3/1



Approvals: 

Circuit diagram

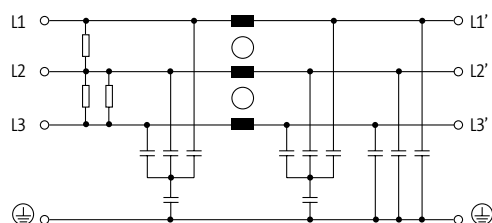

Order Data	H×W×D/kg	Art-No.
8 A	250×90×100/1.3	10531
16 A	250×90×100/1.3	10532
25 A	250×90×100/1.3	10533
36 A	250×90×100/1.5	10534
50 A	250×90×100/1.7	10535
80 A	270×85×135/2.2	10537
110 A	270×90×150/3.2	10538
180 A	380×120×170/5.1	10539

Technical Data

Operating voltage	max. 3 × 600 V AC
Operating frequency	50...60 Hz
Overload current	18 × (IN t) max. 0.5 ms; 1.5 × (IN t) max. 1 min. (1 × per hour)
Consumption	max. 10 mA (250 V AC)
Connection cross section	0.2...10 mm ² single core (AWG 24...7); 0.2...6 mm ² multiple core (AWG 24...9)

General data

Climatic category	25/085/21 (EN 60068-1)
Test isolation voltage	3.3 kV (L - N), 2 s; 3.1 kV (L - L), 2 s
Connection	Screw connection, touch protected
Mounting method	screw fixing

Description

Functional description
 The 3-phase and 1-/2-stage EMC filters MEF 3/1-3/2 are used in the range 0.1...30 MHz and dampen interferences found in cables from the mains, supply units and control systems. They are suitable for TN-C-mains. The best results are obtained with short connection cables (suggestion: earth connection < 10 cm) of the largest possible cross-section. The EMC filters are bi-directional. They reduce symmetrical and asymmetrical interferences that often occur with frequency converters and switch mode power supplies.

Dimension drawing

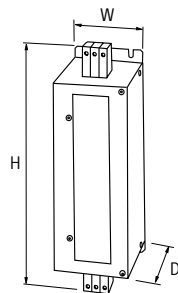

Notes

EMC FILTERS

3-phase, 2-stage

– Space saving book form

Approvals: 

MEF 3/2



Circuit diagram

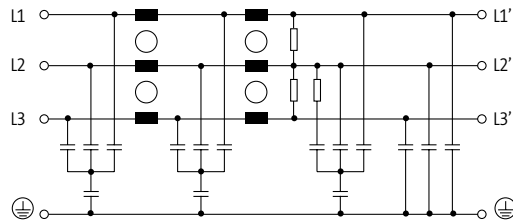

Order Data	HxWxD/kg	Art-No.
8 A	226x50x140/1.7	10550
12 A	226x50x140/1.7	10551
16 A	226x50x140/1.7	10552
25 A	226x50x140/1.7	10553
36 A	226x50x140/1.7	10554
50 A	295x70x177/3.7	10555
80 A	295x70x177/5.1	10556

Technical Data

Operating voltage	max. 3 × 500 V AC
Operating frequency	50..60 Hz
Overload current	18 × (IN t) max. 0.5 ms; 1.5 × (IN t) max. 1 min. (1 × per hour)
Consumption	max. 15 mA (250 V AC)
Connection cross section	0.2...10 mm ² single core (AWG 24...7); 0.2...6 mm ² multiple core (AWG 24...9)

General data

Climatic category	25/085/21 (EN 60068-1)
Test isolation voltage	3.3 kV (L - N), 2 s; 3.1 kV (L - L), 2 s
Connection	Screw connection, touch protected
Mounting method	screw fixing

Description

Functional description
The 3-phase and 1-1/2-stage EMC filters MEF 3/1-3/2 are used in the range 0.1...30 MHz and dampen interferences found in cables from the mains, supply units and control systems. They are suitable for TN-C-mains. The best results are obtained with short connection cables (suggestion: earth connection < 10 cm) of the largest possible cross-section. The EMC filters are bi-directional. They reduce symmetrical and asymmetrical interferences that often occur with frequency converters and switch mode power supplies.

Dimension drawing

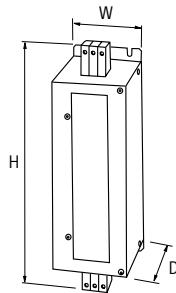

Notes

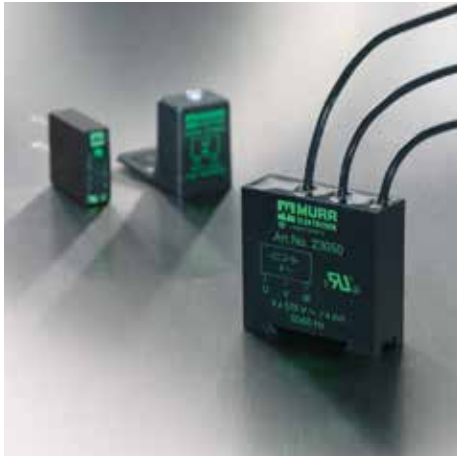

EMC SUPPRESSORS

SMALL DEVICE, BIG IMPACT

- Meets EMC guidelines
- Reduces voltage peaks
- Prevents coil short circuits

MURRELEKTRONIK SOLVES YOUR INTERFERENCE PROBLEMS

- Optimum interference results by adjusting your inductive load
- Prefabricated modules make it easy to install – reliably mounted every time
- Prevents operative failures and outages and increases availability
- Long service life of contacts and switching elements lower maintenance costs

THE RIGHT SUPPRESSION FOR ALL STANDARD INDUCTIVE LOADS

For Contactors

- Integrated system solutions for all standard contactors
- Universal suppressors for contactors or relays that snap in or stick to the mounting surface

For Motors

- Suppression directly next to the interference source or inside the motor terminal box
- Motor connector has 10 poles and an earth connection point with integrated suppressor module and pre-wired cable
- Integrated system solutions for direct connection to the contactor
- Universal suppressors snap in next to the motor contactor

For Valves

- Suppressors are simply mounted between valve base and valve plug instead of the flat gasket

EMC Suppressors

 <p>For Contactors ABB, General Electric, Eaton, Omron, Rockwell A. B., Schneider-Telemecanique, Siemens</p> <p>Universal Suppressors</p> <p style="text-align: right;"><i>Page 1.8.1</i></p>	 <p>For Motors – Installation on the Motor RC 3 U, RC 3 R, RC 3 ST</p> <p style="text-align: right;"><i>Page 1.8.12</i></p>
 <p>For Motors – Installation in the Cabinet RC 3 BUR, HRC 3 AS, RC 3 RT</p> <p style="text-align: right;"><i>Page 1.8.15</i></p>	 <p>For Valves Form A, B, BI, C, CI</p> <p style="text-align: right;"><i>Page 1.8.17</i></p>

EMC SUPPRESSORS

Suppressors for contactors



BC



A 16



A 110

Approvals:

Circuit diagram

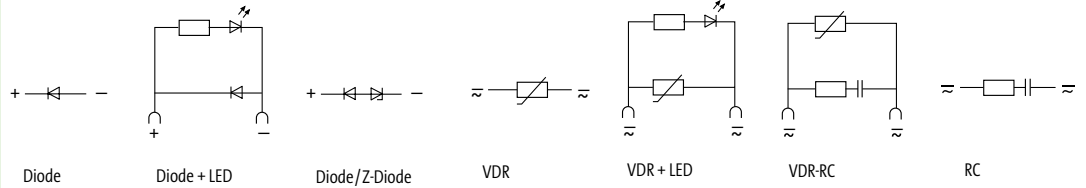

Appropriate contactors

B 6, BC 6, VB 6, KC 6

A 9...A 16

A 26...A 110

Order Data

Order Data		Art.-No.		Art.-No.		Art.-No.	
Voltage	Suppression	Approval		Approval		Approval	
24...240 V DC	Diode				26440		
24 V DC	Diode + LED						
	Diode/Z-Diode						
24 V AC/DC	VDR	CSA	26277				
	VDR + LED						
	RC						
48 V DC	Diode/Z-Diode						
48 V AC/DC	VDR	CSA	26278				
	RC						
110 V AC/DC	VDR						
	VDR + LED						
	VDR-RC						
	RC			CSA	21172	CSA	21173
230 V AC/DC	VDR	CSA	26079				
	VDR + LED						
	VDR-RC						
	VDR-RC + LED						
	RC			CSA	21172	CSA	21173
400 V AC/DC	VDR						
	RC						
415 V AC/DC	RC						

Technical Data

Damping factor	$\sim 1.5 \times U_N$
Temperature range	-20...+70 °C
Material	plastic, flame retardant (UL 94)
Connection wires	self-securing cable forks

Dimension drawing

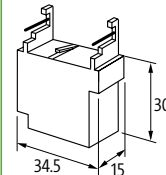
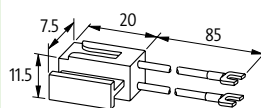

Notes

EMC SUPPRESSORS

Suppressors for contactors



Approvals:

M

CL



Circuit diagram

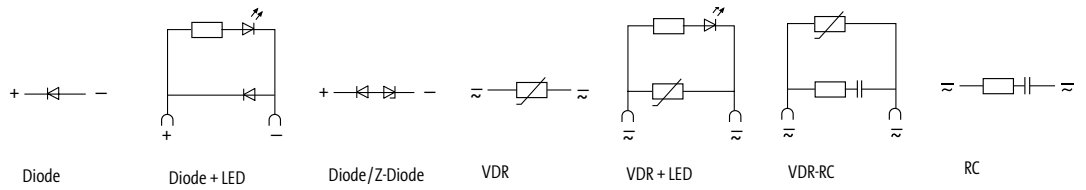

Appropriate contactors

M

CL00, 01, 02, 25

CL03, 04, 45

CL05...10

Order Data		Art.-No.	Art.-No.	Art.-No.	Art.-No.
Voltage	Suppression				
24...240 V DC	Diode	2000-68300-1100000	2000-69100-1100000	2000-69200-1100000	
24 V DC	Diode + LED				
	Diode/Z-Diode				
24 V AC/DC	VDR	2000-68300-4400000	2000-69100-4400000	2000-69200-4400000	2000-69100-4400000
	VDR + LED				
	RC	2000-68300-4300000	2000-69100-4300000	2000-69200-4300000	2000-69101-4300000
48 V DC	Diode/Z-Diode				
48 V AC/DC	VDR	2000-68300-4400000	2000-69100-4400000	2000-69200-4400000	2000-69100-4400000
	RC	2000-68300-4300000	2000-69100-4300000	2000-69200-4300000	2000-69101-4300000
110 V AC/DC	VDR		2000-69100-7400000	2000-69200-7400000	2000-69100-7400000
	VDR + LED				
	VDR-RC				
	RC		2000-69100-7300000		
230 V AC/DC	VDR		2000-69100-2420000	2000-69200-2420000	
	VDR + LED				
	VDR-RC				
	VDR-RC + LED				
	RC			2000-69200-2320000	2000-69101-2320000
400 V AC/DC	VDR		2000-69100-5420000	2000-69200-5420000	2000-69100-5420000
	RC				
415 V AC/DC	RC				

Technical Data

Damping factor	$\sim 1.5 \times U_N$
Temperature range	-20...+70 °C
Material	plastic, flame retardant (UL 94)
Connection wires	plug contact

Dimension drawing

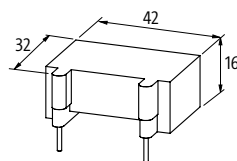
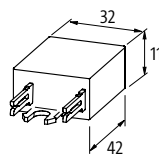

Notes

Art.-No. 2000-69200-1100000 – also for CL05...10 DC-coils.

Suppressors for contactors

X-Start



Approvals:



Circuit diagram

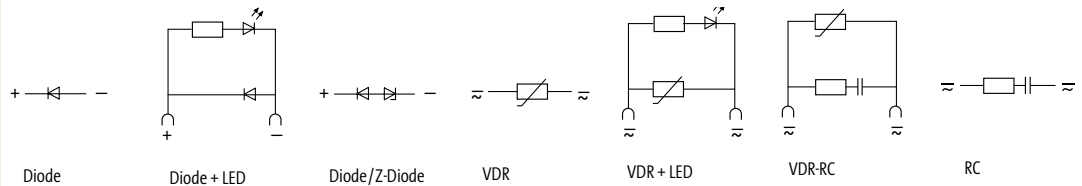

Appropriate contactors

DIL M7...15 DIL MP20, DIL A	DIL M17...32	DIL M40...95
--------------------------------	--------------	--------------

Order Data

Voltage	Suppression	Art.-No.	Art.-No.	Art.-No.
24...240 V DC	Diode			
24 V DC	Diode + LED			
	Diode/Z-Diode			
24 V AC/DC	VDR			
	VDR + LED	26013	26015	
	RC			
48 V DC	Diode/Z-Diode			
48 V AC	VDR + LED	26013	26015	
	RC			
110 V AC/DC	VDR			
	VDR + LED	26014		
	VDR-RC			
	RC	20007	20008	20009
230 V AC/DC	VDR			
	VDR + LED	26014		
	VDR-RC			
	VDR-RC + LED			
	RC	20007	20008	20009
400 V AC/DC	VDR			
	RC			

Technical Data

Damping factor	$\sim 1.5 \times U_N$
Temperature range	-20...+70 °C
Material	plastic, flame retardant (UL 94)
Connection wires	plug contact

Dimension drawing

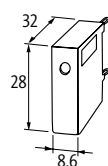

Notes

LED indicator for 24 V DC without suppression available on request.

EMC SUPPRESSORS

Suppressors for contactors



Approvals:

DIL E



Circuit diagram

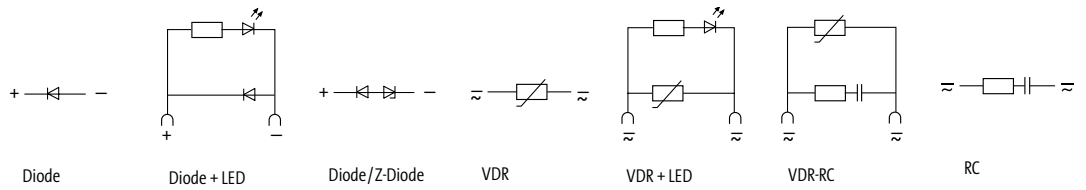

Appropriate contactors

DIL E...

Order Data

Art.-No.

Voltage	Suppression	Art.-No.
24...240 V DC	Diode	
24 V DC	Diode + LED	
	Diode/Z-Diode	
24 V AC/DC	VDR	
	VDR + LED	
	RC	
48 V DC	Diode/Z-Diode	
48 V AC/DC	VDR	
	RC	
110 V AC/DC	VDR	
	VDR + LED	
	VDR-RC	
	RC	21054
230 V AC/DC	VDR	26086
	VDR + LED	
	VDR-RC	
	VDR-RC + LED	
	RC	21054
400 V AC/DC	VDR	
	RC	

Technical Data

Damping factor	$\sim 1.5 \times U_N$
Temperature range	-20...+70 °C
Material	plastic, flame retardant (UL 94)
Connection wires	self-securing cable forks

Dimension drawing

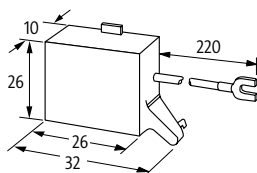

Notes

EMC SUPPRESSORS

Suppressors for contactors

OMRON

J7KNA



J7KN



J7KN



Circuit diagram

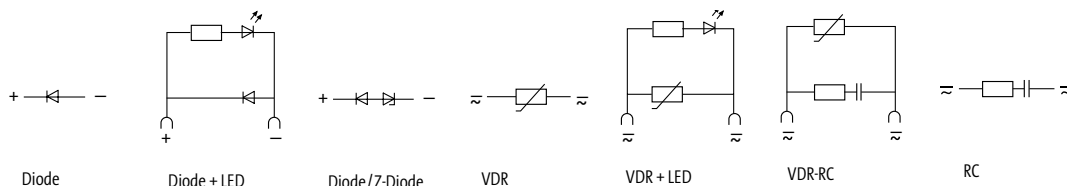

Appropriate contactors

J7KNA

J7KN

J7KN

Order Data

Art.-No.

Art.-No.

Art.-No.

Voltage	Suppression	Art.-No.	Art.-No.	Art.-No.
24...240 V DC	Diode			Approval
24 V DC	Diode + LED			
	Diode/Z-Diode			
24 V AC/DC	VDR			cURus / CSA
	VDR + LED			
	RC	2000-68800-2300000	2000-69000-2300000	26400
48 V DC	Diode/Z-Diode			
48 V AC	VDR			cURus / CSA
	RC			26401
110 V AC/DC	VDR			
	VDR + LED			
	VDR-RC			
	RC	2000-68800-7300000		
230 V AC/DC	VDR			cURus / CSA
	VDR + LED			
	VDR-RC			
	VDR-RC + LED			
	RC	2000-68800-2320000		
400 V AC/DC	VDR			cURus / CSA
	RC			26404

Technical Data

Damping factor	$\sim 1.5 \times U_N$
Temperature range	-20...+70 °C
Material	plastic, flame retardant (UL 94)
Connection wires	self-securing cable forks

Dimension drawing

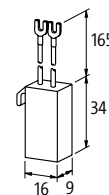
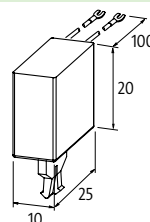
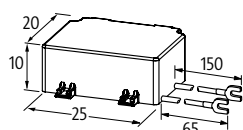

Notes

Further types on request.

EMC SUPPRESSORS

Suppressors for contactors



Approvals:

I00-C



Circuit diagram

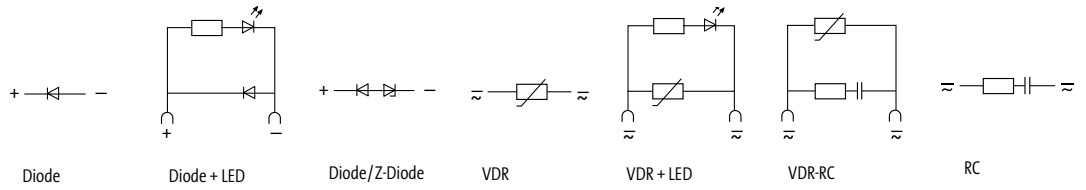

Appropriate contactors

I00-C09...C85

Order Data

Art.-No.

Voltage	Suppression	Art.-No.
24...240 V DC	Diode	2000-68200-1100000
24 V DC	Diode + LED	
24 V AC/DC	Diode /Z-Diode	
	RC	2000-68200-4300000
	VDR	2000-68200-4400000
48 V AC/DC	RC	2000-68200-4300000
	VDR	2000-68200-4400000
110 V AC/DC	VDR	2000-68200-7400000
	VDR + LED	
	VDR-RC	
	RC	2000-68200-1320000
	VDR	2000-68200-2420000
230 V AC/DC	VDR + LED	
	VDR-RC	
	VDR-RC + LED	
	RC	2000-68200-1320000
	VDR	2000-68200-5320000
400 V AC/DC	RC	2000-68200-5320000
	VDR	2000-68200-5420000

Technical Data

Damping factor	$\sim 1.5 \times U_N$
Temperature range	-20...+70 °C
Material	plastic, flame retardant (UL 94)
Connection wires	plug contact

Dimension drawing

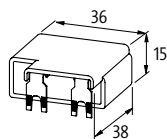

Notes

EMC SUPPRESSORS

Suppressors for contactors



TeSys



TeSys



TeSys



D

Circuit diagram

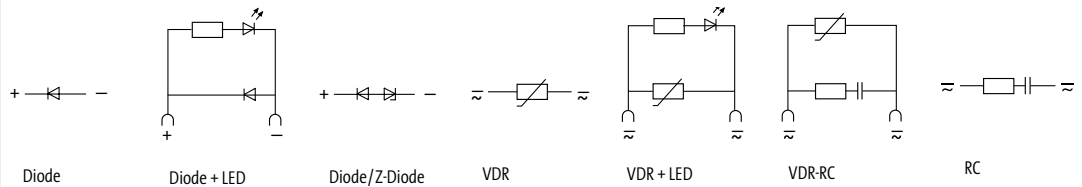

Appropriate contactors

LC 1 D09...D38 LC 1 DT20, DT40, LC 2 D09...D38 AC-coil	LC 1 D09...D38 LC 1 DT20, DT40, LC 2 D09...D38 DC-coil	CA 2 DN, CA 3 DN serie „d“ LC 1 DT20, DT40, LC 2 D09...D38
--	--	---

Order Data	Art.-No.	Art.-No.	Art.-No.	Art.-No.
Voltage	Suppression	Approval	Approval	
24...240 V DC	Diode		cURus 2000-69300-1100000	26481
24 V DC	Z-Diode	26476	cURus 2000-69300-5200000	
24 V AC/DC	VDR	cURus 2000-69400-4400000	cURus 2000-69300-4400000	
	RC	cURus 2000-69400-4300000	cURus 2000-69300-4300000	21070
30...250 V DC	Z-Diode			
48 V AC/DC	VDR	cURus 2000-69400-4400000	cURus 2000-69300-4400000	
	VDR + LED			
	RC	cURus 2000-69400-4300000	cURus 2000-69300-4300000	21070
110 V AC/DC	VDR	cURus 2000-69400-7400000	cURus 2000-69300-7400000	
	VDR + LED			
	RC	21063 cURus 2000-69400-7300000	cURus 2000-69300-7300000	21071
230 V AC/DC	VDR	cURus 2000-69400-2420000	cURus 2000-69300-2420000	
	VDR + LED			
	VDR-RC + LED			
	RC	21063 cURus 2000-69400-2320000	cURus 2000-69300-2320000	21060
	RC + LED			
400 V AC/DC	VDR	cURus 2000-69400-5420000		
	RC	cURus 2000-69400-5320000		

Technical Data

Damping factor	$\sim 1.5 \times U_N$
Temperature range	-20...+70 °C
Material	plastic, flame retardant (UL 94)
Connection wires	plug contact self-securing cable forks self-securing cable forks plug contact

Dimension drawing

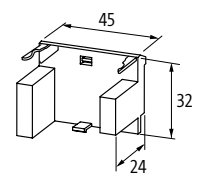
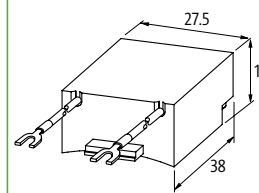
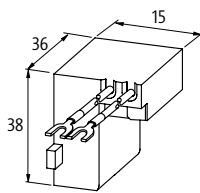
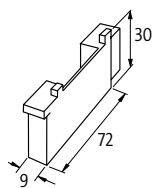

Notes

EMC SUPPRESSORS

Suppressors for contactors

S00

S0

SIEMENS



Circuit diagram

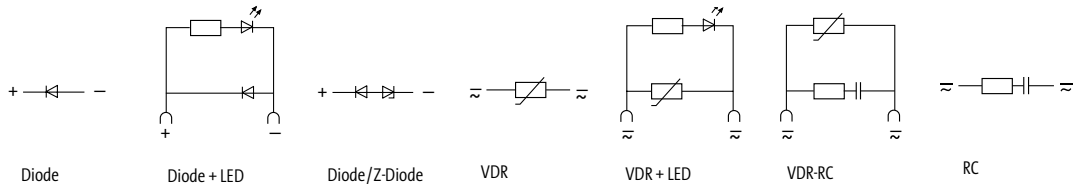

Appropriate contactors

3 RT 20.15/16/17/18

3 RT 20.25/26/27/28

Order Data

Voltage	Suppression	Art.-No.	Art.-No.
24...240 V DC	Diode	2000-68500-1100000	
24 V DC	Diode + LED		2000-68400-2010000
	Diode/Z-Diode		
24 V AC/DC	VDR	2000-68500-4400000	2000-68400-4400000
	VDR + LED	2000-68500-4410000	2000-68400-4410000
	RC	2000-68500-4300000	2000-68400-4300000
48 V AC/DC	VDR		
	RC	2000-68500-4300000	2000-68400-4300000
110 V AC/DC	VDR	2000-68500-7400000	2000-68400-7400000
	VDR + LED	2000-68500-7410000	2000-68400-7410000
	VDR-RC		
	RC	2000-68500-7300000	2000-68400-7300000
230 V AC/DC	VDR	2000-68500-2420000	2000-68400-2420000
	VDR + LED	2000-68500-2470000	
	RC	2000-68500-2320000	2000-68400-2320000
400 V AC/DC	VDR	2000-68500-5420000	2000-68400-5420000
	RC	2000-68500-5320000	2000-68400-5320000

Technical Data

Damping factor	$\sim 1.5 \times U_N$
Temperature range	-20...+70 °C
Material	plastic, flame retardant (UL 94)
Connection wires	plug contact

Dimension drawing

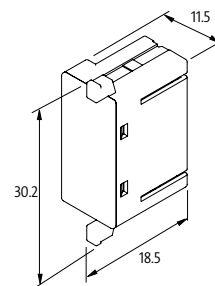
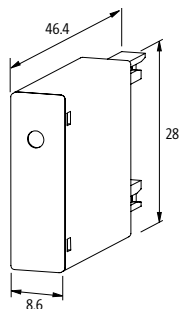

Notes

Suppressors for contactors

SIEMENS

S0 4



S0 1



3 TF/L-3 TF



Circuit diagram

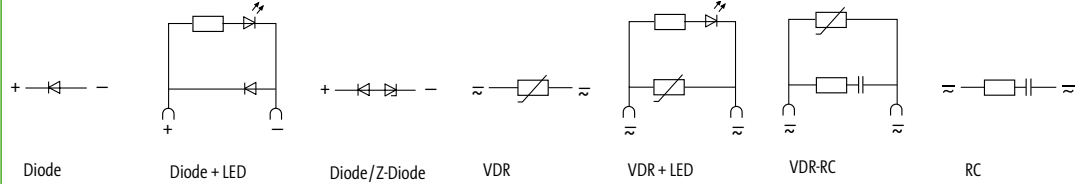

Appropriate contactors

3 TF 30...35
3 TF 40...45

3 TF 30...45
3 TB 40...3 TB 44

3 TH 2, 3 TF 2
3 TH 20, 3 TF 20

Order Data

Order Data		Art.-No.	Art.-No.	Art.-No.
Voltage	Suppression	Approval	Approval	Approval
24...240 V DC	Diode	CSA	UR / CSA	cURus / CSA
24 V DC	Diode + LED	26588	26283	26036
	Diode/Z-Diode		UR / CSA	cURus / CSA
			26051	26034
24 V AC/DC	VDR	CSA		
	VDR + LED			
	RC		UR / CSA	
			22050	
48 V DC	Diode/Z-Diode			
48 V AC/DC	VDR	CSA		cURus / CSA
	RC		UR / CSA	
			22051	26038
110 V AC/DC	VDR			
	VDR + LED			
	VDR-RC			
	RC		UR / CSA	
			22051	
230 V AC/DC	VDR	CSA	UR / CSA	cURus / CSA
	VDR + LED			
	VDR-RC			
	RC		UR / CSA	
			26578	26317
	RC		UR / CSA	
			22052	26039
	RC		UR / CSA	
			22054	
400 V AC/DC	VDR			
	RC		UR / CSA	
			22054	

Technical Data

Damping factor	$\sim 1.5 \times U_N$
Temperature range	-20...+70 °C
Material	plastic, flame retardant (UL 94)
Connection wires	self-securing cable forks

Dimension drawing

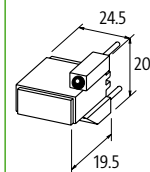
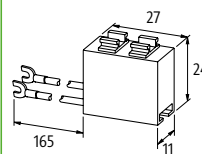
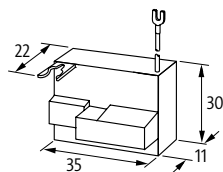

Notes

EMC SUPPRESSORS

Suppressors

– universal

AO



AD



CF



Circuit diagram

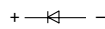

Diode

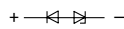

Diode/Z-Diode

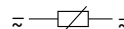

VDR

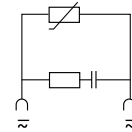

VDR-RC

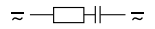

RC

Appropriate contactors

universal

universal

universal

Order Data

Order Data		Art.-No.	Art.-No.	Art.-No.	sugg. coil valves		
Voltage	Suppression	Approval	Approval	Approval	AO	AD	CF
Max. 240 V DC	Diode	CSA 26001			15 W		
24V DC	Z-Diode	CSA 26120	CSA 26073		25 W	75 W	
24V AC/DC	VDR	cURus / CSA 26180	CSA 26720		50 VA/W	200 VA/W	
	RC			CSA 20680			20 VA
48V AC/DC	VDR	cURus / CSA 26181			70 VA/W		
	RC	cURus / CSA 20001	cURus / CSA 20013		15 VA	15 VA	
110V AC/DC	VDR	cURus / CSA 26182	CSA 26722		100 VA/W	200 VA/W	
	VDR-RC						
230V AC/DC	RC						
	VDR	cURus / CSA 26183	CSA 26723		200 VA/W	200 VA/W	
400V AC/DC	VDR	cURus / CSA 26184			200 VA/W		
	RC		CSA 20014	CSA 20682		25 VA	20 VA
	RC	cURus / CSA 20002	cURus / CSA 20010	CSA 20683	15 VA	75 VA	20 VA
	RC		cURus / CSA 20011	CSA ³⁾ 20687		100 VA	50 VA
400V AC/DC	VDR		CSA 26724			200 VA/W	
	RC	cURus / CSA 20004	cURus / CSA 20012	CSA 20688	15 VA	100 VA	50 VA
RC							

Technical Data

Damping factor	approx. 1.5
Temperature range	-20...+70 °C
Material	plastic, flame retardant (UL 94)
Connection wires	self-securing cable forks

Dimension drawing

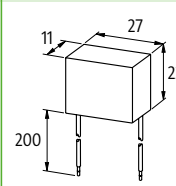
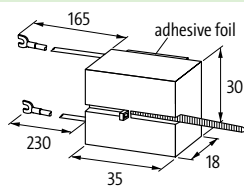
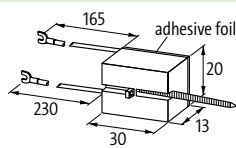

Form 1

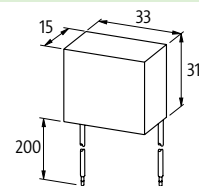

²⁾ Form 2

Notes

Art.-No. 26184 – up to 300 V AC/DC

EMC SUPPRESSORS

Suppressors

– universal

H

RC-BUG 2

BU + UB



Circuit diagram

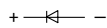

Diode

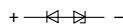

Diode/Z-Diode

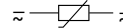

VDR

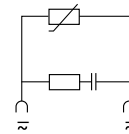

VDR-RC

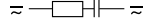

RC

Appropriate contactors

universal

universal

universal

Order Data

Order Data		Art.-No.	Art.-No.	Art.-No.	sugg. coil valves				
Voltage	Suppression	Approval	Approval	Approval	H	RC-BUG 2	BU + UB		
24...240 V DC	Diode	CSA	26097	CSA	26020	25 W	50 W		
24 V DC	Z-Diode	CSA	26095	CSA	26130	25 W	50 W		
24 V AC/DC	VDR	cURus / CSA	26090	cURus / CSA	26150	50 VA/W	50 VA/W		
	RC								
48 V AC/DC	VDR								
	RC	CSA	20100			15 VA			
110 V AC/DC	VDR								
	VDR-RC								
	RC			CSA	26613		146 VA		
230 V AC/DC	VDR			CSA	26619	cURus / CSA	26155	100 VA/W	200 VA/W
	RC	CSA	20101	CSA	26614	CSA	20031	15 VA	146 VA
	RC	CSA	20102	CSA		CSA	20033	25 VA	25 VA
	RC	CSA	20103			CSA	20034	75 VA	25 VA
400 V AC/DC	VDR								
	RC			CSA	26615	CSA	20032	146 VA	25 VA
	RC			CSA	26616			146 VA	

Technical Data

Damping factor	approx. 1.5	
Temperature range	-20...+70 °C	
Material	plastic, flame retardant (UL 94)	
Mounting method	DIN-rail mounting (EN 60715)	with adapter ASA Art.-No. 20900 , DIN-rail mounting (EN 60715)
Connection wires	self-securing cable forks	

Dimension drawing

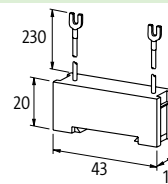
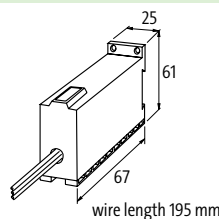
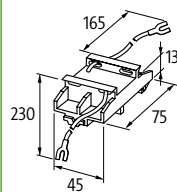

Notes

Art.-No. 20034 – without adapter, can be directly snapped onto DIN-rail, ASA adapter **Art.-No. 20900** included in delivery.
Art.-No. 26616 – up to 600 V AC/DC

EMC SUPPRESSORS

Suppressors for motors

Mounting methods:

- on the motor terminal box
- inside the motor terminal box
- inside the distribution box
- on 35 mm DIN-rail acc. to EN 60715

RC 3 U

M16 x 1.5



RC 3 BU



RC 3 BUG



Circuit diagram

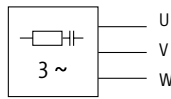

RC

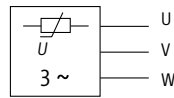

VDR

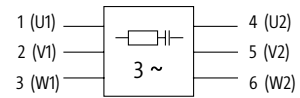

RC-(1) per phase

Order Data		Art.-No.	Art.-No.	Art.-No.
3 × 400 V AC	Motor rating	Suppression/Approval	Suppression/Approval	Suppression/Approval
	4 kW	RC	23022	RC / cURus
	4 kW			23050
	4 kW			VDR
	4 kW			23100
	4 kW			VDR / cURus
3 × 575 V AC	7.5 kW			23115
	7.5 kW			23115
	7.5 kW	RC	23011	VDR / cURus
	7.5 kW			23118
	7.5 kW	RC-per phase	23043	VDR / cURus
	7.5 kW			23118
3 × 690 V AC	10 kW			23118
	10 kW			23050
	10 kW			23050
	10 kW			23056
3 × 575 V AC	20 kW			23104
	20 kW			23102
	20 kW			23103
3 × 690 V AC	45 kW			23104
	4 kW			23104
	4 kW			23104
7.5 kW			23104	
20 kW			23104	

Technical Data

Frequency	for RC: 50...60 Hz; for VDR: 10...400 Hz		
Material	plastic, flame retardant (UL 94)		
Potting compound	2-component epoxy		
Temperature range	-20...+60 °C		
Connection method	approx. 500 mm PVC cable 3 × 0.75 mm ² or 7 × 0.75 mm ²	approx. 200 mm single core 0.35 mm ² ; Art.-No. 23056 0.5 mm ² with self-securing M4 cable forks M4	approx. 500 mm single core 1 mm ²

Dimension drawing

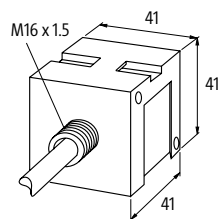

For DIN-rail mounting use
2 × **Art.- No. 20900** adapter feet

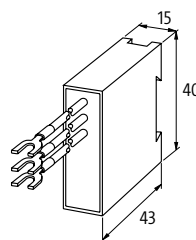

For DIN-rail mounting use
Art.- No. 20900 adapter feet

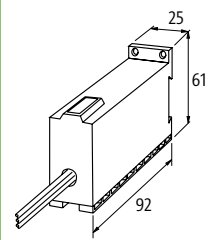

For DIN-rail mounting use
2 × **Art.- No. 20900** adapter feet

Notes

Do not use RC motor suppressors on variable frequency drives.
1 × **Art.-No. 23103, 23043** required per phase.

EMC SUPPRESSORS

Suppressors for motors

Mounting methods:

- with M16 × 1.5 and M20 × 1.5
- on the motor terminal box with plug connectors

RC 3 R

M16 × 1.5 screw



RC 3 R

M16 × 1.5 screw

RC 3 RG

M20 × 1.5 screw



Circuit diagram

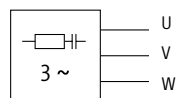

RC

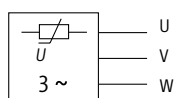

VDR

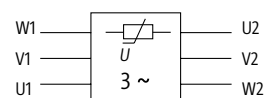

VDR-(1) per phase

Order Data		Art.-No.	Art.-No.	Art.-No.
Voltage	Motor rating	Suppression/Approval	Suppression/Approval	Suppression/Approval
3 × 400 V AC	4 kW	VDR / cURus	23170	VDR / cURus
	4 kW			
	4 kW			
	7.5 kW	VDR	23171	
	10 kW			VDR
3 × 575 V AC	20 kW			VDR
	4 kW	VDR / cURus	23172	RC / cURus
	7.5 kW	VDR / cURus	23173	
	10 kW			VDR / cURus
	20 kW			VDR / cURus
3 × 690 V AC	20 kW			VDR-Einzel
	7.5 kW	VDR	23174	
	20 kW			VDR

Technical Data

Frequency	for RC: 50...60 Hz; for VDR: 10...400 Hz		
Material	plastic, flame retardant (UL 94)		
Potting compound	2-component epoxy		
Temperature range	-20...+60 °C		
Connection method	approx. 100 mm single core 0.5 mm ²		approx. 150 mm single core 1 mm ²
Ring terminals	isolated M6	isolated M4	isolated M6

Dimension drawing

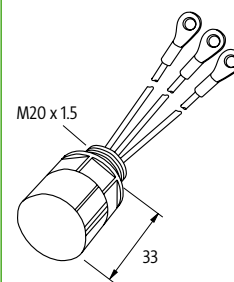
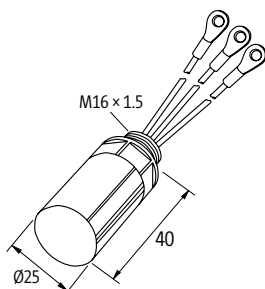

Notes

Do not use RC motor suppressors on variable frequency drives.
Art.-No. 23174 – wire diameter 1.5 mm².

EMC SUPPRESSORS

Suppressors for motors

Mounting methods:

- on the motor terminal box with plug connectors

RC 3 ST

Connector with cable and integrated motor suppression
Cable outlet in the back



RC 3 ST

Connector with cable and integrated motor suppression
Cable outlet (right angle)



Circuit diagram

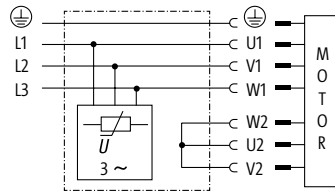

Varistor-suppression (star)

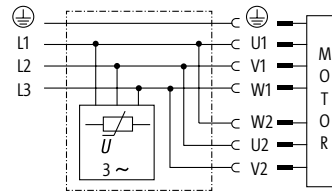

Varistor-suppression (delta)

Order Data			Art.-No.	Art.-No.
Voltage	Motor rating	Cable length	Suppression	Suppression
max.	5.5 kW	5 m	VDR/star	VDR/star
3 × 575 V AC	5.5 kW	8 m	VDR/star	
	5.5 kW	10 m	VDR/star	

Technical Data

Frequency	10...400 Hz	
Plug connector	females, 10-pol. + PE	
Housing	aluminium pressure diecasting	
Temperature range	-20...+60 °C	
Connection method	PUR cable black, 4 × 1.5 mm ² ; numbered wires, halogen free	PUR cable black, 4 × 1.5 mm ² ; numbered wires, DESINA® compliant

Dimension drawing

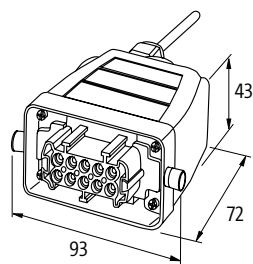

(without compression gland)

Notes

EMC SUPPRESSORS

Suppressors for motors

Mounting methods:

- on 35 mm DIN-rail acc. to EN 60715
- bolted together, stacked
- DIN-rail mounting under the control gear

HRC 3



HRC 3 K



RC 3 BUR

Connects onto Siemens SIRIUS 3 RT 20 contactors, with screw terminal



RC 3 BUC

Connects onto Siemens SIRIUS 3 RT 20 contactors, with spring clamp terminal



Circuit diagram

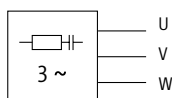

RC

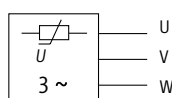

VDR

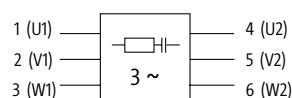

RC(1) per phase

Order Data		Art.-No.	Art.-No.	Art.-No.	Art.-No.
Voltage	Motor rating	Suppression/Approval	Suppression	Suppression/Approval	Suppression/Approval
3 × 400 V AC	4 kW	RC / cURus	23004	RC	23005
	4 kW	RC / cURus	233463		
	5.5 kW			RC / cURus	236082
	7.5 kW				RC / cURus
	10 kW	RC / cURus	23002	RC	23003
	20 kW	RC-per phase / cURus	23009		
3 × 500 V AC +10 %	20 kW	VDR / cURus	23015		
	4 kW	RC / cURus	23000	RC	23001
3 × 575 V AC	5.5 kW			RC / cURus	236082
	7.5 kW	RC / cURus	23006	RC	23007
	7.5 kW	RC / cURus	230563		RC / cURus
	10 kW	VDR / cURus	23016		
	20 kW			RC	23018
3 × 690 V AC	10 kW	RC	23017		

Technical Data

Frequency	for RC: 50...60 Hz; for VDR: 10...400 Hz				
Material	plastic, flame retardant (UL 94)				
Potting compound	2-component epoxy				
Temperature range	-20...+60 °C				
Connection method	approx. 250 mm s. core (Art.-No. 23000: 300 mm) 0.5 mm ² (Art.-No. 23000: 1.5 mm ²) with self-securing M4 cable forks	3-pole terminal 2 × (0.75...2.5 mm ²) M4	wire (solid core) 1.5 mm ²	wire with ferrule ends 2.0 mm ²	

Dimension drawing

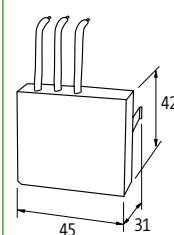
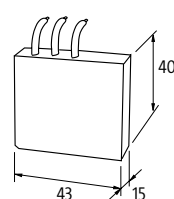
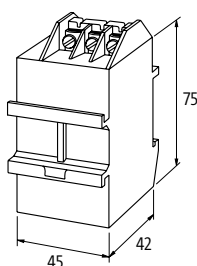
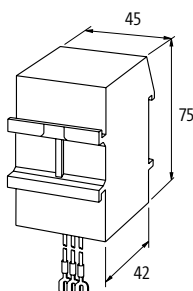

Notes

Do not use RC motor suppressors on variable frequency drives.
Art.-No. 233463 and **230563** – with ferrule ends.

EMC SUPPRESSORS

Suppressors for motors

Mounting methods:

- DIN-rail mounting under the control gear
- fixes onto contactors
- available with integrated coil suppression

HRC 3 AS



RC 3 RT

Connects onto Siemens SIRIUS 3 RT 10 contactors with screw terminal



Circuit diagram

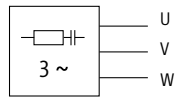

RC

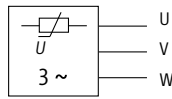

VDR

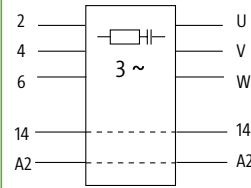

Appropriate contactors

Motor contactors up to 5.5 kW from Siemens, Moeller, Sprecher + Schuh etc.

Siemens 3 RT 10

Order Data		Art.-No.	Art.-No.	Art.-No.
Voltage	Motor rating	Suppression motor + coil	Suppression motor + coil	Suppression / Approval
3 × 400 V AC	5.5 kW	RC	23160	VDR
	5.5 kW	RC + Diode	23151	23163
3 × 575 V AC	5.5 kW	RC	23161	VDR
	5.5 kW			VDR + Diode
				23164
				23157
				RC / cURus / CSA
				23180
				RC / cURus / CSA
				23181

Technical Data

Suppression Spule	for RC: 230 V AC/20 VA; for RC + Diode: 24...230 V DC/36 W
Frequency	for RC: 50...60 Hz; for VDR: 10...400 Hz
Material	plastic, flame retardant (UL 94)
Temperature range	-20...+60 °C
Connection method	ferrules, load side securely fixed
	fits directly into SIRIUS contactors, size 00

Dimension drawing

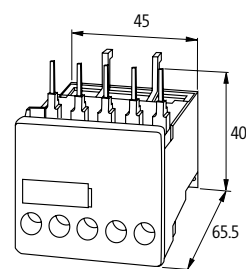
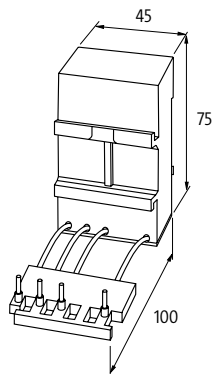

Notes

Do not use RC motor suppressors on variable frequency drives.

EMC SUPPRESSORS

Suppressors for valves

- with LED
- with suppression

VBS

Form A
Pin spacing 18 mm
EN 175301-803 (ISO 4400)



LBS

Form BI Industrial Standard
Pin spacing 11 mm



Circuit diagram

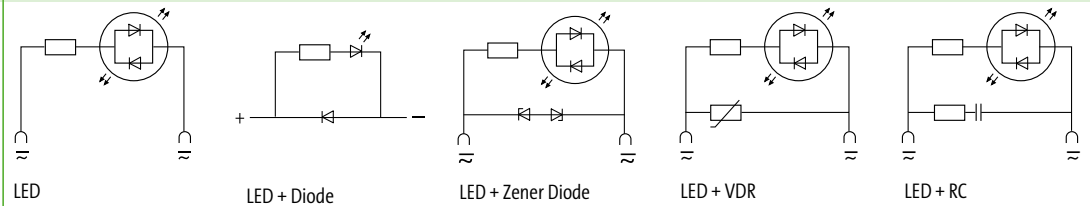

Order Data		Art.-No.	Art.-No.	Switch off delay time [ms]	Switch off voltage peak [V]	Valve hold-on rating [W/VA]
Voltage	Suppression					
24 V DC	LED + Diode	¹⁾ 3124021	3124221	200	1	50
24 V AC/DC	LED	¹⁾ 3124015	3124215	-	-	50
	LED + Z-Diode	¹⁾ 3124033	3124233	20	55	100
	LED + VDR	¹⁾ 3124048	3124248	15	45	50
	LED + RC	3124068		20	105	10
	LED + RC		3124269	20	70	20
48 V AC/DC	LED	¹⁾ 3124017		-	-	50
	LED + VDR	¹⁾ 3124052		10	75	100
	LED + RC	²⁾ 3124071		20	90	30
110 V AC/DC	LED	3124018		-	-	50
	LED + VDR	3124046		10	235	100
	LED + RC	3124070		20	250	10
	LED + RC	²⁾ 3124072		20	250	25
230 V AC/DC	LED	3124016	3124216	-	-	50
	LED + VDR	3124049	3124249	15	360	100
	LED + RC	3124063	3124263	20	300	10
	LED + RC	²⁾ 3124064		20	300	25

Technical Data

Supply indicator	LED yellow
Contact material	silvered bronze
Protection	IP65 when fully mounted
Material	polyamide black, flame retardant, temperature resistant up to 130 °C
Temperature range	-20...+60 °C

Dimension drawing

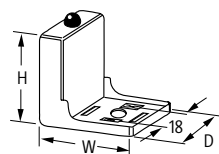

Housing H × W × D: 37 × 45 × 30 mm
¹⁾ Housing H × W × D: 37 × 39 × 30 mm
²⁾ Housing H × W × D: 37 × 53 × 33 mm
 0° and 180° version on request

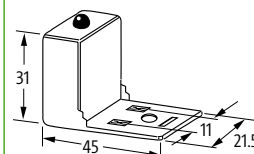

Note PIN arrangement (PE at cable outlet of connector)
 180° version on request

Notes

Do not use plug gasket when fitting adapter. Other LED colors on request.
 For double valves the VA 2 series is suitable (please inquire). At Art.-No. 3124021 and 3124221 polarity dependent

EMC SUPPRESSORS

Suppressors for valves

- with LED
- with suppression

DAB/PBS

Form B/BI
Pin spacing 10/11 mm
EN 175301-803 (ISO 6952)



MVK/MVT

Form C/CI
Pin spacing 8/9.4 mm
EN 175301-803 (ISO 6952)



Circuit diagram

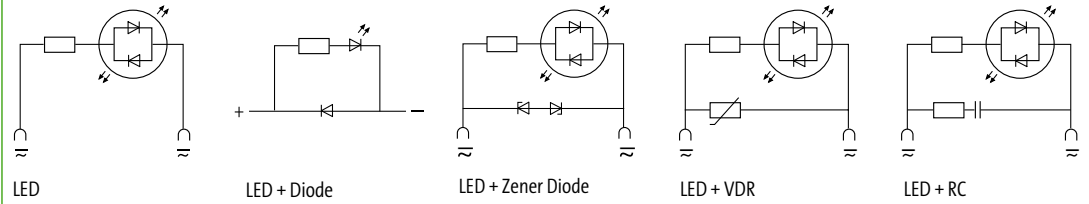

Order Data		Art.-No.	Art.-No.	Art.-No.	Art.-No.	Switch off delay time	Switch off voltage peak	Valve-hold-on rating
Voltage	Suppression	EN 175301-803 (ISO 6952)		EN 175301-803 (ISO 6952)		[ms]	[V]	[W/VA]
		Form B	Form BI	Form C	Form CI			
24 V DC	LED + Diode	3124871	3124121			200	1	50
24 V AC/DC	LED	3124875	3124115	3124811	3124815	-	-	50
	LED + Z-Diode	3124873	3124133	3124833	3124832	20	55	100
	LED + VDR		3124148			15	45	50
	LED + RC		3124169			20	70	20
110 V AC/DC	LED + RC		3124170			20	250	10
230 V AC/DC	LED		3124116			-	-	50
	LED + VDR					15	360	100
	LED + RC		3124163			20	300	10

Technical Data

Supply indicator	LED yellow
Contact material	silvered bronze
Protection	IP65 when fully mounted
Material	polyamide black, flame retardant, temperature resistant up to 130 °C
Temperature range	-20...+60 °C

Dimension drawing

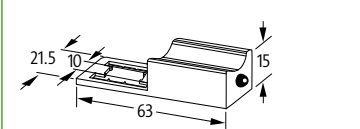

Suitable for 0° and 180° installation

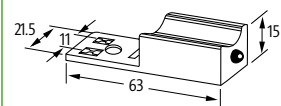

Note PIN arrangement
(PE at cable outlet of connector)
180° version on request

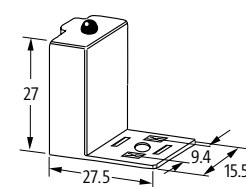
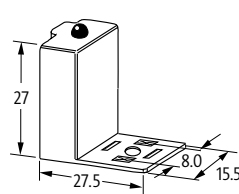

0° and 180° version on request

Notes

Do not use plug gasket when fitting adapter. Other LED colors on request. Right-angle housing version with 10 mm pin spacing (DAR/DARU), on request. At **Art.-No. 3124871** and **3124121** polarity dependent.

RELAYS / SAFETY RELAYS INCREDIBLY VERSATILE

- Over 600 different modules ready for all applications
- Push-In technology, spring clamps or screw terminals available
- Worldwide approvals

TWICE AS SMALL, TWICE AS FAST!

Each system includes different kinds of active interface modules. Relay modules are used to separate two different potential levels. The control side is galvanically isolated from the load/contact side and should be protected from the wrong voltage. These interfaces adjust the different signal levels to work with the existing system.

With MIRO SAFE+, Murrelektronik offers safe switching devices for a wide range of safe industrial applications. They are the perfect solution to reach high safety standards – up to performance level e (PLe) according to EN 13849-1. **With MIRO SAFE+ you can design many different safety applications like: emergency stops, guard doors, two hand monitoring, light curtains, and safety magnet switch monitoring.**

Relays



Relay 6.2 mm pluggable

- Output relay
- Input relay

Page 1.9.1



Relay 6.2 mm

- Output relay
- Input relay

Page 1.9.4



Relay 12.4 mm

- Output relay
- Input relay

Page 1.9.9



Relay 22.5 mm

- Output relay
- Input relay

Page 1.9.17

Safety Relays



Safety Relay 22.5/45 mm

- MIRO SAFE+

Page 1.9.20

RELAYS / SAFETY RELAYS

Terminal relay

– pluggable

– with bridge system

Approvals:

MIRO 6.2

Output relay
1 NO/NC contact
Spring clamp terminals



Circuit diagram

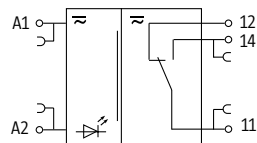

Order Data

	Art-No.
6 V AC/DC (5...7.2 V AC/DC) - 25 mA	3000-16023-3100022
12 V AC/DC (9.8...14 V AC/DC) - 14.2 mA	3000-16023-3100005
24 V AC/DC (19.2...28.8 V AC/DC) - 12 mA	3000-16013-3100020

Accessories

	Art-No.
Removable plug-in relay 6 V AC/DC	3000-16023-2100000
Removable plug-in relay 12 V AC/DC	3000-16023-2100005
Removable plug-in relay 24 V AC/DC	3000-16023-2100010

Utilization category

AC-12	6 A (24/110/230 V AC)
AC-15	3 A (24/110 V AC); 1.5 A (230 V AC)
DC-13	1 A (24 V DC); 0.2 A (110 V DC); 0.1 A (230 V DC)

Input

LED display	LED (green)
-------------	-------------

Output

Switching voltage	max. 250 V AC/30 V DC
Switching current per output	max. 6 A
Min. load current	100 mA
Power rating (voltage dependent)	max. 1 500 VA/180 W
Switching frequency	max. 10 Hz
Contact material	Ag Sn O ₂
Energize/release/contact bounce time	8/4/- ms

General data

Test isolation voltage	250 V
Mech./ elect. life	10 000 000 switching cycles (NO) 30 000; (NC) 10 000, load dependent
Protection	IP20
Mounting method	DIN-rail mountable (EN 60715)
Temperature range	-25...+60 °C

Dimension drawing

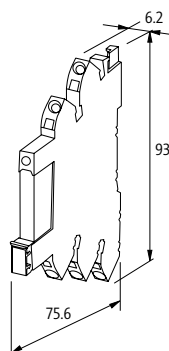

Notes

For inductive loads we recommend EMC suppressors connected parallel to the coil.

RELAYS / SAFETY RELAYS

Terminal relay

– pluggable

– with bridge system

MIRO 6.2

Output relay
1 NO/NC contact
Spring clamp terminals



Circuit diagram

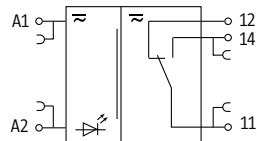

Order Data	Art-No.
60 V AC/DC (43.5...72 V AC/DC) - 7 mA	cURus, cCSAus 3000-16513-3100022
115...125 V AC/DC (88...138 V AC/DC) - 8 mA	3000-16013-3100025
230 V AC/DC (184...264 V AC/DC) - 4 mA	3000-16013-3100030

Accessories	Art-No.
Relay 60/125/230 V AC/DC	3000-16023-2100020

Utilization category	
AC-12	6 A (24/110/230 V AC)
AC-15	3 A (24/110 V AC); 1.5 A (230 V AC)
DC-13	1 A (24 V DC); 0.2 A (110 V DC); 0.1 A (230 V DC)

Input	
LED display	LED (green)

Output	
Switching voltage	max. 250 V AC/30 V DC
Switching current per output	max. 6 A
Min. load current	100 mA
Power rating (voltage dependent)	max. 1 500 VA/180 W
Switching frequency	max. 10 Hz
Contact material	Ag Sn O ₂
Energize/release/contact bounce time	8/4/- ms

General data	
Test isolation voltage	250 V
Mech./ elect. life	10 000 000 switching cycles (NO) 30 000; (NC) 10 000, load dependent
Protection	IP20
Mounting method	DIN-rail mountable (EN 60715)
Temperature range	-25...+60 °C

Dimension drawing

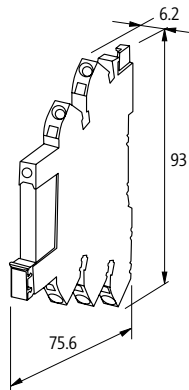

Notes	
	For inductive loads we recommend EMC suppressors connected parallel to the coil.

RELAYS / SAFETY RELAYS

Terminal relay

- pluggable
- with bridge system

Approvals:  

MIRO 6.2

Input relay
1 NO/NC contact
Spring clamp terminals



Circuit diagram

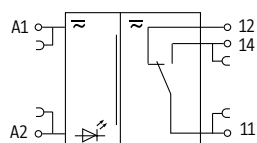

Order Data

24 V AC/DC (19.2...26.8 V AC/DC) - 14 mA

Art-No.

3000-16013-3100040

Accessories

Removable plug-in relay 24 V AC/DC

Art-No.

3000-16023-2100030

Utilization category

AC-12	6 A (24/110/230 V AC)
AC-15	3 A (24/110 V AC); 1.5 A (230 V AC)
DC-13	1 A (24 V DC); 0.2 A (110 V DC); 0.1 A (230 V DC)

Input

LED display LED (green)

Output

Switching voltage	max. 250 V AC/30 V DC
Switching current per output	max. 6 A
Min. load current	10 mA
Power rating (voltage dependent)	max. 1 500 VA/180 W
Switching frequency	max. 10 Hz
Contact material	Ag Sn O ₂ , gold plated
Energize/release/contact bounce time	8/4/- ms

General data

Test isolation voltage	250 V
Mech./ elect. life	10 000 000 switching cycles (NO) 30 000; (NC) 10 000, load dependent
Protection	IP20
Mounting method	DIN-rail mountable (EN 60715)
Temperature range	-25...+60 °C

Dimension drawing

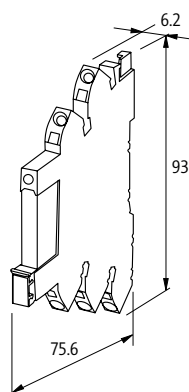

Notes

For inductive loads we recommend EMC suppressors connected parallel to the coil. When the max. switching voltage/current is exceeded the gold plating is destroyed. The relay will then take on the properties of an output type.

RELAYS / SAFETY RELAYS

Terminal relay

– with bridge system

Approvals:  

MIRO 6.2

Output relay
1 NO/NC contact
Screw terminals



MIRO 6.2

Output relay
1 NO/NC contact
Spring clamp terminals



MIRO 6.2

Output relay
1 NO contact
Screw terminals



MIRO 6.2

Output relay
1 NO contact
Spring clamp terminals



Circuit diagram

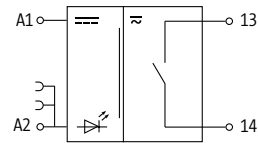
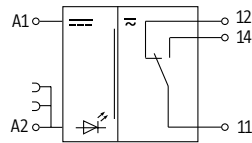

Order Data	Art-No.	Art-No.	Art-No.	Art-No.
12 V DC (10...15 V DC) - 20 mA	52050	6652050		
24 V DC (19.2...30 V DC) - 14 mA	CCC 52000	CCC 6652000	CCC 52002	CCC 6652002
24 V DC (19.2...30 V DC) - 17 mA	CCC 52001	CCC 6652001	CCC 52015	CCC 6652015

Utilization category

AC-12	6 A (24/110/230 V AC)
AC-15	3 A (24/110/230 V AC)
DC-13	1 A (24 V DC); 0.2 A (110 V DC); 0.1 A (230 V DC)

Input	Output
LED display	LED (green)
Switching voltage	max. 250 V AC/DC
Switching current per output	max. 6 A
Min. load current	10 mA (12 V DC) 100 mA (12 V DC)
Power rating (voltage dependent)	max. 1 500 VA/120 W
Switching frequency	max. 10 Hz
Contact material	Ag Sn O ₂
Energize/release/contact bounce time	10/15/1.5 ms

General data

Mech./ elect. life	20 000 000 switching cycles/load dependent
Test isolation voltage	4 kV; safe separation (EN 60947-1)
Mounting method	DIN-rail mountable (EN 60715)
Temperature range	-20...+55 °C

Dimension drawing

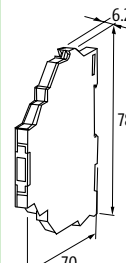
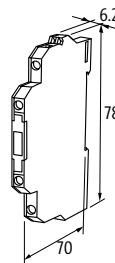
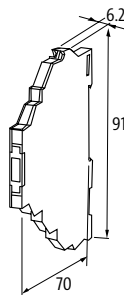
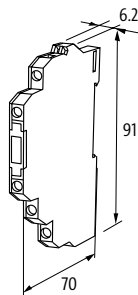

Notes

For inductive loads we recommend EMC suppressors connected parallel to the coil.

RELAYS / SAFETY RELAYS

Terminal relay

– with bridge system

Approvals:   

MIRO 6.2

Output relay
1 NO/NC contact
Screw terminals



MIRO 6.2

Output relay
1 NO/NC contact
Spring clamp terminals



Circuit diagram

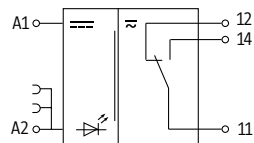

Order Data

110 V AC/DC (95...121 V AC/DC) - 4 mA
230 V AC/DC (195...253 V AC/DC) - 3 mA

Art-No.

52030

CCC

52040

CCC

Art-No.

6652030

6652040

Utilization category

AC-12 6 A (24/110/230 V AC)
AC-15 3 A (24/110/230 V AC)
DC-13 1 A (24 V DC); 0.2 A (110 V DC); 0.1 A (230 V DC)

Input

LED display

LED (green)

Output

Switching voltage max. 250 V AC/DC
Switching current per output max. 6 A
Min. load current 10 mA (12 V DC)
Power rating (voltage dependent) max. 1 500 VA/120 W
Switching frequency max. 10 Hz
Contact material Ag Sn O2
Energize/release/contact bounce time 10/15/1.5 ms

General data

Mech./ elect. life 20 000 000 switching cycles/load dependent
Test isolation voltage 4 kV; safe separation (EN 60947-1)
Mounting method DIN-rail mountable (EN 60715)
Temperature range -20...+55 °C

Dimension drawing

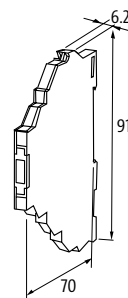
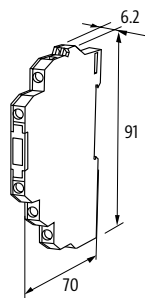

Notes

For inductive loads we recommend EMC suppressors connected parallel to the coil.

RELAYS / SAFETY RELAYS

Terminal relay

– with bridge system

Approvals:   

MIRO 6.2

Input relay
1 NO/NC contact
Screw terminals



MIRO 6.2

Input relay
1 NO/NC contact
Spring clamp terminals



Circuit diagram

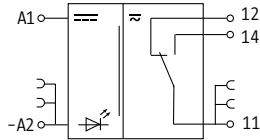

Order Data	Art-No.	Art-No.
24 V DC (19.2...30 V DC) - 14 mA	52005	6652005
24 V AC/DC (19.2...30 V AC/DC) - 16 mA	52003	6652003

Utilization category

AC-12	6 A (24/110/230 V AC)
AC-15	3 A (24/110/230 V AC)
DC-13	1 A (24 V DC); 0.2 A (110 V DC); 0.1 A (230 V DC)

Input	Output
LED display	LED (yellow)
Switching voltage	max. 30 V AC/36 V DC
Switching current per output	max. 6 A
Switching current per output (Signal)	max. 20 mA
Min. load current	1 mA (12 V DC)
Power rating (voltage dependent)	max. 1 500 VA/120 W
Switching frequency	max. 10 Hz
Contact material	Ag Sn O2 hv
Energize/release/contact bounce time	10/15/1.5 ms

General data

Mech./ elect. life	20 000 000 switching cycles/load dependent
Test isolation voltage	4 kV; safe separation (EN 60947-1)
Mounting method	DIN-rail mountable (EN 60715)
Temperature range	-20...+55 °C

Dimension drawing

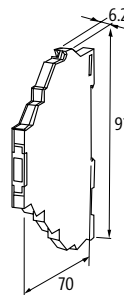
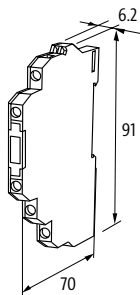

Notes

For inductive loads we recommend EMC suppressors connected parallel to the coil. When the max. switching voltage/current is exceeded the gold plating is destroyed. The relay will then take on the properties of an output type.

RELAYS / SAFETY RELAYS

Terminal relay

– with bridge system

Approvals:   

MIRO 6.2

Input relay
1 NO contact
Screw terminals



MIRO 6.2

Input relay
1 NO contact
Spring clamp terminals



Circuit diagram

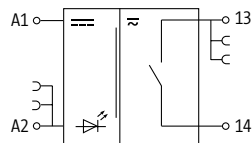

Order Data

24 V DC (19.2...30 V DC) - 14 mA

Art-No.

52004

Art-No.

6652004

Utilization category

AC-12	6 A (24/110/230 V AC)	
AC-15	3 A (24/110/230 V AC)	
DC-13	1 A (24 V DC); 0.2 A (110 V DC); 0.1 A (230 V DC)	3 A (24/110/230 V AC)

Input

LED display LED (yellow)

Output

Switching voltage	max. 30 V AC/36 V DC
Switching current per output	max. 50 mA
Min. load current	1 mA (12 V DC)
Power rating (voltage dependent)	max. 1 500 VA/120 W
Switching frequency	max. 10 Hz
Contact material	Ag Sn O2 hv
Energize/release/contact bounce time	10/15/1.5 ms

General data

Mech./ elect. life	20 000 000 switching cycles/load dependent
Test isolation voltage	4 kV; safe separation (EN 60947-1)
Mounting method	DIN-rail mountable (EN 60715)
Temperature range	-20...+55 °C

Dimension drawing

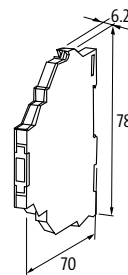
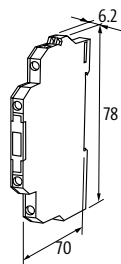

Notes

For inductive loads we recommend EMC suppressors connected parallel to the coil. When the max. switching voltage/current is exceeded the gold plating is destroyed. The relay will then take on the properties of an output type.

RELAYS / SAFETY RELAYS

Terminal relay

– with bridge system

Approvals:  

MIRO 6.2

Input relay
1 NO/NC contact
Screw terminals



MIRO 6.2

Input relay
1 NO/NC contact
Spring clamp terminals



Circuit diagram

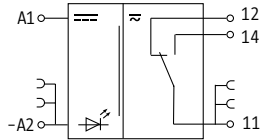

Order Data	Art-No.	Art-No.
110 V AC/DC (95...121 V AC/DC) - 4 mA	52031	6652031
230 V AC/DC (195...253 V AC/DC) - 3 mA	52041	6652041

Utilization category	CCC	CCC
AC-12	6 A (24/110/230 V AC)	
AC-15	3 A (24/110/230 V AC)	
DC-13	1 A (24 V DC); 0.2 A (110 V DC); 0.1 A (230 V DC)	

Input	
LED display	LED (yellow)
Output	
Switching voltage	max. 30 V AC/36 V DC
Switching current per output	max. 6 A
Switching current per output (Signal)	max. 20 mA
Min. load current	1 mA (12 V DC)
Power rating (voltage dependent)	max. 1 500 VA/120 W
Switching frequency	max. 10 Hz
Contact material	Ag Sn O2 hv
Energize/release/contact bounce time	10/15/1.5 ms

General data	
Mech./ elect. life	20 000 000 switching cycles/load dependent
Test isolation voltage	4 kV; safe separation (EN 60947-1)
Mounting method	DIN-rail mountable (EN 60715)
Temperature range	-20...+55 °C

Dimension drawing

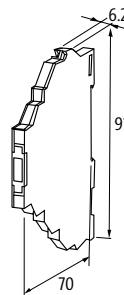
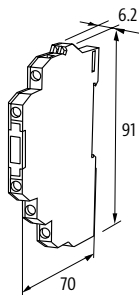

Notes	
	For inductive loads we recommend EMC suppressors connected parallel to the coil. When the max. switching voltage/current is exceeded the gold plating is destroyed. The relay will then take on the properties of an output type.

RELAYS / SAFETY RELAYS

Terminal relay

– with bridge system

MIRO 12.4

Output relay
2 NO/NC contacts
Screw terminals



MIRO 12.4

Output relay
2 NO/NC contacts
Spring clamp terminals



MIRO 12.4

Input relay
2 NO/NC contacts
Screw terminals



MIRO 12.4

Input relay
2 NO/NC contacts
Spring clamp terminals



Approvals: **ULus**

Circuit diagram

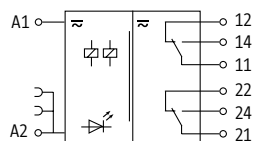

Order Data

	Art-No.	Art-No.	Art-No.	Art-No.
24 V DC (19.2...30 V DC) - 18 mA	cCSAus, CCC 52102	cCSAus, CCC 6652102	CCC 52110	CCC 6652110
24 V AC/DC (19.2...30 V AC/DC) - 20 mA	CCC 52103	CCC 6652103	CCC 52111	CCC 6652111
110 V AC/DC (95...121 V AC/DC) - 7 mA	CCC 52130	CCC 6652130	CCC 52136	CCC 6652136
230 V AC/DC (195...253 V AC/DC) - 5 mA	CCC 52140	CCC 6652140	CCC 52146	CCC 6652146

Utilization category

AC-12	6 A (24/110/230 V AC)
AC-15	3 A (24/110/230 V AC)
DC-13	1 A (24 V DC); 0.2 A (110 V DC); 0.1 A (230 V DC)

Input

LED display LED (green)

Output

Switching voltage	max. 250 V AC/DC	max. 30 V AC/36 V DC
Switching current per output	max. 6 A	
Switching current per output (Signal)	–	max. 20 mA
Min. load current	100 mA (12 V DC)	1 mA (12 V DC)
Power rating (voltage dependent)	max. 1 500 VA/120 W	
Switching frequency	max. 10 Hz	
Contact material	Ag Sn O2	Ag Sn O2 hv
Energize/release/contact bounce time	10/15/1.5 ms	

General data

Mech./ elect. life	20 000 000 switching cycles/load dependent
Test isolation voltage	4 kV; safe separation (EN 60947-1)
Mounting method	DIN-rail mountable (EN 60715)
Temperature range	-20...+55 °C

Dimension drawing

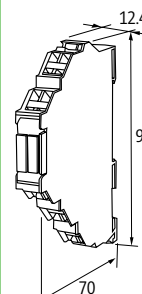
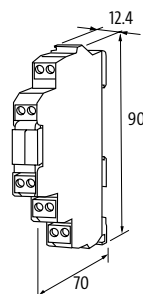
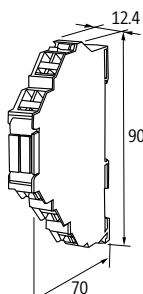
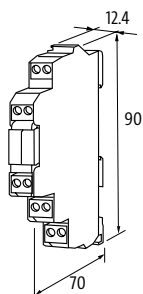

Notes

For inductive loads we recommend EMC suppressors connected parallel to the coil.

RELAYS / SAFETY RELAYS

Terminal relay

– with bridge system

MIRO 12.4

Output relay
2 NO contact
Screw terminals



MIRO 12.4

Output relay
2 NO contact
Spring clamp terminals



MIRO 12.4

Output relay
2 NO contact
Screw terminals



MIRO 12.4

Output relay
2 NO contact
Spring clamp terminals



Approvals:

Circuit diagram

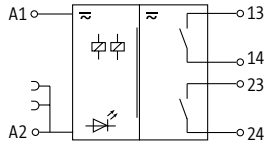

Order Data	Art-No.	Art-No.	Art-No.	Art-No.
24 V AC/DC (19.2...30 V AC/DC) - 20 mA	52104	6652104		
24 V AC/DC (19.2...30 V AC/DC) - 16 mA			52106	6652106

Utilization category

AC-12	6 A (24/110/230 V AC)
AC-15	3 A (24/110/230 V AC)
DC-13	1 A (24 V DC); 0.2 A (110 V DC); 0.1 A (230 V DC)

Input

LED display LED (green)

Output

Switching voltage	max. 250 V AC/DC
Switching current per output	max. 6 A
Min. load current	100 mA (12 V DC)
Power rating (voltage dependent)	max. 1 500 VA/120 W
Switching frequency	max. 10 Hz
Contact material	Ag Sn O2
Energize/release/contact bounce time	10/15/1.5 ms

General data

Mech./ elect. life	20 000 000 switching cycles/load dependent
Test isolation voltage	4 kV; safe separation (EN 60947-1)
Mounting method	DIN-rail mountable (EN 60715)
Temperature range	-20...+55 °C

Dimension drawing

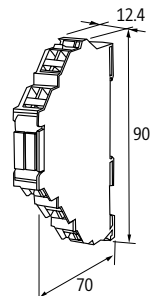
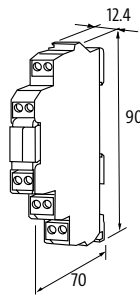
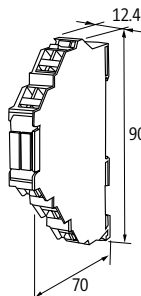
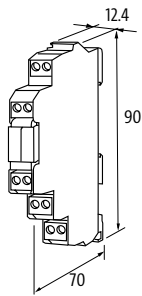

Notes

For inductive loads we recommend EMC suppressors connected parallel to the coil.

RELAYS / SAFETY RELAYS

Terminal relay

MIRO 12.4 Multi voltage

Output relay
1 NO/NC contact
Screw terminals



Approvals: 

Circuit diagram

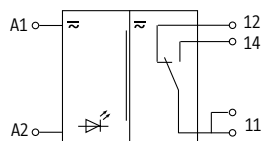

Order Data

	Art-No.
24 V AC/DC - 6...27 mA	52160
48 V DC - 6...27 mA	52160
110 V AC/DC - 6...27 mA	52160
230 V AC/DC - 6...27 mA	52160

Utilization category

AC-12	6 A (24/110/230 V AC)
AC-15	3 A (24/110/230 V AC)
DC-13	1 A (24 V DC); 0.2 A (110 V DC); 0.1 A (230 V DC)

Input

LED display	LED (green)
-------------	-------------

Output

Switching voltage	max. 250 V AC/DC
Switching current per output	max. 6 A
Min. load current	10 mA (12 V DC)
Power rating (voltage dependent)	max. 1 500 VA/120 W
Switching frequency	max. 10 Hz
Contact material	Ag Sn O ₂
Energize/release/contact bounce time	10/15/1.5 ms

General data

Mech./ elect. life	20 000 000 switching cycles/load dependent
Test isolation voltage	4 kV; safe separation (EN 60947-1)
Mounting method	DIN-rail mountable (EN 60715)
Temperature range	-20...+55 °C

Dimension drawing

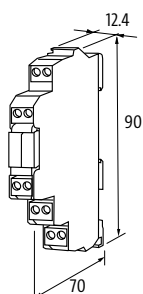

Notes

For inductive loads we recommend EMC suppressors connected parallel to the coil.

RELAYS / SAFETY RELAYS

Relays

- Screw terminals
- with minus plug link

RMM

Output relay
1 relay; 1 NO contact



RMM

Output relay
1 relay; 1 NC contact

Circuit diagram

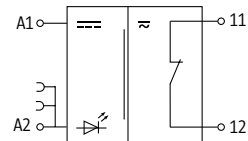
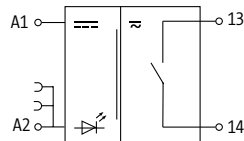

Order Data		Art-No.	Art-No.
24 V AC/DC (19.2...30 V AC/DC) - 15 mA		51851	51808

Utilization category			
AC-1	5 A (24/110/230 V AC)		
AC-15	3 A (24/110/230 V AC)		
DC-13	1.5 A (24 V DC); 0.3 A (110 V DC); 0.15 A (230 V DC)	1.3 A (24 V DC); 0.3 A (110 V DC); 0.15 A (230 V DC)	

Input		
Plug link (supplied)	Art.-No. 90960	
LED display	LED (red)	
Output		
Switching voltage	max. 250 V AC/300 V DC	
Switching current per output	max. 5 A	
Min. load current	100 mA	
Power rating (voltage dependent)	max. 1 250 VA/240 W	
Switching frequency	max. 10 Hz	
Contact material	Ag Ni 0.15 hv	
Energize/release/contact bounce time	10/15/1.5 ms	

General data		
Mech./ elect. life	10 000 000 switching cycles/load dependent	20 000 000 switching cycles/load dependent
Test isolation voltage	4 kV	
Mounting method	DIN-rail mountable TH35 or G32 (EN 60715)	
Temperature range	-20...+60 °C	

Dimension drawing

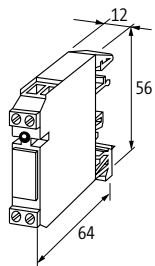

Notes

RELAYS / SAFETY RELAYS

Relays

– Screw terminals

RMM

Output relay
1 relay; 1 NO contact



RMM

Output relay
1 relay; 1 NC contact

Circuit diagram

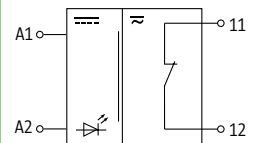
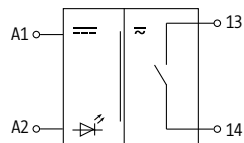

Order Data

	Art-No.	Art-No.	Art-No.	Art-No.
24 V AC/DC (19.2...30 V AC/DC) - 15 mA	51551	512764		51508
110 V AC/DC (95...121 V AC/DC) - 3.5 mA			51552	
230 V AC/DC (195...250 V AC/DC) - 3.5 mA			51515	
230 V AC/DC (195...250 V AC/DC) - 4 mA				51562

Utilization category

AC-12	–	6 A (24/110/230 V AC)	5 A (24/110/230 V AC)
AC-1	5 A (24/110/230 V AC)	–	
AC-15	3 A (24/110/230 V AC)		4 A (24/110/230 V AC) 3 A (24/110/230 V AC)
DC-13	1.5 A (24 V DC); 0.3 A (110 V DC); 0.15 A (230 V DC)	1 A (24 V DC); 0.2 A (110 V DC); 0.1 A (230 V DC)	2 A (24 V DC); 0.25 A (110 V DC); 0.1 A (230 V DC) 1.3 A (24 V DC); 0.3 A (110 V DC); 0.15 A (230 V DC)

Input

LED display	LED (red)	LED (green)	LED (red)
-------------	-----------	-------------	-----------

Output

Switching voltage	max. 250 V AC/300 V DC
Switching current per output	max. 5 A
Min. load current	100 mA
Power rating (voltage dependent)	max. 1 250 VA/240 W
Switching frequency	max. 10 Hz
Contact material	Ag Ni 0.15 hv; Ag hv
Energize/release/contact bounce time	10/15/1.5 ms

General data

Mech./ elect. life	20 000 000 switching cycles/load dependent
Test isolation voltage	4 kV
Mounting method	DIN-rail mountable TH35 or G32 (EN 60715)
Temperature range	-20...+50 °C

Dimension drawing

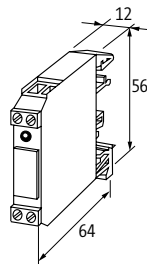

Notes

RELAYS / SAFETY RELAYS

Relays

– Screw terminals

RMME

Input relay
1 relay; 1 NO contact
with minus plug link



RMME

Input relay
1 relay; 1 NO contact



RMME

Input relay
1 relay; 1 NC contact

Circuit diagram

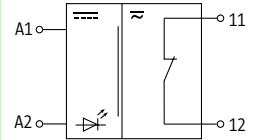
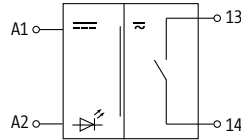
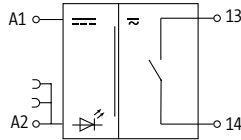

Order Data	Art-No.	Art-No.	Art-No.	Art-No.
24 V AC/DC (21.6...26.4 V AC/DC) - 6 mA	51860			
24 V AC/DC (19.2...30 V AC/DC) - 6 mA		51560		
110 V AC/DC (95...121 V AC/DC) - 3.5 mA		51526		
230 V AC (195...253 V AC) - 6 mA			51517	
24 V AC/DC (19.2...30 V AC/DC) - 15 mA				51571

Utilization category

AC-15	1 A (24 V AC); 0.5 A (125 V AC)	0.25 A (50 V AC)	3 A (24/110/230 V AC)
DC-13	1 A (24 V DC); 0.5 A (125 V DC)	–	1.5 A (24 V DC); 0.3 A (110 V DC); 0.15 A (230 V DC)
AC-1	–		5 A (24/110/230 V AC)
AC-12	–	0.5 A (50 V AC)	–

Input

Plug link (supplied)	Art-No. 90960	–
LED display	LED (yellow)	

Output

Switching voltage	max. 125 V AC/DC
Switching current per output	max. 1 A
Min. load current	1 mA
Power rating (voltage dependent)	max. 60 VA/30 W
Switching frequency	max. 15 Hz
Contact material	Pd Ni-Au Rh
Energize/release/contact bounce time	10/10/1 ms

General data

Mech./ elect. life	100 000 000 switching cycles/load dependent
Test isolation voltage	1.5 kV
Mounting method	DIN-rail mountable TH35 or G32 (EN 60715)
Temperature range	-20...+60 °C

Dimension drawing

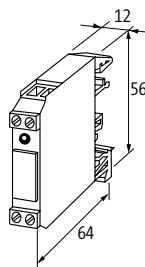
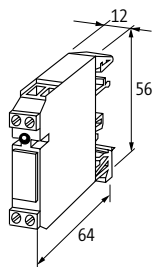

Notes

RELAYS / SAFETY RELAYS

Relays

– with minus plug link

– Screw terminals

RMMD

Output relay
1 relay; 1 NO contact



RMMD

Output relay
1 relay; 1 NO/NC contact

Circuit diagram

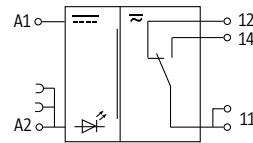
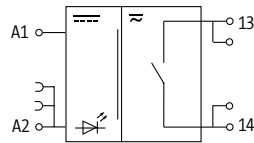

Order Data

	Art-No.	Art-No.	Art-No.	Art-No.
24 V DC (21.6...26.4 V DC) - 13.5 mA	51100			
230 V AC/DC (195...253 V AC/DC) - 4.5 mA		51108		
24 V DC (21.6...26.4 V DC) - 15 mA			51120	
24 V AC/DC (19.2...30 V AC/DC) - 10 mA				51125

Utilization category

AC-1	8 A (24/110/230 V AC)	6 A (24/110/230 V AC)	8 A (24/110/230 V AC)
AC-15	3 A (24/110/230 V AC)	4 A (24/110/230 V AC)	3 A (24/110/230 V AC)
DC-13	2.5 A (24 V DC); 0.4 A (110 V DC); 0.3 A (230 V DC)	2 A (24 V DC); 0.25 A (110 V DC); 0.1 A (230 V DC)	2.5 A (24 V DC); 0.4 A (110 V DC); 0.3 A (230 V DC)

Input

Plug link (supplied)	Art.-No. 90960	–	Art.-No. 90960
LED display	LED (red)		

Output

Switching voltage	max. 250 V AC/DC		
Switching current per output	max. 8 A	max. 6 A	max. 8 A
Min. load current	100 mA		
Power rating (voltage dependent)	max. 2 000 VA/240 W		
Switching frequency	max. 10 Hz		
Contact material	Ag Ni		
Energize/release/contact bounce time	10/15/2 ms		

General data

Mech./ elect. life	20 000 000 switching cycles/load dependent		
Test isolation voltage	5 kV; safe separation (IEC 61140/EN 61140)	4 kV	5 kV; safe separation (IEC 61140/EN 61140)
Temperature range	-20...+50 °C		
Mounting method	DIN-rail mountable TH35 or G32 (EN 60715)		

Dimension drawing

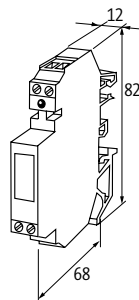

Notes

Art.-No. 51125 with low connection current.

RELAYS / SAFETY RELAYS

Relays

- with minus plug link
- with bridge system
- Screw terminals

RMMDE

Input relay
1 relay; 1 NO contact/1 NC contact



RMMDE

Input relay
1 relay; 1 NO/NC contact

RMMDE

Input relay
1 relay; 2 NO contacts

Circuit diagram

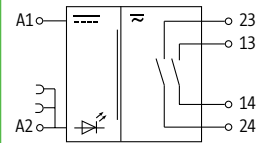
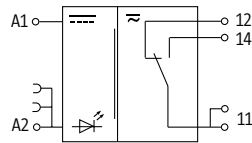
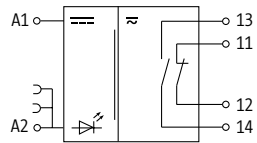

Order Data	Art-No.	Art-No.	Art-No.	Art-No.
24 V DC (17.5...30 V DC) - 14 mA	516014			
24 V DC (19.2...30 V DC) - 17 mA		51130		
230 V AC/DC (195...253 V AC/DC) - 4.5 mA			51138	
24 V DC (19.2...30 V DC) - 15 mA				51140
Utilization category				
AC1	3 A (24 V AC); 2 A (230 V AC)	5 A (24/110/230 V AC)		2 A (24 V AC; 110 V AC; 230 V AC)
AC15	1 A (24 V AC); 0.1 A (230 V AC)	3 A (24/110/230 V AC)	4 A (24/110/230 V AC)	1 A (24 V AC); 0.1 A (230 V AC)
DC13	0.8 A (24 V DC); 0.01 A (230 V DC)	1.3 A (24 V DC); 0.25 A (110 V DC); 0.10 A (230 V DC)	2 A (24 V DC); 0.25 A (110 V DC); 0.1 A (230 V DC)	0.8 A (24 V DC); 0.1 A (110 V DC); 0.01 A (230 V DC)
Input				
Plug link (supplied)	Art-No. 90960		-	Art-No. 90960
LED display	LED (red)	LED (yellow)		
Output				
Switching voltage	max. 250 V AC/DC			
Switching current per output	max. 3 A	max. 20 mA	max. 5 A	max. 2 A
Min. load current	1 mA			5 mA
Power rating (voltage dependent)	max. 500 VA/180 W	max. 1 500 VA/180 W		max. 250 VA/150 W
Switching frequency	max. 10 Hz	max. 15 Hz		
Contact material	Ag Ni 0.15 hv	Ag Ni 0.15 hv; Ag hv		Ag Au
Energize/release/contact bounce time	6/3/2 ms		10/10/1 ms	
General data				
Mech./ elect. life	20 000 000 switching cycles/load dependent	100 000 000 switching cycles/load dependent		20 000 000 switching cycles/load dependent
Test isolation voltage	2.5 kV	4 kV		1.5 kV
Mounting method	DIN-rail mountable TH35 or G32 (EN 60715)			
Temperature range	-20...+60 °C			-20...+50 °C
Dimension drawing				

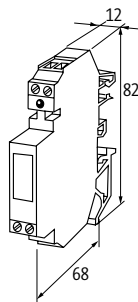

Notes

Relays

– Screw terminals

RM

Output relay
1 relay; 2 NO/NC contacts



RM

Output relay
1 relay; 4 NO/NC contacts

RM

Output relay
2 relays; each 1 NO/NC contact

RM

Output relay
2 relays; each 2 NO/NC contacts

Circuit diagram

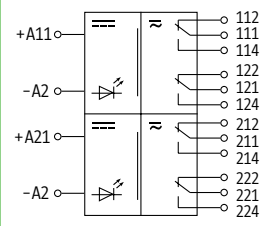
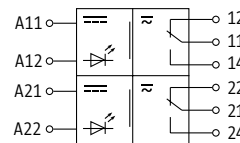
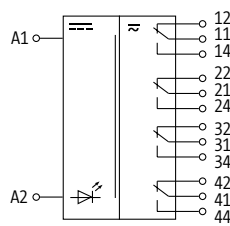
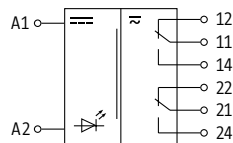

Order Data	Art-No.	Art-No.	Art-No.	Art-No.
24 V AC/DC (20.4...26.4 V AC/DC) - 20 mA	51540	51410		
230 VAC (195...250 VAC) - 10 mA		51413	51412	
24 V AC/DC (19.2...30 V AC/DC) - 10 mA			51485	
24 V AC/DC (19.2...30 V AC/DC) - 14 mA				51465

Utilization category				
AC-1	8 A (24/110/230 V AC)	–	8 A (24/110/230 V AC)	
AC-12	–	2 A (24 V AC); 0.5 A (230 V AC)	–	
AC-15	3 A (24/110/230 V AC)	1 A (24 V AC); 0.1 A (230 V AC)	3 A (24/110/230 V AC)	
DC-13	2 A (24 V DC); 0.3 A (110 V DC); 0.2 A (230 V DC)	0.8 A (24 V DC); 0.01 A (230 V DC)	1.5 A (24 V DC); 0.3 A (110 V DC); 0.15 A (230 V DC)	2 A (24 V DC); 0.3 A (110 V DC); 0.2 A (230 V DC)

Input	
LED display	LED (red)

Output				
Switching voltage	max. 250 V AC/DC			
Switching current per output	max. 8 A	max. 2 A	max. 8 A	
Min. load current	100 mA	0.1 mA	100 mA	
Power rating (voltage dependent)	max. 1 250 VA/240 W	max. 125 VA/60 W	max. 1 250 VA/240 W	
Switching frequency	max. 0.1 Hz (with load)			
Contact material	Ag Ni 0.15 hv	Ag Au	Ag Sn O2	Ag Ni 0.15 hv
Energize/release/contact bounce time	10/10/2 ms	10/20/2 ms	10/10/2 ms	

General data			
Mech./ elect. life	50 000 000 switching cycles/load dependent		20 000 000 switching cycles/load dependent
Test isolation voltage	4 kV	1.5 kV	4 kV
Mounting method	DIN-rail mountable TH35 or G32 (EN 60715)		
Temperature range	-20...+50 °C		

Dimension drawing

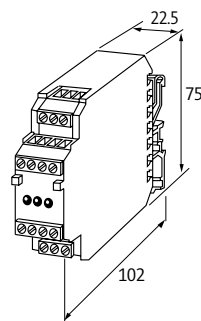

Notes

RELAYS / SAFETY RELAYS

Relays

- Screw terminals
- with force guided contacts

RM

Output relay
1 relay; 2 NO contacts/2 NC contacts



RM

Output relay
1 relay; 3 NO contacts/1 NC contact

MKS

Output relay
1 relay; 1 NO contact/1 NC contact



Circuit diagram

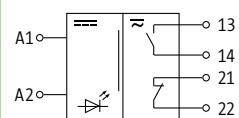
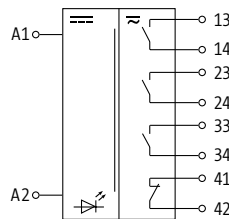
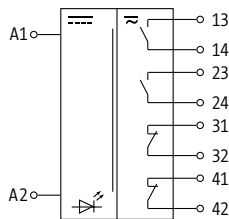

Order Data	Art-No.	Art-No.	Art-No.
24 V DC (21.6...28 V DC) - 29 mA	51300		
24 V DC (21.6...28 V DC) - 30 mA		51301	
24 V AC/DC (21.6...28 V AC/DC) - 38 mA			51302
Utilization category			
AC-1	5 A (24/110/230 V AC)		6 A (24/110/230 V AC)
DC-13	2 A (24 V DC); 0.4 A (110 V DC); 0.2 A (230 V DC)		3 A (24 V DC); 0.22 A (110 V DC); 0.1 A (230 V DC)
AC-15	4 A (24 V AC); 3 A (110 V AC); 2 A (230 V AC)		3 A (24/110/230 V AC)
Input			
LED display	LED (red)		LED (green)
Output			
Switching voltage	max. 250 V AC/DC		
Switching current per output	max. 5 A		max. 6 A
Min. load current	300 mA		10 mA
Power rating (voltage dependent)	max. 1 000 VA/50 W		max. 1 500 VA/100 W
Switching frequency	max. 0.1 Hz (with load)	max. 1 Hz	max. 5 Hz
Contact material	Ag Ni 10 hv	Ag hv; Ag Sn O2	Ag Ni 10 hv
Energize/release/contact bounce time	15/15/2 ms		15/15/1.5 ms
General data			
Mech./ elect. life	1 000 000 switching cycles/load dependent		10 000 000 switching cycles/load dependent
Test isolation voltage	2.5 kV		4 kV
Mounting method	DIN-rail mountable TH35 or G32 (EN 60715)		
Temperature range	-20...+50 °C		

Dimension drawing

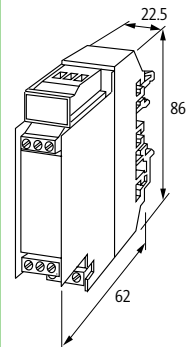
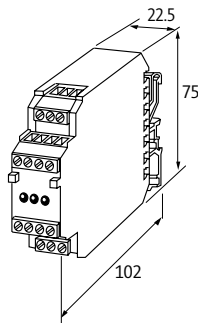

Notes

RELAYS / SAFETY RELAYS

Relays

– Screw terminals

RM

Output relay
3 relays; each 1 NO/NC contact



RM

Output relay
4 relays; each 1 NO contact

Circuit diagram

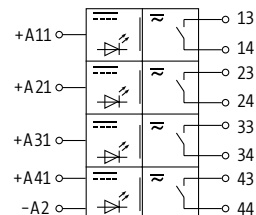
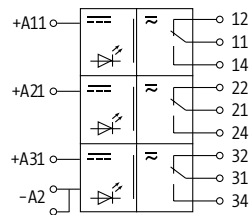

Order Data

24 V DC (19.2...30 V DC) - 16 mA

Art-No.

51403

Art-No.

512498

Utilization category

AC-1 8 A (24/110/230 V AC)
AC-15 3 A (24/110/230 V AC)
DC-13 1.5 A (24 V DC); 0.3 A (110 V DC); 0.15 A (230 V DC)

5 A (24/110/230 V AC)

Input

LED display LED (red)

Output

Switching voltage max. 250 V AC/DC
Switching current per output max. 8 A max. 5 A
Min. load current 100 mA
Power rating (voltage dependent) max. 1 250 VA/240 W
Switching frequency max. 0.1 Hz (with load)
Contact material Ag Sn O2 Ag hv
Energize/release/contact bounce time 10/10/2 ms

General data

Mech./ elect. life 20 000 000 switching cycles/load dependent 50 000 000 switching cycles/load dependent
Test isolation voltage 4 kV
Mounting method DIN-rail mountable TH35 or G32 (EN 60715)
Temperature range -20...+50 °C

Dimension drawing

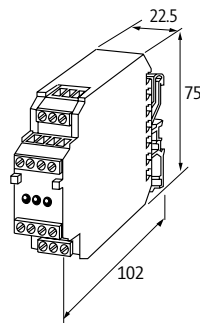

Notes

RELAYS / SAFETY RELAYS

Safety relay

– Protection-door and emergency-stop control

Approvals:  Listed

MIRO SAFE+ Switch H 48-230

with/without start button monitoring



Circuit diagram

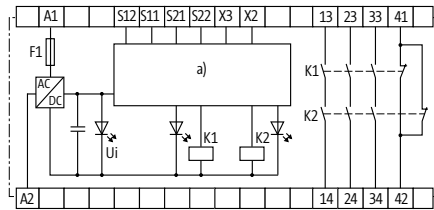

Order Data	Art-No.
3 safety contacts	3000-33113-1020012
Utilization category	
Safety contacts (STOPO)	max. 250 V AC/6 A; min. 10 V AC/10 mA (ohm./ind.), at suitable suppression
AC-15	6 A (230 V AC) STOPO
DC-13	6 A (24 V DC) STOPO
Safety Indicators	
PL	up to e
Category	up to 4
DC	99%
SIL	up to 3
Service life	20 years
Input	
Input voltage	48...240 V AC
Input current	max. 2.8 VA
Output	
Switching voltage	max. 250 V AC/DC
Switching current per output	max. 6 A
Number of auxiliary contacts	1 - (41-42)
Number of alarm outputs	0
Number of safety contacts	3 - (13-14); (23-24); (33-34)
Contact material	AgSnO, self cleaning, positively driven
General data	
Mech./ elect. life	10 000 000 switching cycles/load dependent
Connection	Spring clamp plug-in terminals
Mounting method	DIN-rail mountable (EN 60715)
Temperature range	-25...+45 °C (storage temperature -40...+85 °C)
Dimension drawing	

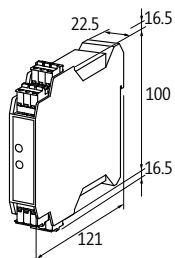

Notes

RELAYS / SAFETY RELAYS

Safety relay

- Protection-door and emergency-stop control
- Light curtain control
- Safety magnetic switch control

Approvals:  

MIRO SAFE+ Switch H L 24

with/without start button monitoring



Circuit diagram

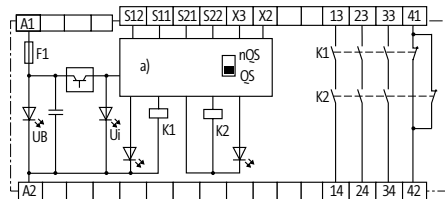

Order Data

3 safety contacts

Art-No.

3000-33113-3020012

Utilization category

Safety contacts (STOPO)

max. 250 V AC/8 A; min. 10 V AC/10 mA (ohm./ind.), at suitable suppression

AC-15

6 A (230 V AC) STOPO

DC-13

6 A (24 V DC) STOPO

Safety Indicators

PL

up to e

Category

up to 4

DC

99%

SIL

up to 3

Service life

20 years

Input

Input voltage

24 V DC (-15 +20%), 24 V AC (-15 +10%)

Input current

max. 4.9 VA/2.0 W

Output

Switching voltage

max. 250 V AC/DC

Switching current per output

max. 8 A

Total current

24 A (45 °C); 18 A (55 °C); 12 A (60 °C)

Number of auxiliary contacts

1 - (41-42)

Number of alarm outputs

0

Number of safety contacts

3 - (13-14); (23-24); (33-34)

Contact material

AgSnO, self cleaning, positively driven

General data

Mech./ elect. life

10 000 000 switching cycles/load dependent

Connection

Spring clamp plug-in terminals

Mounting method

DIN-rail mountable (EN 60715)

Temperature range

-25...+60 °C (storage temperature -40...+85 °C)

Dimension drawing

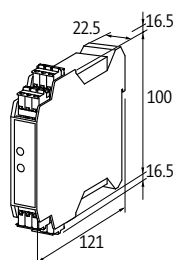

Notes

RELAYS / SAFETY RELAYS

Safety relay

- Protection-door and emergency-stop control
- Light curtain control
- Safety magnetic switch control

MIRO SAFE+ Switch ECOA 24

without start button monitoring



Circuit diagram

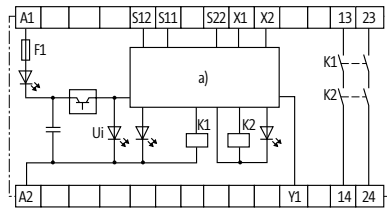

Order Data		Art-No.
2 safety contacts		3000-33113-3020005
Utilization category		
Safety contacts (STOP 0)	max. 250 V AC/4 A; min. 5 V AC/1 mA (ohm./ind.), at suitable suppression	
AC-15	2 A (230 V AC) STOPO	
DC-13	1 A (24 V DC) STOPO	
Alarm outputs	100 mA (24 V DC)	
Safety Indicators		
PL	up to 4	
Category	–	
DC	–	
SIL	–	
Service life	–	
Input		
Input voltage	24 V DC (-15 +20%), 24 V AC (-15 +10%)	
Input current	max. 5.2 VA/2.0 W	
Output		
Switching voltage	max. 250 V AC/DC	
Switching current per output	max. 4 A	
Number of auxiliary contacts	0	
Number of alarm outputs	1 - (Y1)	
Number of safety contacts	2 - (13-14; 23-24)	
Contact material	AgSnO, self cleaning, positively driven	
General data		
Mech./ elect. life	10 000 000 switching cycles/load dependent	
Connection	Screw terminals	
Mounting method	DIN-rail mountable (EN 60715)	
Temperature range	-25...+60 °C (storage temperature -40...+85 °C)	
Dimension drawing		

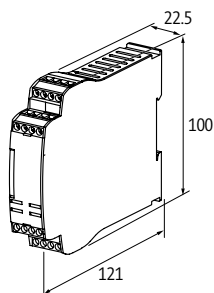

Notes

RELAYS / SAFETY RELAYS

Safety relay

- Protection-door and emergency-stop control
- Light curtain control
- Safety magnetic switch control

Approvals:  UL[®] Listed

MIRO SAFE+ Switch BA L 24

without start button monitoring



MIRO SAFE+ Switch BCS L 24

with start button monitoring



Circuit diagram

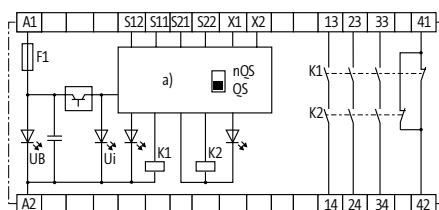

Order Data	Art-No.	Art-No.
3 safety contacts	3000-33113-3020025	3000-33113-3020020
Utilization category		
Safety contacts (STOPO)	max. 250 V AC/8 A; min. 10 V AC/10 mA (ohm./ind.), at suitable suppression	
AC-15	6 A (230 V AC) STOPO	
DC-13	6 A (24 V DC) STOPO	
Safety Indicators		
PL	up to e	
Category	up to 4	
DC	99%	
SIL	up to 3	
Service life	20 years	
Input		
Input voltage	24 V DC (-15 +20%), 24 V AC (-15 +10%)	
Input current	max. 4.9 VA/2.0 W	max. 4.4 VA/1.8 W
Output		
Switching voltage	max. 250 V AC/DC	
Switching current per output	max. 8 A	
Total current	24 A (45 °C); 18 A (55 °C); 12 A (60 °C)	
Number of auxiliary contacts	1 - (41-42)	
Number of alarm outputs	0	
Number of safety contacts	3 - (13-14); (23-24); (33-34)	
Contact material	AgSnO, self cleaning, positively driven	
General data		
Mech./ elect. life	10 000 000 switching cycles/load dependent	
Connection	Screw terminals	
Mounting method	DIN-rail mountable (EN 60715)	
Temperature range	-25...+60 °C (storage temperature -40...+85 °C)	

Dimension drawing

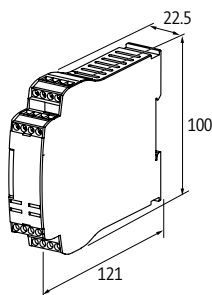

Notes

RELAYS / SAFETY RELAYS

Safety relay

- Protection-door and emergency-stop control
- Light curtain control
- Safety magnetic switch control

Approvals:  Listed

MIRO SAFE+ T 1 24

with/without start button monitoring



MIRO SAFE+ T 2 24

with/without start button monitoring



Circuit diagram

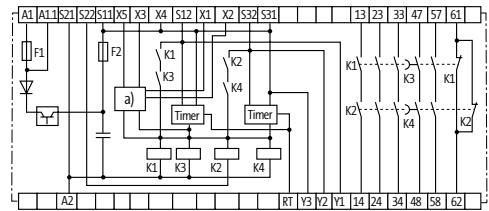
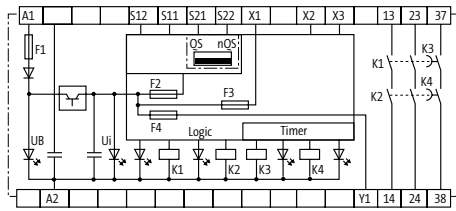

Order Data	Art-No.	Art-No.
3 safety contacts	3000-33113-3020065	
5 safety contacts		3000-33113-3020060
Utilization category		
Safety contacts (STOP 0)	max. 250 V AC/8 A; min. 5 V AC/5 mA (ohm./ind.), at suitable suppression	max. 250 V AC/8 A; min. 10 V AC/10 mA (ohm./ind.), at suitable suppression
Safety contacts (STOP 1)	max. 250 V AC/6 A; min. 10 V AC/10 mA (ohm./ind.), at suitable suppression	
AC-15	6 A (230 V AC) STOPO; 3 A (230 V AC) STOP1	
DC-13	5 A (24 V DC) STOPO; 2 A (24 V DC) STOP1	6 A (24 V DC) STOPO; 2 A (24 V DC) STOP1
Safety Indicators		
PL	up to e (STOPO); up to d (STOP1)	
Category	up to 4 (STOPO); up to 3 (STOP1)	
DC	99% (STOPO); min. 60% (STOP1)	
SIL	up to 3 (STOPO); up to 2 (STOP1)	
Service life	20 years	
Input		
Input voltage	24 V DC (-15 +20%), 24 V AC (-15 +10%)	
Input current	5.9 VA/2.4 W (with monitoring output)	max. 7.1 VA/3.2 W (with monitoring output)
Output		
Switching voltage	max. 250 V AC/DC	
Switching current per output	max. 8 A (STOPO); max. 6 A (STOP1)	max. 6 A
Number of auxiliary contacts	0	1 - (31-32)
Total current (STOP 0)	–	18 A (45 °C); 15 A (55 °C); 12 A (60 °C)
Number of alarm outputs	1 - (Y1)	3 - (13-14); (23-24); (33-34)
Total current (STOP 1)	–	12 A (45 °C); 10 A (55 °C); 8 A (60 °C)
Number of safety contacts	2 - (13-14), (23-24), STOPO; 1 - (37-38), STOP1	3 - (13-14), (23-24), (33-34), STOPO; 2 - (47-48), (57-58), STOP1
Contact material	AgSnO, self cleaning, positively driven	
General data		
Mech./ elect. life	10 000 000 switching cycles/load dependent	
Connection	Spring clamp plug-in terminals	
Mounting method	DIN-rail mountable (EN 60715)	
Temperature range	-25...+60 °C (storage temperature -40...+85 °C)	
Dimension drawing		

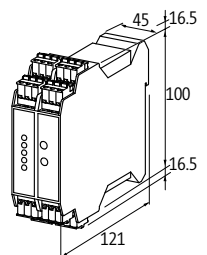
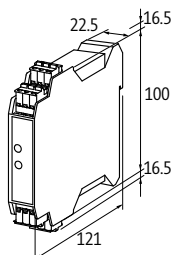

RELAYS / SAFETY RELAYS

Safety relay

– Two hand control

MIRO SAFE+ HAND 24

without start button monitoring



Approvals:  **UL** us
Listed

Circuit diagram

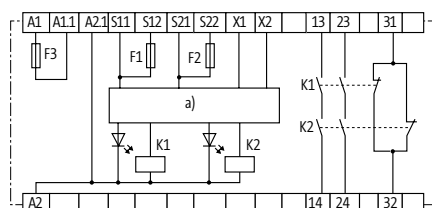

Order Data

2 safety contacts

Art-No.

3000-33113-3020030

Utilization category

Safety contacts (STOPO)

max. 250 V AC/6 A; min. 10 V AC/10 mA (ohm./ind.), at suitable suppression

AC-15

6 A (230 V AC) STOPO

DC-13

6 A (24 V DC) STOPO

Safety Indicators

PL

up to e

Category

up to 4

DC

99%

SIL

up to 3

Service life

20 years

Input

Input voltage

24 V DC $\pm 10\%$

Input current

max. 1.2 W

Output

Switching voltage

max. 250 V AC/DC

Switching current per output

max. 6 A

Number of auxiliary contacts

1 - (31-32)

Number of alarm outputs

0

Number of safety contacts

2 - (13-14); (23-24)

Contact material

AgSnO, self cleaning, positively driven

General data

Mech./ elect. life

10 000 000 switching cycles/load dependent

Connection

Spring clamp plug-in terminals

Mounting method

DIN-rail mountable (EN 60715)

Temperature range

-25...+60 °C (storage temperature -40...+85 °C)

Dimension drawing

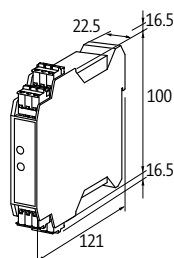

Notes

RELAYS / SAFETY RELAYS

Safety relay

- Protection-door control
- Pressure-sensitive mat. control

Approvals:  Listed

MIRO SAFE+ STEP 24

without start button monitoring



Circuit diagram

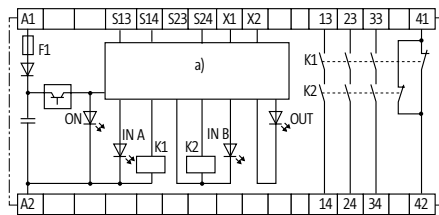

Order Data		Art-No.
3 safety contacts		3000-33113-3020050
Utilization category		
Safety contacts (STOPO)	max. 250 V AC/8 A; min. 10 V AC/10 mA (ohm./ind.), at suitable suppression	
AC-15	6 A (230 V AC) STOPO	
DC-13	6 A (24 V DC) STOPO	
Safety Indicators		
PL	up to e	
Category	up to 4	
DC	99%	
SIL	up to 3	
Service life	20 years	
Input		
Input voltage	24 V DC (-15 +20%), 24 V AC (-15 +10%)	
Input current	max. 3.7 VA/1.6 W (24 V DC)	
Output		
Switching voltage	max. 250 V AC/DC	
Switching current per output	max. 8 A	
Number of auxiliary contacts	1 - (41-42)	
Number of alarm outputs	0	
Number of safety contacts	3 - (13-14); (23-24); (33-34)	
Contact material	AgSnO, self cleaning, positively driven	
General data		
Mech./ elect. life	10 000 000 switching cycles/load dependent	
Connection	Spring clamp plug-in terminals	
Mounting method	DIN-rail mountable (EN 60715)	
Temperature range	-25...+60 °C (storage temperature -40...+85 °C)	
Dimension drawing		

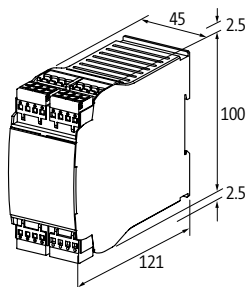

Notes

RELAYS / SAFETY RELAYS

Expansion modules

MIRO SAFE+ E 24

Expansion module



Approvals:  **UL** ^{us}
Listed

Circuit diagram

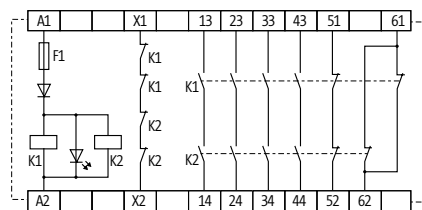

Order Data

4 NO contacts

Art-No.

3000-33113-3020075

Utilization category

Safety contacts (STOP 0)

max. 250 V AC/6 A; min. 10 V AC/10 mA (ohm./ind.), at suitable suppression

AC-15

6 A (230 V AC)

DC-13

6 A (24 V DC)

Safety Indicators

PL

up to e

Category

up to 4

SIL

up to 3

Service life

20 years

Input

Input voltage

24 V DC (-15 +20%), 24 V AC (-15 +10%)

Input current

max. 1.0 VA

Output

Switching voltage

max. 250 V AC/DC

Switching current per output

max. 6 A

Number of auxiliary contacts

2 - (51-52); (61-62)

Number of alarm outputs

0

Number of contacts

4 - (13-14); (23-24); (33-34); (43-44)

Contact material

AgSnO, self cleaning, positively driven

General data

Mech./ elect. life

10 000 000 switching cycles/load dependent

Connection

Spring clamp plug-in terminals

Mounting method

DIN-rail mountable (EN 60715)

Temperature range

-25...+45 °C (storage temperature -40...+85 °C)

Dimension drawing

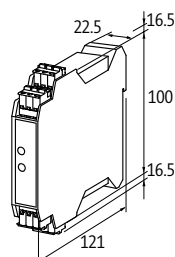

Notes

RELAYS / SAFETY RELAYS

Labeling accessories			Art-No.
	ACS label plate (KM 5) for self marking (9 × 20 mm) 5 × 10 mm		7000-99001-000000 90931
	Label plate (KWI 5/15) (88 pieces per plate)		90901
Wiring accessories			Art-No.
	Potential plug link max. 48 V/2 A	RMM..., RMMD...	90960
	Potential plug link max. 50 V/2 A	MIRO	90961
	Potential plug link blue	MIRO 6.2 pluggable	3000-90000-0300010
	Potential plug link black	MIRO 6.2 pluggable	3000-90000-0300020
	Potential rail blue 10-pole, spacing 6.2 mm 40-pole, spacing 12 mm	MIRO 6.2 (screw terminals) RMM..., RMMD...	90975 90970
	Potential rail red 10-pole, spacing 6.2 mm 40-pole, spacing 12 mm	MIRO 6.2 (screw terminals) RMM..., RMMD...	90976 90971
	End caps for potential rail blue	MIRO 6.2 RMM..., RMMD...	90980
	End caps for potential rail red	MIRO 6.2 RMM..., RMMD...	90982

RELAYS / SAFETY RELAYS

Wiring accessories			Art-No.
	Wire chain 16-pole Connection cable left and right approx. 50 cm; bk; 1 mm ²	MIRO (spring clamp terminals)	90977
	Double spring clamp terminal pluggable	MIRO SAFE+	3000-33010-0000000



OPTOCOUPERS / SEMICONDUCTORS SWITCHING WITHOUT WEAR

- Shortest possible switching times
- High switching frequencies
- Resistant to EMC interference

MILLIONS OF SWITCHING CYCLES – EVEN WITH HIGH FREQUENCIES

Optocouplers and semiconductors are used to combine different signal levels or to isolate one signal from another. They are similar to a relay interface because they provide an optoelectronic signal transfer between input and output.

Optocouplers and semiconductors have a long life span because they don't have any mechanical components that could wear out. They are suitable for applications with high switching frequencies, even over a long time.

Some benefits of optocouplers and semiconductors:

- Silent operation
- No contact bounce
- Galvanic separation between input and output
- High resistance to shock and vibration
- High switching currents
- Low input power

Optocouplers / Semiconductors



Optocouplers

- Pluggable
- DC applications

Page 1.10.1



Optocouplers

- DC applications

Page 1.10.2



Semiconductors

- AC applications

Page 1.10.18

Terminal optocoupler

- pluggable
- with bridge system
- Complete module

MIRO 6.2

Transistor 6 A
Spring clamp terminals



Circuit diagram

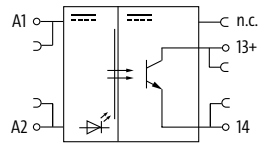

Order Data

24 V DC (18...30 V DC) - 9 mA

Art-No.

3000-32512-2100040

Accessories

Removable plug-in module

Art-No.

3000-32522-2100040

Input

Connection voltage - current 24 V DC (18...30 V DC) - 9 mA

LED display LED (yellow)

Output

Switching time ON/OFF 15/31 μ s

Switching voltage 3...30 V DC

Switching current per output 10 mA...6 A

Saturation voltage (across output) max. 240 mV

Switching frequency max. 500/50 Hz (ohm./ind.)

General data

Test isolation voltage 50 V

Surge voltage resistance 2.5 kV

Protection IP20

Mounting method pluggable

Temperature range -25...+50 °C

Dimension drawing

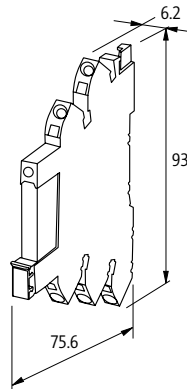

Notes

OPTOCOUPLEDERS / SEMICONDUCTORS

Terminal optocoupler
– with bridge system

MIRO 6.2
 Transistor 1 A
 Screw terminals



MIRO 6.2
 Transistor 1 A
 Spring clamp terminals



MIRO 6.2
 Transistor 2 A
 Screw terminals



MIRO 6.2
 Transistor 2 A
 Spring clamp terminals



Circuit diagram

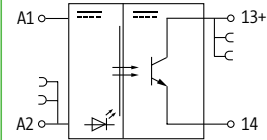
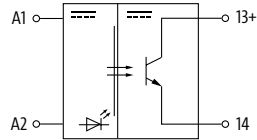

Order Data	Art-No.	Art-No.	Art-No.	Art-No.
24 V DC/6 mA	52515	6652515		
5 V DC/6 mA			cURus, cCSAus	6652502
Input				
Voltage range ON	11...30 V DC		4...5.5 V DC	
Voltage range OFF	0...5 V DC		0...2 V DC	
Control current	6 mA			
LED display	LED (yellow)			
Output				
Switching voltage	3...48 V DC		5...48 V DC	
Switching current per output	500 µA...1 A		1 mA...2 A	
Saturation voltage (across output)	max. 0.12 V DC		max. 0.3 V DC	
Leakage current (output is open)	max. 25 µA		max. 10 µA	
Switching time ON/OFF	1.5/1 ms (100 mA load)		1/5 ms	
Switching frequency	max. 40/4 Hz (resist./ind.)		max. 10/1 Hz (resist./ind.)	
General data				
Test isolation voltage	500 V		2.5 kV	
Mounting method	DIN-rail mountable (EN 60715)			
Housing	Black plastic, flame retardant			
Temperature range	-20...+60 °C			

Dimension drawing

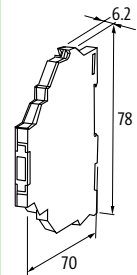
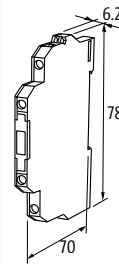
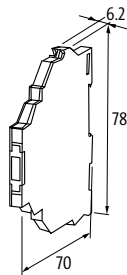
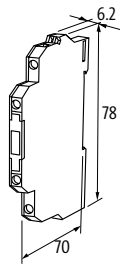

Notes

OPTOCOUPLEDERS / SEMICONDUCTORS

Terminal optocoupler

– with bridge system

MIRO 6.2

Transistor 2 A
Screw terminals



MIRO 6.2

Transistor 2 A
Spring clamp terminals



MIRO 6.2

Transistor 0.5 A
Screw terminals



MIRO 6.2

Transistor 0.5 A
Spring clamp terminals



Approvals:

Circuit diagram

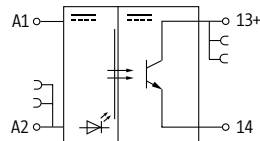

Order Data	Art-No.	Art-No.	Art-No.	Art-No.
24 V DC/6 mA	52501	6652501		
48 V DC/6 mA			52505	6652505

Input		
Voltage range ON	10...48 V DC	18...56 V DC
Voltage range OFF	0...5 V DC	0...12 V DC
Control current	6 mA	
LED display	LED (yellow)	
Output		
Switching voltage	5...48 V DC	
Switching current per output	1 mA...2 A	0.1 mA...0.5 A
Saturation voltage (across output)	max. 0.3 V DC	max. 1.2 V DC
Leakage current (output is open)	max. 10 µA	
Switching time ON/OFF	1/5 ms	20/100 µs
Switching frequency	max. 10/1 Hz (resist./ind.)	max. 1 kHz/10 Hz (resist./ind.)
General data		
Test isolation voltage	2.5 kV	3.75 kV
Mounting method	DIN-rail mountable (EN 60715)	
Housing	Black plastic, flame retardant	
Temperature range	-20...+60 °C	

Dimension drawing				

Notes				

OPTOCOUPLEDERS / SEMICONDUCTORS

Terminal optocoupler
– with bridge system

MIRO 6.2
Transistor 6 A
Screw terminals



MIRO 6.2
Transistor 6 A
Spring clamp terminals



MIRO 6.2
Transistor 10 A
Screw terminals



MIRO 6.2
Transistor 10 A
Spring clamp terminals



Approvals: 

Circuit diagram

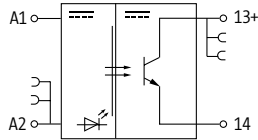

Order Data	Art-No.	Art-No.	Art-No.	Art-No.
24 V DC/6 mA	cURus	52519	6652519	
24 V DC/10 mA			cURus	52520
				6652520

Input		
Voltage range ON	10...53 V DC	
Voltage range OFF	0...5 V DC	
Control current	approx. 10 mA	10 mA
LED display	LED (yellow)	
Output		
Switching voltage	5...48 V DC	
Switching current per output	1 mA...6 A (without derating)	1 mA...10 A
Saturation voltage (across output)	max. 0.1 V DC	max. 0.12 V DC
Leakage current (output is open)	max. 25 µA	
Switching time ON/OFF	2/5 ms	2/5 ms (10 A load)
Switching frequency	max. 1/0.1 Hz (resist./ind.)	
General data		
Test isolation voltage	2.75 kV	
Mounting method	DIN-rail mountable (EN 60715)	
Housing	Black plastic, flame retardant	
Temperature range	-20...+60 °C	

Dimension drawing

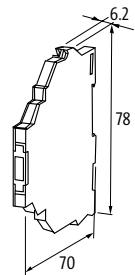
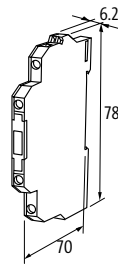
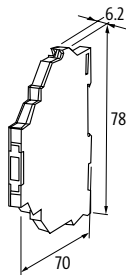
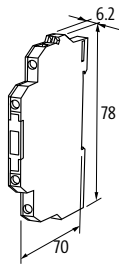

Notes

OPTOCOUPLEDERS / SEMICONDUCTORS

Terminal optocoupler

– with bridge system

Approvals:  

MIRO 6.2

Transistor 10 A
Screw terminals



MIRO 6.2

Transistor 10 A
Spring clamp terminals



MIRO 6.2

Transistor 0.5 A
Screw terminals



MIRO 6.2

Transistor 0.5 A
Spring clamp terminals



Circuit diagram

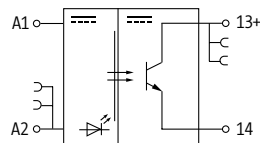

Order Data

24 V DC/10 mA (pulse control operation)

Art-No.

52521

Art-No.

6652521

Art-No.

52500

Art-No.

6652500

24 V DC/6 mA

Input

Voltage range ON

10...53 V DC

Voltage range OFF

0...5 V DC

Control current

10 mA

6 mA

LED display

LED (yellow)

Output

Switching voltage

5...48 V DC

Switching current per output

1 mA...10 A, short-circuit and overload protected (pulse switching)

0.1 mA...0.5 A

Saturation voltage (across output)

max. 0.12 V DC

max. 1.2 V DC

Leakage current (output is open)

max. 25 μ A

max. 10 μ A

Switching time ON/OFF

2/5 ms (10 A load)

35/400 μ s

Switching frequency

max. 1/0.1 Hz (resist./ind.)

max. 1000/100 Hz (resist./ind.)

General data

Test isolation voltage

2.75 kV

3.75 kV

Mounting method

DIN-rail mountable (EN 60715)

Housing

Black plastic, flame retardant

Temperature range

-20...+60 °C

Dimension drawing

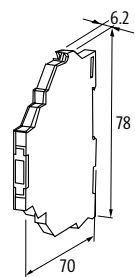
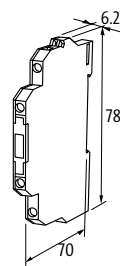
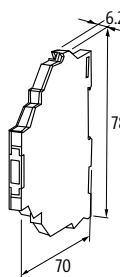
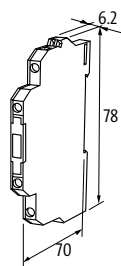

Notes

OPTOCOUPLEDERS / SEMICONDUCTORS

Terminal optocoupler

– with bridge system

Approvals:  

MIRO 6.2

Transistor 0.5 A
Screw terminals



MIRO 6.2

Transistor 0.5 A
Spring clamp terminals



MIRO 6.2

Transistor 0.5 A
Screw terminals



MIRO 6.2

Transistor 0.5 A
Spring clamp terminals



Circuit diagram

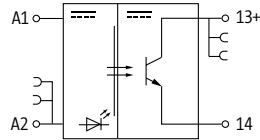

Order Data	Art-No.	Art-No.	Art-No.	Art-No.
110 V AC/DC - 6 mA	52506	6652506		
230 V AC - 6 mA			52507	6652507

Input		
Voltage range ON	70...130 V AC/DC	90...250 V AC
Voltage range OFF	0...30 V AC/DC	0...40 V AC
Control current	6 mA	7 mA
LED display	LED (yellow)	
Output		
Switching voltage	5...48 V DC	
Switching current per output	0.1 mA...0.5 A	
Saturation voltage (across output)	max. 1.2 V DC	
Leakage current (output is open)	max. 0.3 mA	
Switching time ON/OFF	100/700 µs	55/15 ms
Switching frequency	max. 500/30 Hz (resist./ind.)	
General data		
Test isolation voltage	3.75 kV	
Mounting method	DIN-rail mountable (EN 60715)	
Housing	Black plastic, flame retardant	
Temperature range	-20...+60 °C	

Dimension drawing

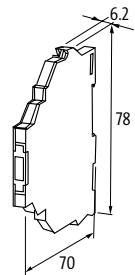
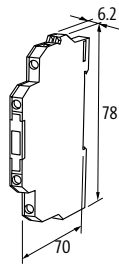
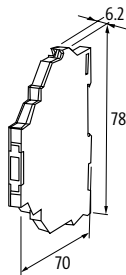
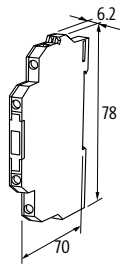

Notes

Terminal optocoupler

– with bridge system

Approvals:

MIRO 6.2

Transistor 2 A
Screw terminals



MIRO 6.2

Transistor 2 A
Spring clamp terminals



Circuit diagram

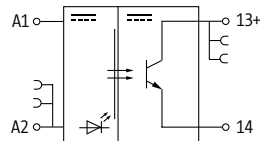

Order Data

230 V AC - 6 mA

Art-No.

52508

Art-No.

6652508

Input

Voltage range ON 90...250 V AC

Voltage range OFF 0...30 V AC

Control current 15 mA

LED display LED (yellow)

Output

Switching time ON/OFF 3/10 ms

Switching voltage 5...48 V DC

Switching current per output 1 mA...2 A (without derating)

Saturation voltage (across output) max. 0.3 V DC

Leakage current (output is open) max. 0.3 mA

Switching frequency max. 10/1 Hz (resist./ind.)

General data

Test isolation voltage 2.5 kV

Mounting method DIN-rail mountable (EN 60715)

Housing Black plastic, flame retardant

Temperature range -20...+60 °C

Dimension drawing

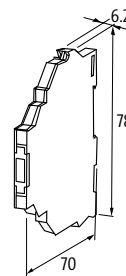
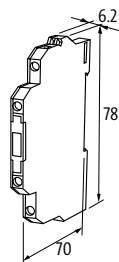

Notes

OPTOCOUPLEDERS / SEMICONDUCTORS

Terminal optocoupler

– with bridge system

Approvals:  

MIRO 6.2

Transistor 2 A
Inrush current limiting
Screw terminals



MIRO 6.2

Transistor 2 A
Inrush current limiting
Spring clamp terminals



MIRO 6.2

Transistor 0.5 A
electr. NO/NC contact
Screw terminals



MIRO 6.2

Transistor 0.5 A
electr. NO/NC contact
Spring clamp terminals



Circuit diagram

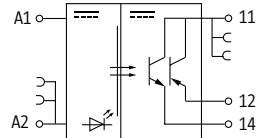
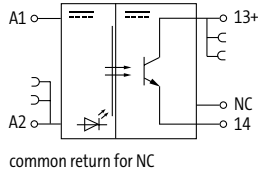

Order Data	Art-No.	Art-No.	Art-No.	Art-No.
24 V DC/6 mA	52512	6652512	52510	6652510
Input				
Voltage range ON	10...53 V DC			
Voltage range OFF	0...5 V DC			
Control current	6 mA			
LED display	LED (yellow)			
Output				
Switching voltage	5...48 V DC			
Switching current per output	1 mA...2 A (overload protected)		0.1 mA...0.5 A	
Saturation voltage (across output)	max. 0.35 V DC		max. 1.2 V DC	
Leakage current (output is open)	max. 0.1 mA			
Switching time ON/OFF	5/10 ms		40/150 µs	
Switching frequency	max. 10 Hz			
General data				
Test isolation voltage	2.5 kV		3.75 kV	
Housing	Black plastic, flame retardant			
Mounting method	DIN-rail mountable (EN 60715)			
Temperature range	-20...+60 °C			
Dimension drawing				

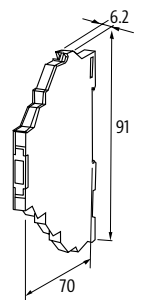
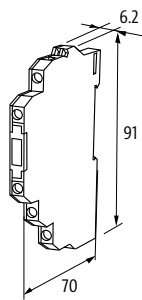
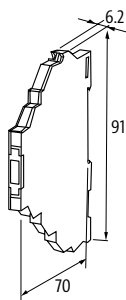
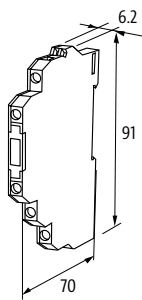

Notes

Terminal optocoupler

– with bridge system

MIRO 6.2

Transistor 0.2 A
Control current 0.1 mA (5 V DC)
Screw terminals



MIRO 6.2

Transistor 0.2 A
Control current 0.1 mA (5 V DC)
Spring clamp terminals



MIRO 6.2

Transistor 2 A
short-circuit protected
Screw terminals



MIRO 6.2

Transistor 2 A
short-circuit protected
Spring clamp terminals



Approvals: us

Circuit diagram

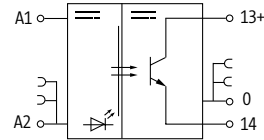
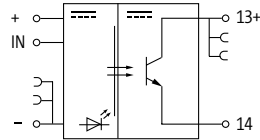

Order Data

24 V DC/0.1 mA (5 V DC)

cCSAus

Art-No.

52511

cCSAus

Art-No.

6652511

Art-No.

52503

Art-No.

6652503

24 V DC/6 mA

Input

Voltage range ON

15...30 V DC

Voltage range OFF

0...2 V DC

Control current

0.1 mA (5 V)

LED display

LED (yellow)

Output

Switching voltage

5...48 V DC

Switching current per output

0.1 mA...0.2 A

Saturation voltage (across output)

max. 1.2 V DC

Leakage current (output is open)

max. 0.1 mA

Switching frequency

max. 20 kHz

Switching time ON/OFF

10/18 µs

General data

Test isolation voltage

3.75 kV

Mounting method

DIN-rail mountable (EN 60715)

Housing

Black plastic, flame retardant

Temperature range

-20...+60 °C

Dimension drawing

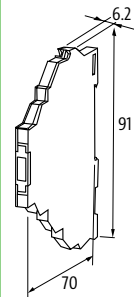
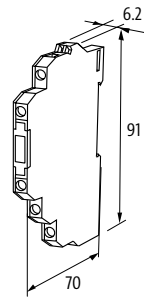
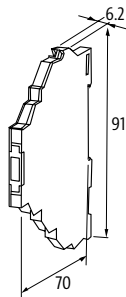
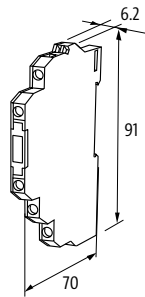

Notes

OPTOCOUPLEDERS / SEMICONDUCTORS

Terminal optocoupler

– with bridge system

MIRO 6.2

Transistor 1 A
Multi voltage output
Screw terminals



MIRO 6.2

Transistor 1 A
Multi voltage output
Spring clamp terminals



MIRO 6.2

Transistor 0.2 A
Spring clamp terminals



MIRO 6.2

Transistor 0.1 A
Spring clamp terminals

Circuit diagram

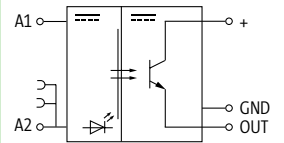
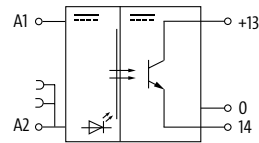
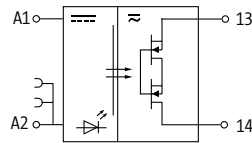

Order Data	Art-No.	Art-No.	Art-No.	Art-No.
24 V DC/10 mA	52572	6652572	UR, cCSAus	526071
Input				
Voltage range ON	10...53 V DC		10...35 V DC	10...30 V DC
Voltage range OFF	0...5 V DC			0...7 V DC
Control current	10 mA		6 mA	5.5 mA
LED display	LED (yellow)		LED (green)	LED (yellow)
Output				
Switching time ON/OFF	3/6 ms		5/7 μ s	0.4/0.1 μ s
Switching voltage	5...250 V AC/5...350 V DC		10...30 V DC	5...48 V DC
Switching current per output	1 mA...1 A		1 mA...0.2 A	0...0.1 A
Saturation voltage (across output)	max. 0.7 V AC/DC		max. 0.3 V AC/DC	max. 1.2 V AC/DC
Leakage current (output is open)	max. 25 μ A			max. 250 μ A
Switching frequency	max. 10 Hz		max. 20 kHz/200 Hz (resist./ind.)	500 kHz (ohmic)
General data				
Test isolation voltage	2.75 kV		2.5 kV	2.75 kV
Mounting method	DIN-rail mountable (EN 60715)			
Housing	Black plastic, flame retardant			
Temperature range	-20...+60 °C			
Dimension drawing				

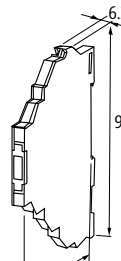
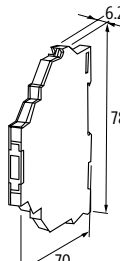
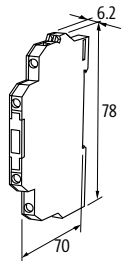

Notes

OPTOCOUPLEDERS / SEMICONDUCTORS

Terminal optocoupler

– Isolation function in output circuit

MIRO 6.2

Transistor 2 A
Screw terminals



MIRO 6.2

Transistor 2 A
Spring clamp terminals



Approvals:

Circuit diagram

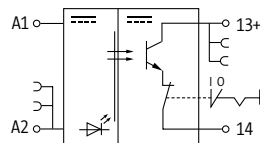

Order Data

24 V DC/7 mA

Art-No.

52513

Art-No.

6652513

Input

Voltage range ON 10...48 V DC

Voltage range OFF 0...5 V DC

Control current 7 mA

LED display LED (yellow)

Output

Switching time ON/OFF 1/5 ms

Switching voltage 5...48 V DC

Switching current per output 1 mA...2 A

Saturation voltage (across output) max. 0.3 V DC

Leakage current (output is open) max. 0.3 mA

Switching frequency max. 10/1 Hz (resist./ind.)

General data

Housing Black plastic, flame retardant

Test isolation voltage 2.5 kV

Mounting method DIN-rail mountable (EN 60715)

Temperature range -20...+60 °C

Dimension drawing

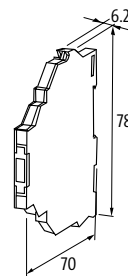
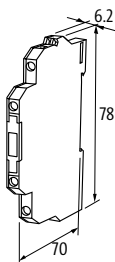

Notes

OPTOCOUPLEDERS / SEMICONDUCTORS

Optocouplers

- Inrush current limiting
- Screw terminals

AMMS

Transistor 1.2 A



EMMS

Transistor 1.2 A

Circuit diagram

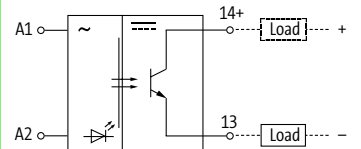
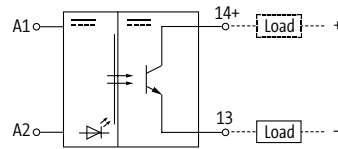
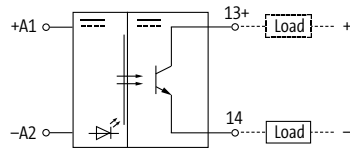

Order Data	Art-No.	Art-No.	Art-No.
3.5...5.5 V DC/6 mA	50041		
24 V DC/6 mA		50040	
110/230 V AC/2.7 mA			50105
Input			
Voltage range ON	3.5...5.5 V DC	10...53 V DC	100...253 V AC
Voltage range OFF	0...0.8 V DC	0...3 V DC	0...40 V AC
Input current	6 mA		2.7 mA
LED display	LED (red)		
Output			
Leakage current (output is open)	max. 0.3 mA		
Switching current per output	1 mA...1.2 A		
Switching voltage	4.5...53 V DC		
Saturation voltage (across output)	max. 1.2 V DC		
Switching time ON/OFF	100/700 μ s		20/50 ms
Switching frequency	max. 500 Hz (resist.) at max. 0.2 A/max. 30 Hz (ind.)		max. 5 Hz
General data			
Test isolation voltage	3.75 kV		
Mounting method	DIN-rail mountable TH35 or G32 (EN 60715)		
Housing	Black plastic, flame retardant		
Temperature range	-20...+60 °C		

Dimension drawing

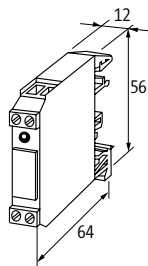

Notes

Optocouplers

- Inrush current limiting
- Screw terminals

AMMS

Transistor 0.5 A



AMMS

Transistor 2 A

Circuit diagram

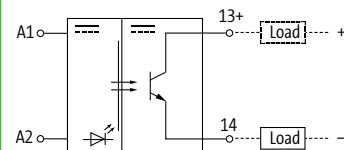
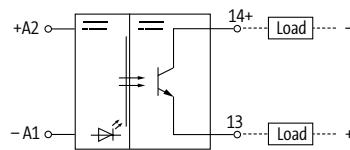

Order Data

4...30 V DC/10 mA
24 V DC/6 mA

Art-No.
50010

Art-No.

50070

Input

Voltage range ON 4...30 V DC
Voltage range OFF 0...2 V DC
Input current max. 10 mA
LED display LED (red)

10...53 V DC
0...3 V DC
6 mA

Output

Switching voltage 4.5...44 V DC
Switching current per output 1 mA...0.5 A
Saturation voltage (across output) max. 1.2 V DC
Leakage current (output is open) max. 0.3 mA
Switching time ON/OFF 65 μ s/20 ms
Switching frequency max. 7 kHz (resist.) at max. 0.1 A/max. 10 Hz (ind.)

4.5...40 V DC
10 mA...2 A
max. 0.1 V DC
max. 0.1 mA
2/8 ms
max. 20/5 Hz (resist./ind.)

General data

Test isolation voltage 3.75 kV
Mounting method DIN-rail mountable TH35 or G32 (EN 60715)
Housing Black plastic, flame retardant
Temperature range -20...+60 °C

2.5 kV

Dimension drawing

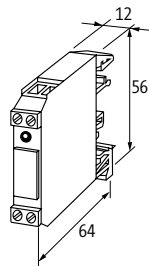

Notes

OPTOCOUPLEDERS / SEMICONDUCTORS

Optocouplers

– Double terminals on the output side

– Screw terminals

AMMDS

Transistor 0.1 A
with minus plug link



AMMDS

Transistor 2 A
with minus plug link

AMMDS

Transistor 0.1 A

Circuit diagram

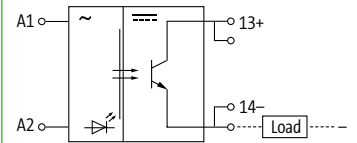
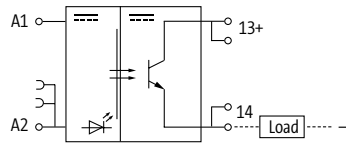

Order Data	Art-No.	Art-No.	Art-No.
24 V DC/6 mA	50081	50080	
230 V AC - 10 mA			50110

Input			
LED display	LED (red)		
Input current	6 mA		7.5 mA
Plug link (supplied)	Art.-No. 90960		–
Voltage range ON	10...53 V DC		195...253 V AC
Voltage range OFF	0...3 V DC		0...110 V AC
Output			
Switching voltage	4...40 V DC	4...35 V DC	4...40 V DC
Switching current per output	1 mA...0.1 A	10 mA...2 A (short-circuit protected)	1 mA...0.1 A
Saturation voltage (across output)	max. 1.2 V DC	max. 0.5 V DC	max. 1.2 V DC
Leakage current (output is open)	max. 0.3 mA		
Switching time ON/OFF	1.5/2 ms	5/15 ms	50/120 ms
Switching frequency	max. 300/40 Hz (resist./ind.)	max. 10/1 Hz (resist./ind.)	
General data			
Mounting method	DIN-rail mountable TH35 or G32 (EN 60715)		
Housing	Black plastic, flame retardant		
Temperature range	-20...+60 °C		
Test isolation voltage	3.75 kV	2.5 kV	3.75 kV

Dimension drawing

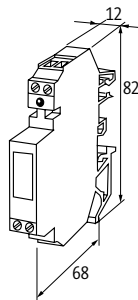

Notes

OPTOCOUPLEDERS / SEMICONDUCTORS

Optocouplers

– with minus plug link

– Screw terminals

AMMDS

Transistor 0.2 A
Double terminals on the output side
for rapid switching



AMMDS

Transistor 1 A

Circuit diagram

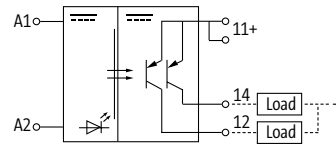
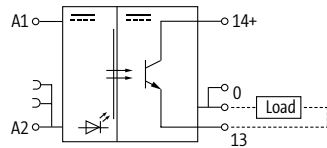

Order Data

24 V DC/15 mA

Art-No.

50082

Art-No.

24 V AC/DC - 10 mA

50085

Input

Voltage range ON

10...35 V DC

Voltage range OFF

0...5 V DC

Input current

10 mA

LED display

LED (red)

Plug link (supplied)

Art.-No. 90960

Output

Switching voltage

5...35 V DC

Switching current per output

1 mA...0.2 A

Saturation voltage (across output)

max. 0.5 V DC

Leakage current (output is open)

max. 0.3 mA

Switching time ON/OFF

20/14 μ s

Switching frequency

max. 20 kHz/200 Hz (resist./ind.)

General data

Test isolation voltage

2.5 kV

Mounting method

DIN-rail mountable TH35 or G32 (EN 60715)

Housing

Black plastic, flame retardant

Temperature range

-20...+60 °C

Dimension drawing

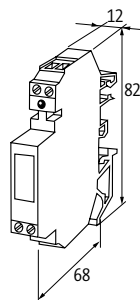

Notes

OPTOCOUPLEDERS / SEMICONDUCTORS

Power opto-coupler modules

– Screw terminals

AMS

Transistor 4 A



AMS

Transistor 2 A (3-way)
3 NO contacts



AMS

Transistor 2 A (4-way)
4 NO contacts



Circuit diagram

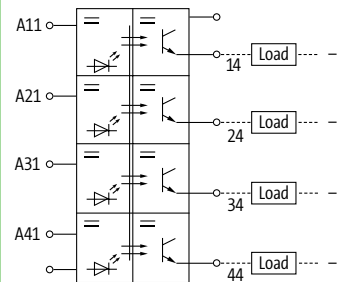
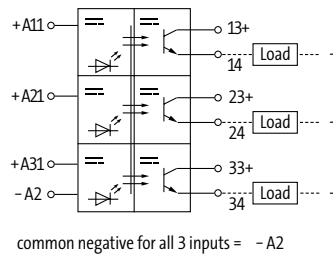
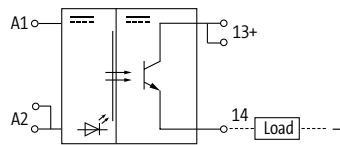

Order Data	Art-No.	Art-No.	Art-No.
24 V DC/10 mA	50044	50043	
24 V DC/3 mA			cCSAus 50015
Input			
Voltage range ON	10...53 V DC		20...30 V DC
Voltage range OFF	0...3 V DC		0...6 V DC
Input current	14.5 mA	10 mA	27 mA
LED display	LED (red)		LED (yellow)
Output			
Switching voltage	4.5...53 V DC	4.5...35 V DC	5...30 V DC
Switching current per output	10 mA...4 A	10 mA...2 A (short-circuit protected)	1 mA...2 A
Saturation voltage (across output)	max. 1.5 V DC	max. 0.5 V DC	max. 0.05 V DC
Switching time ON/OFF	4/7 μs	2/15 ms	1/5 ms
Leakage current (output is open)	–	max. 0.3 mA	max. 0.01 mA
Switching frequency	max. 2 kHz/4 Hz (resist./ind.)	max. 10/1 Hz (resist./ind.)	
General data			
Test isolation voltage	3.75 kV	2.5 kV	
Mounting method	DIN-rail mountable TH35 or G32 (EN 60715)		
Housing	Black plastic, flame retardant		
Temperature range	-20...+60 °C		-25...+50 °C

Dimension drawing

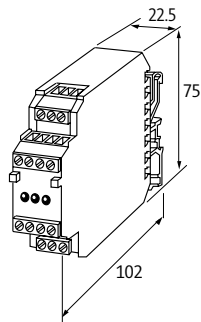

Notes

OPTOCOUPLEDERS / SEMICONDUCTORS

Optocouplers

- DC Motor control
- Over current / temperature monitoring

MIRO 12.4

Transistor 3 A
Screw terminals



MIRO 12.4

Transistor 3 A
Spring clamp terminals



Circuit diagram

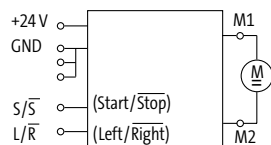

Order Data

24 V DC/10 mA

Art-No.

50140

Art-No.

6650140

Input

Voltage range ON	15...30 V DC
Voltage range OFF	0...5 V DC
Input current	10 mA
LED display	LED (yellow): right running; LED (green): left running

Output

Switching voltage	19.2...30 V DC
Switching current per output	max. 3 A
Highest current	approx. 6 A for 100 ms
Saturation voltage (across output)	max. 1.4 V DC
Leakage current (output is open)	max. 10 mA
Switching time ON/OFF	1.2/10 ms
Switching frequency	max. 1 Hz (motor dependant)
Changing time	max. 50 ms
LED display	LED (red): error (over current/over heated)

General data

Test isolation voltage	no galvanic separation
Mounting method	DIN-rail mountable TH35 or G32 (EN 60715)
Housing	Black plastic, flame retardant
Temperature range	0...+50 °C

Dimension drawing

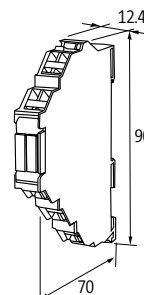
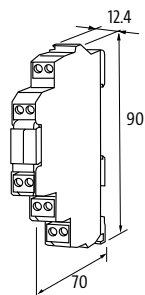

Notes

OPTOCOUPLEDERS / SEMICONDUCTORS

Terminal triac

– Zero potential switch

Approvals:  

MIRO 6.2

Triac 0.5 A
Screw terminals



MIRO 6.2

Triac 0.5 A
Spring clamp terminals



MIRO 6.2

Triac 0.5 A
Screw terminals



MIRO 6.2

Triac 0.5 A
Spring clamp terminals



Circuit diagram

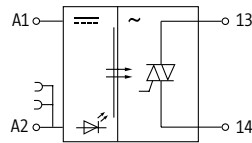

Order Data	Art-No.	Art-No.	Art-No.	Art-No.
5 V DC/6 mA	52551	6652551		
24 V DC/6 mA			52550	6652550

Input		
Voltage range ON	4...5.5 V DC	10...53 V DC
Voltage range OFF	0...2 V DC	0...5 V DC
Control current	6 mA	
LED display	LED (yellow)	
Output		
Switching voltage	24...250 V AC	
Switching current per output	2 mA...0.5 A	1.5 mA...0.5 A
Saturation voltage (across output)	max. 1.5 V AC	
Leakage current (output is open)	max. 0.3 mA	
Switching time ON/OFF	10/10 ms	
Switching frequency	max. 20 Hz, depending on suppression	
General data		
Test isolation voltage	2.5 kV	
Mounting method	DIN-rail mountable (EN 60715)	
Housing	Black plastic, flame retardant	
Temperature range	-20...+60 °C	

Dimension drawing

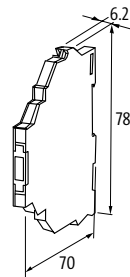
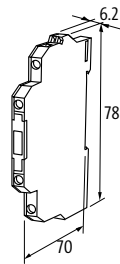
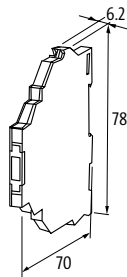
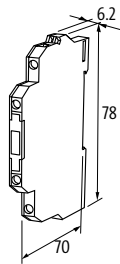

Notes

Terminal triac

– Zero potential switch

MIRO 6.2

Triac 1 A
Screw terminals



MIRO 6.2

Triac 1 A
Spring clamp terminals



Circuit diagram

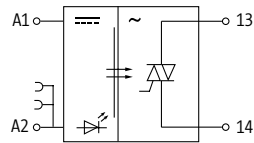

Order Data

24 V DC/9 mA

Art-No.

52571

Art-No.

6652571

Input

Voltage range ON	12...53 V DC
Voltage range OFF	0...3 V DC
Control current	12 mA (24 V DC)
LED display	LED (yellow)

Output

Switching voltage	12...250 V AC
Switching current per output	10 mA...1 A
Saturation voltage (across output)	max. 1.5 V AC
Leakage current (output is open)	max. 1 mA
Switching time ON/OFF	10/10 ms
Switching frequency	max. 2 Hz, depending on suppression

General data

Test isolation voltage	2.5 kV
Mounting method	DIN-rail mountable (EN 60715)
Housing	Black plastic, flame retardant
Temperature range	0...+60 °C

Dimension drawing

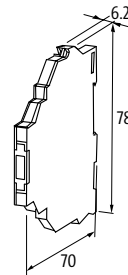
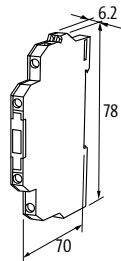

Notes

OPTOCOUPLEDERS / SEMICONDUCTORS

Terminal triac

– Zero potential switch

Approvals:  

MIRO 6.2

Triac 0.5 A
Screw terminals



MIRO 6.2

Triac 0.5 A
Spring clamp terminals



MIRO 6.2

Triac 0.5 A
Screw terminals



MIRO 6.2

Triac 0.5 A
Spring clamp terminals



Circuit diagram

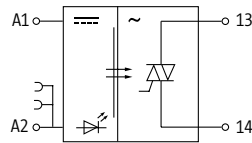

Order Data	Art-No.	Art-No.	Art-No.	Art-No.
110 V AC/DC (95...121 V AC/DC) - 3.5 mA	52556	6652556		
230 V AC - 7 mA			52557	6652557

Input		
Voltage range ON	70...130 V AC/DC	140...250 V AC
Voltage range OFF	0...35 V AC/DC	0...80 V AC
Control current	3.5 mA	7 mA
LED display	LED (yellow)	

Output		
Switching voltage	12...250 V AC	
Switching current per output	2 mA...0.5 A	
Saturation voltage (across output)	max. 1.5 V AC	
Leakage current (output is open)	max. 0.3 A	max. 0.3 mA
Switching time ON/OFF	10/10 ms	
Switching frequency	max. 20 Hz, depending on suppression	

General data	
Test isolation voltage	2.5 kV
Mounting method	DIN-rail mountable (EN 60715)
Housing	Black plastic, flame retardant
Temperature range	-20...+60 °C

Dimension drawing

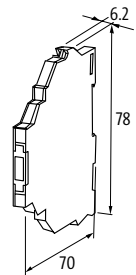
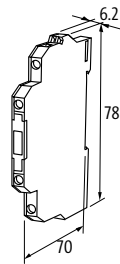
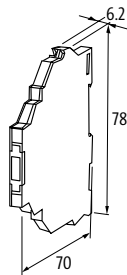
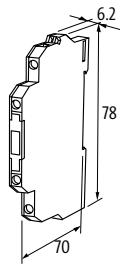

Notes

Terminal triac

– Zero potential switch

MIRO 6.2

Triac 0.5 A
Screw terminals



MIRO 6.2

Triac 0.5 A
Spring clamp terminals



Circuit diagram

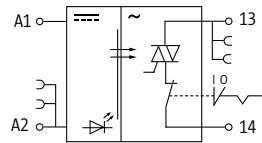

Order Data

24 V DC/7 mA

Art-No.

52561

Art-No.

6652561

Input

Voltage range ON 10...53 V DC

Voltage range OFF 0...5 V DC

Control current 7 mA

LED display LED (yellow)

Output

Switching voltage 24...250 V AC

Switching current per output 2 mA...0.5 A

Saturation voltage (across output) max. 1.5 V AC

Leakage current (output is open) max. 0.3 mA

Switching time ON/OFF 10/10 ms

Switching frequency max. 20/1 Hz (resist./ind.)

General data

Test isolation voltage 2.5 kV

Mounting method DIN-rail mountable (EN 60715)

Housing Black plastic, flame retardant

Temperature range -20...+60 °C

Dimension drawing

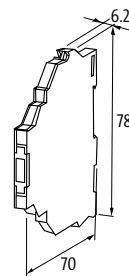
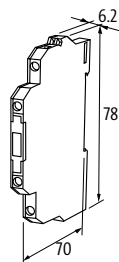

Notes

OPTOCOUPLEDERS / SEMICONDUCTORS

Triac modules

- Zero potential switch
- Screw terminals

AMS

Triac 4 A



Circuit diagram

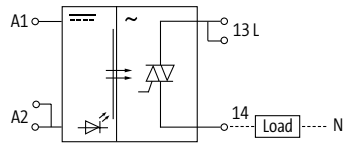

Order Data	Art-No.
24 V DC/10 mA	50034

Input	
Voltage range ON	10...53 V DC
Voltage range OFF	0...3 V DC
Input current	10 mA
LED display	LED (red)
Output	
Switching voltage	24...250 V AC
Switching current per output	10 mA...4 A
Saturation voltage (across output)	max. 1.4 V AC
Leakage current (output is open)	max. 10 mA
Switching time ON/OFF	10/10 ms
Switching frequency	max. 30/5 Hz (resist./ind.)
General data	
Test isolation voltage	6 kV
Mounting method	DIN-rail mountable TH35 or G32 (EN 60715)
Housing	Black plastic, flame retardant
Temperature range	-20...+60 °C

Dimension drawing

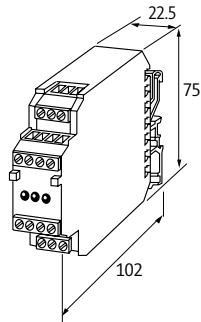

Notes

OPTOCOUPPLERS / SEMICONDUCTORS

Triac modules

– Zero potential switch

– Screw terminals

AMMS

Triac 1 A



AMMDS

Triac 2 A
with minus plug link



Circuit diagram

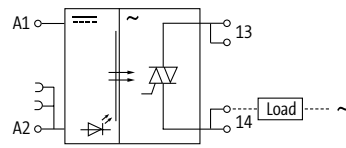
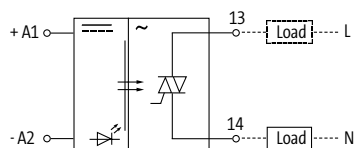

Order Data

24 V DC/6.6 mA

Art-No.

50030

Art-No.

24 V DC/6 mA

50092

Input

Voltage range ON

10...53 V DC

10...35 V DC

Voltage range OFF

0...3 V DC

Input current

6.6 mA

6 mA

LED display

LED (red)

Plug link (supplied)

–

Art-No. 90960

Output

Switching voltage

24...253 V AC

24...280 V AC

Switching current per output

50 mA...1 A

50 mA...2 A

Saturation voltage (across output)

max. 1.3 V AC

max. 1 V AC

Leakage current (output is open)

max. 5 mA

max. 2 mA

Switching time ON/OFF

10/10 ms

Switching frequency

max. 20 Hz

max. 20/5 Hz (resist./ind.)

General data

Test isolation voltage

2.5 kV

Mounting method

DIN-rail mountable TH35 or G32 (EN 60715)

Housing

Black plastic, flame retardant

Temperature range

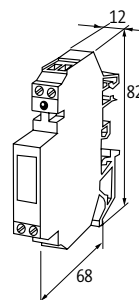
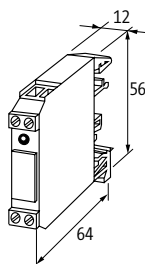

-20...+60 °C

Dimension drawing



Notes

OPTOCOUPERS / SEMICONDUCTORS

Labeling accessories			Art-No.
	ACS label plate (KM 5) for self marking (9 × 20 mm)		7000-99001-000000
	Label plate (KM 4) 5 × 10 mm		90931
	ACS label plate (KM 6/18) for self marking with ADEMARK markers		7000-99003-000000
	Label plate (KWI 5/15) (88 pieces per plate)		90901
Wiring accessories			Art-No.
	Potential plug link max. 50 V/2 A	MIRO	90961
	Potential plug link max. 48 V/2 A	RMM..., RMDM...	90960
	Potential rail blue 40-pole, spacing 12 mm	RMM..., RMDM...	90970
	10-pole, spacing 6.2 mm	MIRO 6.2 (screw terminals)	90975
	Potential rail red 40-pole, spacing 12 mm	RMM..., RMDM...	90971
	10-pole, spacing 6.2 mm	MIRO 6.2 (screw terminals)	90976
	End caps for potential rail blue	MIRO 6.2 RMM..., RMDM...	90980
	red	MIRO 6.2 RMM..., RMDM...	90982

Wiring accessories			Art-No.
	<p>Wire chain 16-pole Connection cable left and right approx. 50 cm; bk; 1 mm²</p>	<p>MIRO (spring clamp terminals)</p>	<p>90977</p>



SWITCHES

PERFECT CROSS-LINKING FOR YOUR APPLICATION

- Reduces the installation effort
- Switches for the control cabinet IP20, IP50, and the field IP67
- Compact and robust design

FROM SOLID BASIC FUNCTIONS TO AN ENORMOUS FUNCTIONAL VARIETY

Murrelektronik offers a broad portfolio of switches. Unmanaged switches are used to reliably cover basic functions at an advantageous price-performance ratio. Lite-managed switches offer a large scope of functions and variants such as the PROFINET managed switches are tailored perfectly to the possibilities of PROFINET environments.

- Optimization of wiring flexibility and reduction of the complexity of installation solutions
- Easy insights into the communication and uncomplicated connection to network analysis tools or integrated web servers
- Relocation of the coupling level to the field creating space in the control cabinet by using compact and robust IP67 variants

Unmanaged Switches



Unmanaged Switches

- IP20
- IP50
- IP67

Page 1.11.1

Managed Switches



Lite-Managed Switches

- IP20
- IP67

Page 1.11.4



PROFINET-Managed Switches

- IP20
- IP67



Page 1.11.6

SWITCHES

Unmanaged Switch

TREE 4TX Metal

IP50



TREE 8TX Metal

IP50



TREE 6TX Eco

IP20



TREE 8TX Metal

IP50



Approvals:  UL Listed

Order Data	Art-No.	Art-No.	Art-No.	Art-No.
4 ports	58151			
8 ports		58152		58171
6 ports			58170	
Connections				
Fieldbus	4 × RJ45	8 × RJ45	6 × RJ45	8 × RJ45
Supply	Spring clamp plug-in terminal: 0.2...2.5 mm ²		Screw plug-in terminal: 0.2...1.5 mm ²	
Technical Data				
Operating voltage	2 × 9...48 V DC, redundancy		2 × 9...30 V DC, redundancy	2 × 9...48 V DC, redundancy
Transfer rate	10/100 Mbit/s full duplex			
Operating modes	Autocrossing Autonegotiation			
Switch Management				
Switch Form	Unmanaged Switch			
Webserver	no			
VLAN (QoS) IEEE 802.p	yes			
Port Mirroring	no			
Protocols	no			
Remote maintenance	no			
Alarm contact	no			
Diagnostic				
Communication status	via LED			
Monitoring - no voltage	yes			
General data				
Protection	IP50		IP20	IP50
Housing	Metal black		Black plastic	Metal black
Mounting method	DIN-rail mountable TH35 (EN 60715)			
Temperature range	-10...+70 °C (storage temperature -40...+85 °C)		0...+60 °C (storage temperature -10...+70 °C)	-10...+70 °C (storage temperature -40...+85 °C)

Dimension drawing

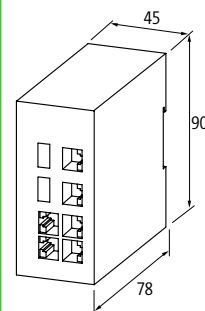
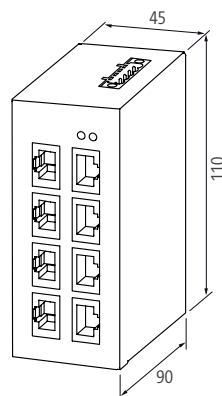
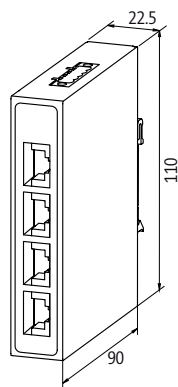

Notes

SWITCHES

Unmanaged Switch

TREE 6TX Metal

IP50



TREE 8TX Metal

8 ports Gigabit
IP50



Approvals:  Listed

Order Data	Art-No.	Art-No.
6 ports	58172	
8 ports Gigabit		58173
Connections		
Fieldbus	6 × RJ45	8 × RJ45
Supply	Screw plug-in terminal: 0.2...1.5 mm ²	
Technical Data		
Operating voltage	2 × 9...30 V DC, redundancy	2 × 9...48 V DC, redundancy
Transfer rate	10/100 Mbit/s full duplex	10/100/1 000 Mbit/s full duplex
Operating modes	Autocrossing Autonegotiation	
Switch Management		
Switch Form	Unmanaged Switch	
Websserver	no	
VLAN (QoS) IEEE 802.p	yes	
Port Mirroring	no	
Protocols	no	
Remote maintenance	no	
Alarm contact	no	
Diagnostic		
Communication status	via LED	
Monitoring - no voltage	yes	
General data		
Protection	IP50	
Housing	Metal black	
Mounting method	DIN-rail mountable TH35 (EN 60715)	
Temperature range	-10...+70 °C (storage temperature -40...+85 °C)	
Dimension drawing		

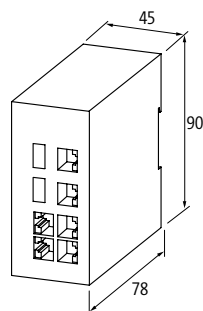

Notes

SWITCHES

Unmanaged Switch

TREE 4TX IP67 M12

4 × M12 (female), D-coded
IP67



TREE 8TX IP67 M12

8 × M12 (female), D-coded
IP67



Approvals:  **UL** us
Listed

Order Data	Art-No.	Art-No.
4 ports	58160	
8 ports		58161
Connections		
Fieldbus	4 × M12 (female), D-coded	8 × M12 (female), D-coded
Supply	1 × M12 (male), A-coded	
Technical Data		
Operating voltage	2 × 18...30 V DC, redundancy	
Transfer rate	10/100 Mbit/s full duplex	
Operating modes	Autocrossing Autonegotiation	
Switch Management		
Switch Form	Unmanaged Switch	
Webserver	no	
VLAN (QoS) IEEE 802.p	yes	
Port Mirroring	no	
Protocols	no	
Remote maintenance	no	
Alarm contact	no	
Diagnostic		
Communication status	via LED	
Monitoring - no voltage	yes	
General data		
Protection	IP67	
Housing	Zinc die casting, matte nickel plated	
Mounting method	4 hole screw mounting	
Temperature range	-25...+60 °C (storage temperature -40...+80 °C)	
Dimension drawing		

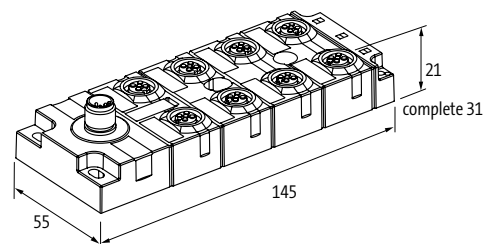
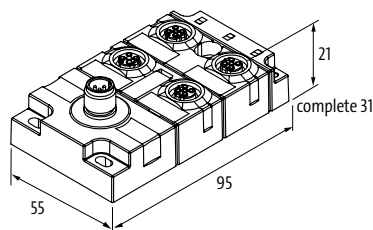

Notes

SWITCHES

Lite - Managed Switch

TREE M-4TX

IP20



TREE M-6TX

IP20



Order Data	Art-No.	Art-No.
4 ports	58181	
6 ports		58182
Connections		
Fieldbus	4 × RJ45	6 × RJ45
Supply	Spring clamp plug-in terminal: 0.2...2.5 mm ²	
Technical Data		
Operating voltage	9.5...31.5 V	
Transfer rate	10/100 Mbit/s full duplex	
Operating modes	Autocrossing Autonegotiation	
Switch Management		
Switch Form	Lite - Managed Switch	
Webserver	HTTP, HTTPS	
VLAN (QoS) IEEE 802.p	yes	
Port Mirroring	DHCP, SNMP (v1, v2c, v3), RSTP, STP	
Protocols	DHCP, SNMP (v1, v2c, v3), RSTP, STP, LLDP, NTP, RMON, SSH (CLI)	
Remote maintenance	Open VPN	
Alarm contact	no	yes
Diagnostic		
Communication status	via LED, LLDP	
Monitoring - no voltage	yes	
General data		
Protection	IP20	
Housing	Black plastic	
Mounting method	DIN-rail mountable (EN 50022)	
Temperature range	0...+60 °C (storage temperature -40...+85 °C)	
Dimension drawing		

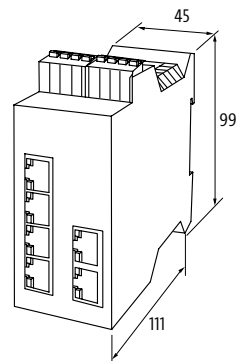
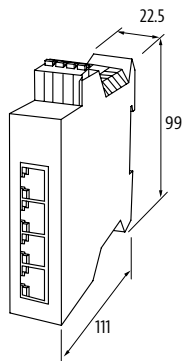

Notes

Lite - Managed Switch

TREE M-STX-PN IP67

IP67



Order Data		Art-No.
5 ports		58183
Connections		
Fieldbus	5 × M12 (female), D-coded	
Supply	1 × M12 (male), A-coded	
Technical Data		
Operating voltage	9.5...31.5 V	
Transfer rate	10/100 Mbit/s full duplex	
Operating modes	Autocrossing Autonegotiation	
Switch Management		
Switch Form	Lite - Managed Switch	
Websserver	HTTP, HTTPS	
VLAN (QoS) IEEE 802.p	yes	
Port Mirroring	yes	
Protocols	DHCP, SNMP (v1, v2c, v3), RSTP, STP, LLDP, NTP, RMON, SSH (CLI)	
Remote maintenance	Open VPN	
Alarm contact	no	
Diagnostic		
Communication status	via LED, LLDP	
Monitoring - no voltage	yes	
General data		
Protection	IP67	
Housing	Black plastic	
Mounting method	3 hole screw mounting	
Temperature range	0...+60 °C (storage temperature -40...+85 °C)	
Dimension drawing		

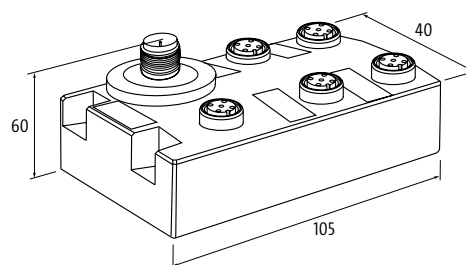

Notes	
--------------	--

SWITCHES

PROFINET - Managed Switch



TREE M-4TX

PROFINET - Managed Switch
IP20



TREE M-6TX

PROFINET - Managed Switch
IP20



Order Data	Art-No.	Art-No.
4 ports	58185	
6 ports		58186
Connections		
Fieldbus	4 × RJ45	6 × RJ45
Supply	Spring clamp plug-in terminal: 0.2...2.5 mm ²	
Technical Data		
Operating voltage	9.5...31.5 V	
Transfer rate	10/100 Mbit/s full duplex	
Operating modes	Autocrossing Autonegotiation	
Switch Management		
Switch Form	PROFINET - Managed Switch	
Webserver	HTTP, HTTPS	
VLAN (QoS) IEEE 802.p	yes	
Port Mirroring	yes	
Protocols	DHCP, SNMP (v1, v2c, v3), RSTP, STP, LLDP, NTP, RMON, SSH (CLI)	
Remote maintenance	Open VPN	
Alarm contact	no	yes
PROFINET		
Addressing	DCP	
FSU (Fast-Start-Up)	no	
Shared Device/Input	no	
Profinet Netload Class	I	
Specification	V2.3, Conformance Class B	
MRP	yes	
Diagnostic		
Communication status	via LED, LLDP	
Monitoring - no voltage	yes	
General data		
Protection	IP20	
Housing	Black plastic	
Mounting method	DIN-rail mountable (EN 50022)	
Temperature range	0...+60 °C (storage temperature -40...+85 °C)	
Dimension drawing		

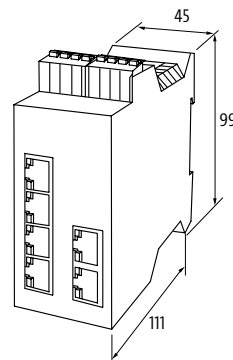
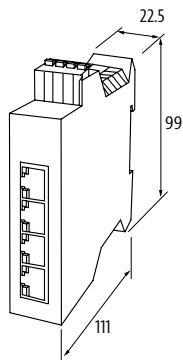

Notes

PROFINET - Managed Switch



TREE M-STX-PN IP67

PROFINET - Managed Switch
IP67



Order Data		Art-No.
5 ports		58184
Connections		
Fieldbus	5 × M12 (female), D-coded	
Supply	1 × M12 (male), A-coded	
Technical Data		
Operating voltage	9.5...31.5 V	
Transfer rate	10/100 Mbit/s full duplex	
Operating modes	Autocrossing Autonegotiation	
Switch Management		
Switch Form	PROFINET - Managed Switch	
Websverer	HTTP, HTTPS	
VLAN (QoS) IEEE 802.p	yes	
Port Mirroring	yes	
Protocols	DHCP, SNMP (v1, v2c, v3), RSTP, STP, LLDP, NTP, RMON, SSH (CLI)	
Remote maintenance	Open VPN	
Alarm contact	no	
PROFINET		
Addressing	DCP	
FSU (Fast-Start-Up)	no	
Shared Device/Input	no	
Profinet Netload Class	I	
Specification	V2.3, Conformance Class B	
MRP	yes	
Diagnostic		
Communication status	via LED, LLDP	
Monitoring - no voltage	yes	
General data		
Protection	IP67	
Housing	Black plastic	
Mounting method	3 hole screw mounting	
Temperature range	0...+60 °C (storage temperature -40...+85 °C)	

Dimension drawing

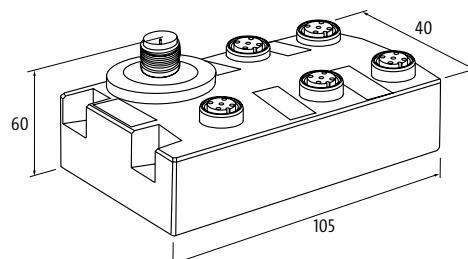

Notes

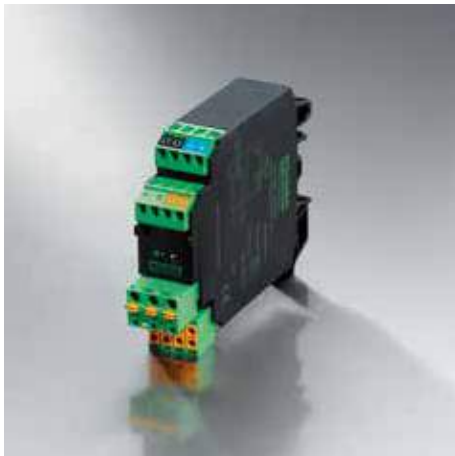

ACTIVE INTERFACE TECHNOLOGY

ANALOG AND DIGITAL

- Solid state or relay outputs are short circuit protected
- LED display
- DIN-rail mounting

CONVERT MEASURED VALUES INTO SIGNALS

While measuring, positioning or checking systems, the status of the machine or installation should be monitored. The measured values have to be converted into digital or standard signals (0...20 mA, 4...20 mA or 0...10V) so that PLCs and computers can process them.

Murrelektronik offers a wide range of intelligent interface modules that enable signal conversion or signal acquisition with galvanic separation.

Active Interface Technology



Converters

AD/DA converters, Analog converters,
Frequency converters, U/I converters

*An overview of this product range
can be found in our online shop*



Timer

MIRO 6.2 Timer

*An overview of this product range
can be found in our online shop*



Comparator modules

MAK

*An overview of this product range
can be found in our online shop*



Temperature converter

MTW

*An overview of this product range
can be found in our online shop*



Further

Brake rectifiers, Demagnetizer

*An overview of this product range
can be found in our online shop*



PASSIVE INTERFACE TECHNOLOGY INTERFACE MODULES

- Screw or spring clamp terminals
- LED displays
- DIN-rail mounting

FOR ANY APPLICATION

Murrelektronik's interface modules make the connections between the controls and the field.

They take over 3 major functions in the system:

- Signal transfer from the machine to the control
- Signal transfer inside the machine or control system
- Easy wiring in control systems

Murrelektronik has been an innovative partner in coming up with interface solutions for years. Their interface modules are fitted with different kinds of robust plugs like SUB-D connectors or ribbon cable connectors for strong signal or power transfers.

They are extremely compact. Individual terminal labels and status displays are integrated into the standard modules.

Interface Modules



With ribbon cable connection
UFL

An overview of this product range can be found in our online shop



With SUB-D connector
UG SUB, SV

An overview of this product range can be found in our online shop



With pluggable terminals
LUGS, PKB

An overview of this product range can be found in our online shop

EUROCARD HOLDERS / CONTROL MODULES

- Flexible applications
- Compact modules
- Connections with up to 96-poles

THE IDEAL CONTROL TECHNOLOGY FOR THE CABINET

Various electronic circuits are fitted onto 100×160 mm Eurocards and then placed in 19" system housings. Murrelektronik's Eurocard holders are designed to mount Eurocards on DIN rails in the cabinet.

In control systems, units are used which require analog control signals (i.e. 0...10 V DC). With these well designed MPOT potentiometer modules, it is simple, cheap and easy to solve your set-point problems. The diode modules of the MKS series are designed for decoupling and interference applications. The LED indicators are available with diameters of 3, 5, and 10 mm. With their compact design, they are suitable for installation in front panels or process flow diagrams.

Eurocard Holders



SKT

*An overview of this product range
can be found in our online shop*



SKP

*An overview of this product range
can be found in our online shop*

Control Modules



Potentiometer modules
MPOT

*An overview of this product range
can be found in our online shop*



Diode modules
MKS-D, MKS-LDP, MKS-BCD

*An overview of this product range
can be found in our online shop*



Assembly modules
MKS-M, ML 14, MP

*An overview of this product range
can be found in our online shop*



2

INTERFACES

2

INTERFACES

Front Panel Interfaces	2.1	
Control Cabinet Interfaces / Cable Entry Systems	2.2	
Hybrid Fieldbus Coupling	<i>An overview of this product range can be found in our online shop</i>	2.3
Lighting Elements	2.4	
Control Devices	2.5	
Modular Connection Systems (Modlink Vario)	2.6	
Heavy Duty Connectors (Modlink Heavy)	2.7	



MODLINK MSDD FRONT PANEL INTERFACES

- PLC Service Port
- IP65 Protection; UL Type Rating 4, 4x, 12, 13
- Modular Inserts

DESIGN YOUR OWN PART – WITH OUR ARTICLE NUMBERS

The article numbers help you figure out whether you are ordering outlets, data connector inserts, individual frames or sets. The article numbers of the individual components can be found on the following pages. Both modules and sets can be ordered in quantities of 1 or more.

THE SET

The set article number is made up of A, B, C and D.

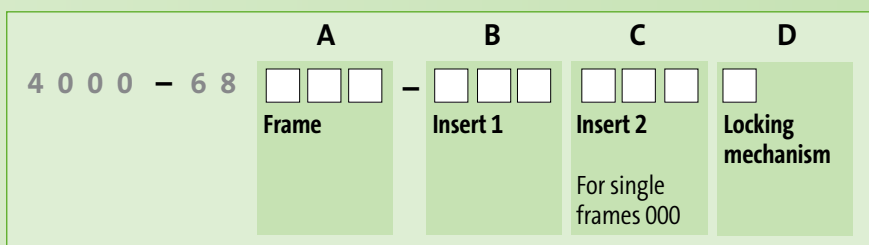

First select your components:

Block A: Frame (for example 4000-68**522**-000 0001 for transparent double frame)

Block B: Insert 1 (for example 4000-68000-**001** 0000 for Germany (VDE) gray)

Block C: Insert 2 (for example 4000-68000-**091** 0000 for 2× RJ45 + 2× USB)

Block D: Locking mechan. (for example 4000-68522-000 000**1** for 3 mm double-bit key)

The article number for this example set will be:

4 0 0 0 - 6 8 **5 2 2** - **0 0 1** **0 9 1** **1**

Modlink MSDD Front Panel Interfaces

Frames

- Single and double frames

Page 2.1.1

Inserts

- Power outlets
- Data connection inserts

Page 2.1.2

Built-in Sockets

- USB
- RJ45

Page 2.1.14







Modlink MSDD Front Panel Interfaces

An overview of this product range can be found in our online shop







FRONT PANEL INTERFACES

Frames (plastic)			Art-No.
	1-way transparent Mounting frame plastic, PA black Lid: plastic, PC transparent	cURus Closure: 3 mm double bit with attachable rotation knob	4000-68512-0000001
	Mounting frame plastic, PA black Lid: plastic, PC transparent	Closure: Daimler	4000-68512-0000003
	1-way metallic Mounting frame plastic, PA black Lid: plastic, ABS gray	cURus Closure: 3 mm double bit with attachable rotation knob	4000-68513-0000001
	Mounting frame plastic, PA black Lid: plastic, ABS gray	Closure: Daimler	4000-68513-0000003
	1-way gray Mounting frame plastic, PA black Lid: plastic, PBT gray	cURus Closure: 3 mm double bit with attachable rotation knob	4000-68514-0000001
	Mounting frame plastic, PA black Lid: plastic, PBT gray	Closure: Daimler	4000-68514-0000003
	2-way transparent Mounting frame plastic, PA black Lid: plastic, PC transparent	cURus Closure: 3 mm double bit with attachable rotation knob	4000-68522-0000001
	Mounting frame plastic, PA black Lid: plastic, PC transparent	Closure: Daimler	4000-68522-0000003
	2-way metallic Mounting frame plastic, PA black Lid: plastic, ABS gray	cURus Closure: 3 mm double bit with attachable rotation knob	4000-68523-0000001
	Mounting frame plastic, PA black Lid: plastic, ABS gray	Closure: Daimler	4000-68523-0000003
	2-way gray Mounting frame plastic, PA black Lid: plastic, PBT gray	cURus Closure: 3 mm double bit with attachable rotation knob	4000-68524-0000001
	Mounting frame plastic, PA black Lid: plastic, PBT gray	Closure: Daimler	4000-68524-0000003

FRONT PANEL INTERFACES

Power outlets			Art-No.
	<p>Germany (VDE) white Screw terminals: max. 6 mm² Operating voltage: 250 V AC Operating current: 16 A</p>	LED (yellow)	4000-68000-0010000
	<p>Germany (VDE) white Spring clamp terminals: max. 2.5 mm² (AWG 14) Operating voltage: 250 V AC Operating current: 16 A</p>		4000-68000-0160000
	<p>Germany (VDE) yellow Screw terminals: max. 6 mm² Operating voltage: 250 V AC Operating current: 16 A</p>		4000-68000-0020000
	<p>France (UTE-NF) gray Screw terminals: max. 6 mm² Operating voltage: 250 V AC Operating current: 16 A</p>	LED (yellow)	4000-68000-0050000
	<p>France (UTE-NF) white Screw terminals: max. 2 × 4 mm² (AWG 12) Operating voltage: 250 V AC Operating current: 16 A</p>		4000-68000-3010000
	<p>USA (NEMA 5-15) white Screw terminals: max. 2.5 mm² (AWG 14) Operating voltage: 125 V AC Operating current: 15 A</p>	cURus	4000-68000-3240000
	<p>USA (2 × NEMA-GFCI 5-15) Screw terminals: max. 2.5 mm² (AWG 14) Operating voltage: 125 V AC Operating current: 15 A</p>	cURus	4000-68000-3220000







FRONT PANEL INTERFACES

Power outlets			Art-No.
	<p>USA (2 × NEMA-GFCI 5-20) Screw terminals: max. 6 mm² Operating voltage: 125 V AC Operating current: max. 20 A per socket</p>	cURus	4000-68000-3280000
	<p>England (BS) Screw terminals: max. 4 mm² Operating voltage: 250 V AC Operating current: max. 13 A</p>	with touch protection	4000-68000-0060000
	<p>England (BS) orange Screw terminals: max. 4 mm² Operating voltage: 250 V AC Operating current: max. 13 A</p>		4000-68000-0190000
	<p>Italy (CEI 23-16) Screw terminals: max. 2.5 mm² (AWG 14) Operating voltage: 250 V AC Operating current: 16 A</p>	Double	4000-68000-0070000
	<p>Italy (CEI 23-16) Screw terminals: max. 2.5 mm² (AWG 14) Operating voltage: 250 V AC Operating current: 16 A</p>		4000-68000-0180000
	<p>Denmark Spring clamp terminals: max. 2.5 mm² (AWG 14) Operating voltage: 250 V AC Operating current: max. 10 A</p>		4000-68000-0170000
	<p>Swiss Spring clamp terminals: max. 1.5 mm² (AWG 16) Operating voltage: 250 V AC Operating current: max. 10 A</p>		4000-68000-0120000







FRONT PANEL INTERFACES

Power outlets			Art-No.
	<p>Australia Screw terminals: max. 2.5 mm² (AWG 14) Operating voltage: 250 V AC Operating current: max. 10 A</p>		4000-68000-0090000
	<p>India (IS 1293) Screw terminals: max. 4 mm² Operating voltage: 240 V AC Operating current: max. 5 A</p>		4000-68000-3210000
	<p>China (CCC) Screw terminals: max. 4 mm² Operating voltage: 250 V AC Operating current: max. 10 A</p>		4000-68000-3250000
	<p>Brazil Screw terminals: max. 2.5 mm² (AWG 14) Operating voltage: 250 V AC Operating current: max. 10 A</p>	Double	4000-68000-3290000
	<p>Brazil Screw terminals: max. 2.5 mm² (AWG 14) Operating voltage: 250 V AC Operating current: max. 10 A</p>	Single	4000-68000-3310000







FRONT PANEL INTERFACES

Communication inserts			Art-No.
	<p>SUB-D15 HD; RJ45; USB; USB (formA) 1 × SUB-D15 HD (female/male) VGA 1 × RJ45, 8-pole metal, CAT5e (female/female) 2 × USB (female/female) form A</p>	<p>cURus shielded</p>	<p>4000-68000-1040000</p>
	<p>RJ45; RJ45; USB (formA) 2 × RJ45, 8-pole metal, CAT5e (female/female) 1 × USB (female/female) form A</p>	<p>cURus shielded</p>	<p>4000-68000-0940000</p>
	<p>RJ45; USB (form A); DVI 1 × RJ45, 8-pole metal, CAT5e (female/female) 1 × USB (female/female) form A 1 × DVI (female/female)</p>		<p>4000-68000-0820000</p>
	<p>RJ45; RJ45; USB; USB (form A) 2 × RJ45, 8-pole metal, CAT5e (female/female) 2 × USB (female/female/0.7 m cable) form A</p>	<p>shielded</p>	<p>4000-68000-0990000</p>
	<p>RJ45; RJ12; USB; USB (form A) 1 × RJ45, 8-pole metal, CAT5e (female/female) 1 × RJ12, 6-pole plastic 2 × USB (female/female) form A</p>	<p>cURus shielded</p>	<p>4000-68000-0910000</p>
	<p>RJ45; USB; USB (form A) 1 × RJ45, 8-pole metal, CAT5e (female/female) 2 × USB (female/female) form A</p>	<p>shielded</p>	<p>4000-68000-0960000</p>
	<p>RJ45; RJ45; USB; USB (form A) 2 × RJ45, 8-pole metal, CAT5e (female/female) 2 × USB (female/female) form A</p>	<p>shielded</p>	<p>4000-68000-0970000</p>



FRONT PANEL INTERFACES







Communication inserts			Art-No.
	RJ45; SUB-D9; SUB-D9 1 × RJ45, 8-pole metal, CAT5e (female/female) 1 × SUB-D9 (female/female) 1 × SUB-D9 (male/male)	cURus	4000-68000-1110000
	RJ45; RJ45 2 × RJ45, 8-pole metal, CAT5e (female/female)	cURus shielded	4000-68000-1200000
	RJ45 1 × RJ45, 8-pole metal, CAT5e (female/female) 1 × SUB-D9 (blind plug)	cURus	4000-68000-1210000
	RJ45; RJ45; RJ45; RJ45 4 × RJ45, 8-pole metal, CAT5e (female/female)	shielded	4000-68000-1220000
	USB (form A); RJ45 1 × USB (female/female) form A 1 × RJ45, 8-pole metal, CAT5e (female/female)	cURus shielded	4000-68000-1310000
	RJ45; SUB-D9 1 × RJ45, 8-pole metal, CAT5e (female/female) 1 × SUB-D9 (female/female)	cURus shielded	4000-68000-1410000
	SUB-D9; RJ45; USB (form A) 1 × SUB-D9 (female/female) 1 × RJ45, 8-pole metal, CAT5e (female/female) 1 × USB (female/female/0.7 m cable) form A	shielded	4000-68000-1420000

FRONT PANEL INTERFACES







Communication inserts			Art-No.
	<p>RJ45; USB (form A); SUB-D9 1 × RJ45, 8-pole metal, CAT5e (female/female) 1 × USB (female/female) form A 1 × SUB-D9 (female/male)</p>	<p>cURus shielded</p>	<p>4000-68000-1430000</p>
	<p>RJ45; USB (form A); SUB-D9 1 × RJ45, 8-pole metal, CAT5e (female/female) 1 × USB (female/female) form A 1 × SUB-D9 (female/female)</p>	<p>cURus shielded</p>	<p>4000-68000-1440000</p>
	<p>RJ45; RJ45; SUB-D9 2 × RJ45, 8-pole metal, CAT5e (female/female) 1 × SUB-D9 (female/male)</p>	<p>shielded</p>	<p>4000-68000-1620000</p>
	<p>RJ45; SUB-D9; SUB-D25 1 × RJ45, 8-pole metal, CAT5e (female/female) 1 × SUB-D9 (female/male) 1 × SUB-D25 (female/male)</p>	<p>cURus</p>	<p>4000-68000-1700000</p>
	<p>BNC; RJ45; SUB-D9 1 × BNC (female/female) 1 × RJ45, 8-pole metal, CAT5e (female/female) 1 × SUB-D9 (female/male)</p>	<p>shielded</p>	<p>4000-68000-1800000</p>
	<p>BNC; RJ45; SUB-D9 1 × BNC (female/female) 1 × RJ45, 8-pole metal, CAT5e (female/female) 1 × SUB-D9 (female/female)</p>		<p>4000-68000-1810000</p>
	<p>USB (form A); SUB-D25; RJ45 1 × USB (female/female) form A 1 × SUB-D25 (female/male) 1 × RJ45, 8-pole metal, CAT5e (female/female)</p>	<p>cURus shielded</p>	<p>4000-68000-1450000</p>





FRONT PANEL INTERFACES

Communication inserts			Art-No.
	USB (form A); RJ45 1 × USB (female/female/0.7 m cable) form A 1 × RJ45, 8-pole metal, CAT5e (female/female)	shielded	4000-68000-1300000
	USB (form A); SUB-D9; RJ45 1 × USB (female/female/0.7 m cable) form A 1 × SUB-D9 (female/male) 1 × RJ45, 8-pole metal, CAT5e (female/female)	shielded	4000-68000-1400000
	USB; USB (form A) 2 × USB (female/female/0.7 m cable) form A	shielded	4000-68000-0900000
	USB (form A to A) 1 × USB (female/female) form A	cURus shielded	4000-68000-0920000
	USB (form A); USB (form A) 2 × USB (female/female) form A	cURus shielded	4000-68000-0930000
	USB; USB; USB; USB (form A) 4 × USB (female/female) form A		4000-68000-0950000
	USB (form A); DVI 2 × USB (female/female) form A 1 × DVI (female/female)		4000-68000-1280000







Combinations			Art-No.
	<p>Germany (VDE) 1 × Germany (VDE) white 2 × data cut-out</p>	<p>Spring clamp terminals: max. 2 × 2.5 mm² (AWG 14) Operating voltage: 250 V AC Operating current: 16 A shielded</p>	<p>4000-68000-4500000</p>
	<p>Germany (VDE) white; RJ45 1 × Germany (VDE) white 1 × RJ45, 8-pole metal, CAT6A (female/female) 1 × data cut-out</p>	<p>Spring clamp terminals: max. 2 × 2.5 mm² (AWG 14) Operating voltage: 250 V AC Operating current: 16 A shielded</p>	<p>4000-68000-4500001</p>
	<p>Germany (VDE) white; RJ45 1 × Germany (VDE) white 2 × RJ45, 8-pole metal, CAT6A (female/female)</p>	<p>Spring clamp terminals: max. 2 × 2.5 mm² (AWG 14) Operating voltage: 250 V AC Operating current: 16 A shielded</p>	<p>4000-68000-4500004</p>
	<p>Germany (VDE) orange; RJ45 1 × Germany (VDE) orange 1 × RJ45, 8-pole metal, CAT6A (female/female) 1 × data cut-out</p>	<p>Spring clamp terminals: max. 2 × 2.5 mm² (AWG 14) Operating voltage: 250 V AC Operating current: 16 A shielded</p>	<p>4000-68000-4620001</p>
	<p>France (UTE-NF); RJ45 1 × France (UTE-NF) white 1 × RJ45, 8-pole metal, CAT6A (female/female) 1 × data cut-out</p>	<p>Screw terminals: max. 2 × 4 mm² (AWG 12) Operating voltage: 250 V AC Operating current: 16 A shielded</p>	<p>4000-68000-4510001</p>
	<p>France (UTE-NF) 1 × France (UTE-NF) white 2 × data cut-out</p>	<p>Screw terminals: max. 2 × 4 mm² (AWG 12) Operating voltage: 250 V AC Operating current: 16 A shielded</p>	<p>4000-68000-4510000</p>
	<p>USA (NEMA 5-15); RJ45; USB (form A) 1 × NEMA 5-15 (plug-solder connection) 1 × RJ45, 8-pole metal, CAT5e (female/female) 1 × USB (female/female) form A</p>	<p>cURus</p>	<p>4000-68000-4030000</p>

FRONT PANEL INTERFACES









Combinations			Art-No.
	<p>USA (NEMA 5-15); RJ45 1 × NEMA 5-15 (plug-solder connection) 1 × RJ45, 8-pole metal, CAT5e (female/female)</p>	cURus	4000-68000-4040000
	<p>England (BS) 1 × Great Britain (BS) 2 × data cut-out</p>	Screw terminals: max. 2 × 4 mm ² (AWG 12) Operating voltage: 250 V AC Operating current: max. 13 A shielded	4000-68000-4520000
	<p>Great Britain (BS); RJ45 1 × Great Britain (BS) 1 × RJ45, 8-pole metal, CAT6A (female/female) 1 × data cut-out</p>	Screw terminals: max. 2 × 4 mm ² (AWG 12) Operating voltage: 250 V AC Operating current: max. 13 A shielded	4000-68000-4520001
	<p>Italy (CEI 23-16) 1 × Italy (CEI 23-16) 2 × data cut-out</p>	Screw terminals: max. 2 × 4 mm ² (AWG 12) Operating voltage: 250 V AC Operating current: 16 A shielded	4000-68000-4530000
	<p>Italy (CEI 23-16); RJ45 1 × Italy (CEI 23-16) 1 × RJ45, 8-pole metal, CAT6A (female/female) 1 × data cut-out</p>	Screw terminals: max. 2 × 4 mm ² (AWG 12) Operating voltage: 250 V AC Operating current: 16 A shielded	4000-68000-4530001
	<p>Italy (CEI 23-16); SUB-D9 1 × Italy (CEI 23-16) 1 × SUB-D9 (male/female) 1 × SUB-D9 cut-out</p>	Screw terminals: max. 2 × 4 mm ² (AWG 12) Operating voltage: 250 V AC Operating current: 16 A shielded	4000-68000-4530004
	<p>Denmark 1 × Denmark (white) 2 × data cut-out</p>	Spring clamp terminals: max. 2 × 2.5 mm ² (AWG 14) Operating voltage: 250 V AC Operating current: max. 13 A shielded	4000-68000-4550000

Combinations			Art-No.
	<p>Denmark 1 × Denmark (white) 1 × RJ45, 8-pole metal, CAT6A (female/female) 1 × data cut-out</p>	<p>Spring clamp terminals: max. 2 × 2.5 mm² (AWG 14) Operating voltage: 250 V AC Operating current: max. 13 A shielded</p>	<p>4000-68000-4550001</p>
	<p>Swiss 1 × Swiss 2 × data cut-out</p>	<p>Spring clamp terminals: max. 2 × 1.5 mm² (AWG 16) Operating voltage: 250 V AC Operating current: max. 10 A shielded</p>	<p>4000-68000-4540000</p>
	<p>Swiss; RJ45 1 × Swiss 1 × RJ45, 8-pole metal, CAT6A (female/female) 1 × data cut-out</p>	<p>Spring clamp terminals: max. 2 × 1.5 mm² (AWG 16) Operating voltage: 250 V AC Operating current: max. 10 A shielded</p>	<p>4000-68000-4540001</p>
	<p>India (IS 1293) 1 × India (white) 2 × data cut-out</p>	<p>Screw terminals: max. 2 × 1.5 mm² (AWG 16) Operating voltage: 240 V AC Operating current: max. 5 A shielded</p>	<p>4000-68000-4570000</p>
	<p>India (IS 1293); RJ45 1 × India (white) 1 × RJ45, 8-pole metal, CAT6A (female/female) 1 × data cut-out</p>	<p>Screw terminals: max. 2 × 1.5 mm² (AWG 16) Operating voltage: 240 V AC Operating current: max. 5 A shielded</p>	<p>4000-68000-4570001</p>
	<p>China (CCC) 1 × China (white) 2 × data cut-out</p>	<p>Screw terminals: max. 2 × 4 mm² (AWG 12) Operating voltage: 250 V AC Operating current: max. 10 A shielded</p>	<p>4000-68000-4580000</p>
	<p>China (CCC); RJ45 1 × China (white) 1 × RJ45, 8-pole metal, CAT6A (female/female) 1 × data cut-out</p>	<p>Screw terminals: max. 2 × 4 mm² (AWG 12) Operating voltage: 250 V AC Operating current: max. 10 A shielded</p>	<p>4000-68000-4580001</p>



FRONT PANEL INTERFACES

Combinations			Art-No.
	Brazil 1 × Brazil 4 × data cut-out	Screw terminals: max. 2 × 1.5 mm ² (AWG 16) Operating voltage: 250 V AC Operating current: max. 10 A	4000-68000-4610000
	Brazil; RJ45 1 × Brazil 1 × RJ45, 8-pole metal, CAT6A (female/female) 3 × data cut-out	Screw terminals: max. 2 × 1.5 mm ² (AWG 16) Operating voltage: 250 V AC Operating current: max. 10 A shielded	4000-68000-4610001
	Brazil; SUB-D9 1 × Brazil 1 × SUB-D9 (male/female) 1 × SUB-D9 cut-out	Screw terminals: max. 2 × 1.5 mm ² (AWG 16) Operating voltage: 250 V AC Operating current: max. 10 A shielded	4000-68000-4610004
	Germany (VDE); RJ45; FI-cut-out 1 × VDE 1 × RJ45, 8-pole metal, CAT5e (female/female) 1 × FI cut-out		4000-68000-4300001
	Germany (VDE) yellow; RJ45; FI-cut-out 1 × VDE yellow 1 × RJ45, 8-pole metal, CAT5e (female/female) 1 × FI cut-out		4000-68000-4390001
	France (UTE-NF); RJ45; FI-cut-out 1 × France (UTE-NF) white 1 × RJ45, 8-pole metal, CAT5e (female/female) 1 × FI cut-out		4000-68000-4310001
	USA (2 × NEMA-GFCI 5-15); RJ45; USB (form A); fuse 2 × NEMA-GFCI 5-15 (screw terminals) 1 × RJ45, 8-pole metal, CAT5e (female/female) 1 × USB (female/female) form A 1 × fuse (3 A)	cURus with touch protection	4000-68000-4100000

FRONT PANEL INTERFACES

Combinations			Art-No.
	USA (2 × NEMA-GFCI 5-15); RJ45; fuse 2 × NEMA-GFCI 5-15 (screw terminals) 1 × RJ45, 8-pole metal, CAT5e (female/female) 1 × fuse (3 A)	cURus with touch protection	4000-68000-4110000
	USA (2 × NEMA-GFCI 5-15); RJ45; RJ45; fuse 2 × NEMA-GFCI 5-15 (screw terminals) 2 × RJ45, 8-pole metal, CAT5e (female/female) 1 × fuse (3 A)	cURus with touch protection	4000-68000-4120000
	USA (2 × NEMA-GFCI 5-15); RJ45; SUB-D9; fuse 2 × NEMA-GFCI 5-15 (screw terminals) 1 × RJ45, 8-pole metal, CAT5e (female/female) 1 × SUB-D9 (male/female) 1 × fuse (3 A)	cURus with touch protection	4000-68000-4130000
	USA (2 × NEMA-GFCI 5-15); fuse 2 × NEMA-GFCI 5-15 (screw terminals) 1 × fuse (3 A)	cURus with touch protection	4000-68000-4140000
	Great Britain (BS); RJ45; FI cut-out 1 × Great Britain (BS) 1 × RJ45, 8-pole metal, CAT5e (female/female) 1 × FI cut-out		4000-68000-4320001
	Italy (CEI 23-16); RJ45; FI cut-out 1 × Italy (CEI 23-16) 1 × RJ45, 8-pole metal, CAT5e (female/female) 1 × FI cut-out		4000-68000-4330001
	Swiss; RJ45; FI cut-out 1 × Swiss 1 × RJ45, 8-pole metal, CAT5e (female/female) 1 × FI cut-out		4000-68000-4340001
	Australia; RJ45; FI cut-out 1 × Australia 1 × RJ45, 8-pole metal, CAT5e (female/female) 1 × FI cut-out		4000-68000-4360001

FRONT PANEL INTERFACES

Pass-through			Art-No.
	Pass-through 1 × RJ45, 8-pole metal, CAT5e (female/female)	cULus	4000-73000-0010000
	Pass-through 1 × USB 3.0 (female/male) form A, 0.6 m cable 1 × USB 3.0 (female/male) form A, 1.0 m cable 1 × USB 3.0 (female/male) form A, 1.5 m cable 1 × USB 3.0 (female/male) form A, 2.0 m cable	cULus cULus cULus cULus	4000-73000-0150000 4000-73000-0160000 4000-73000-0170000 4000-73000-0180000

FRONT PANEL INTERFACES

Connection accessories			Art-No.
	Gender Changer RJ45 (female /female)	cURus	4000-68000-9040010
	Gender Changer RJ12; (female/female)		4000-68000-9040011
	Gender Changer RJ45 (female /female) Zinc die casting, nickel-plated	cURus	4000-68000-9040012
	Gender Changer USB (form A) 3.0 (female/female)		4000-68000-9040022
	Gender Changer SUB-D9 (female/female)	cURus	4000-68000-9040030
	SUB-D9 (female/male)	cURus	4000-68000-9040031
	Gender Changer SUB-D9 (male/male)	cURus	4000-68000-9040032
	Gender Changer SUB-D15 (female/male)	cURus	4000-68000-9040040
	SUB-D15 (female/female)	cURus	4000-68000-9040041
	Gender Changer SUB-D15 (male/male)	cURus	4000-68000-9040042
	Gender Changer SUB-D15 HD (female/male) VGA	cURus	4000-68000-9040045

FRONT PANEL INTERFACES

Connection accessories			Art-No.
	Gender Changer		
	SUB-D25 (female/female)	cURus	4000-68000-9040050
	SUB-D25 (female/male)	cURus	4000-68000-9040051
	Cables		
	SUB-D9 (male/male); 2 m	shielded	4000-68000-9030010
	SUB-D9 (male/male); 5 m	shielded	4000-68000-9030011
	SUB-D9 (female/male); 2 m	shielded	4000-68000-9030020
	SUB-D9 (female/male); 5 m	shielded	4000-68000-9030021
	Cables		
	SUB-D25 (female/male); 1.8 m	shielded	4000-68000-9030040
	SUB-D25 (female/male); 5 m	shielded	4000-68000-9030041
	Cables		
	USB (form A to A); 2 m (male/male)	shielded	4000-68000-9030050
	USB (form A to A); 5 m (male/male)	shielded	4000-68000-9030051
	USB (form A to A); 2 m (male/male) PUR	shielded	4000-68000-9030052
	USB (form A to A); 5 m (male/male) PUR	shielded	4000-68000-9030053
	USB (form A to B); 2 m	shielded	4000-68000-9030054
	USB (form A to B); 5 m	shielded	4000-68000-9030055
	Cables		
	RJ45 (8/8-pole) metal, CAT6; 2 m	shielded	4000-68000-9030060
	RJ45 (8/8-pole) metal, CAT6; 5 m	shielded	4000-68000-9030061
	RJ45 (8/8-pole) metal, CAT6; 10 m	shielded	4000-68000-9030062
Mounting accessories			Art-No.
	Ground strap 6 mm²		
	100 mm for screw (M4)		4000-71001-0610004
	200 mm for screw (M4)		4000-71001-0620004
	300 mm for screw (M4)		4000-71001-0630004
	Blind plate (flat)		
	Self-installation available space: 45 × 75 mm	cURus	4000-68000-8900000
	Blind plate (depth)		
	Self-installation available space: 34 × 58 mm Cavity: 13 mm deep	cURus	4000-68000-8910000

Mounting accessories			Art-No.
	<p>Blind plates (pre-cut) 1 × USB, 1 × RJ45, SUB-D9</p>	<p>cURus shielded</p>	<p>4000-68000-8500000</p>
	<p>Blind plates (pre-cut) 1 × USB, 1 × RJ45, 1 × SUB-D25</p>	<p>cURus shielded</p>	<p>4000-68000-8510000</p>
	<p>Housing (1-way) with 4 blind plugs (M16 × 1.5) H × W × D: 180×94×81 mm</p>		<p>4000-68000-9060010</p>
	<p>Housing (2-way) with 6 blind plugs (M16 × 1.5) H × W × D: 182×180×90 mm</p>		<p>4000-68000-9060020</p>
	<p>Touch protection box for double frame H × W × D: 124×124×67 mm</p>	<p>cURus</p>	<p>4000-68000-9140000</p>
	<p>Touch protection box for single frame H × W × D: 115×87×66 mm</p>	<p>cURus</p>	<p>4000-68000-9180000</p>
	<p>Cable compression gland M16</p>	<p>Sealing range (cable Ø): 4...8 mm</p>	<p>4000-68000-9060030</p>
	<p>Label plate Frame: 20 pcs</p>	<p>cURus</p>	<p>4000-68000-9000000</p>

CONTROL CABINET INTERFACES / CABLE ENTRY SYSTEMS

- Durable connections
- Modular system
- High protection degree

MODLINK MPV CABLE ENTRY SYSTEM

The article numbers help you figure out whether you are ordering inserts, individual frames or sets. A set has one part number for up to three components.

THE MODLINK MPV SET

The set article number is made up of **A**, **B** and **C**.

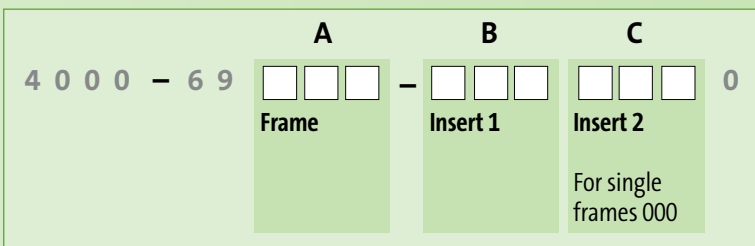

First select your components:

- Block A:** Frame (e. g. 4000-69**122**-000 0000 for double frame)
Block B: Insert 1 (e. g. 4000-69000-**100** 0000 for M12 / SUB-D)
Block C: Insert 2 (e. g. 4000-69000-**200** 0000 for 7/8" / spring clamp terminal)

The article number for this example set will be:

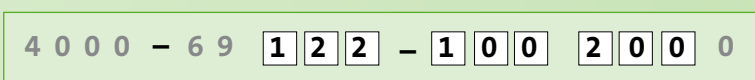

Control Cabinet Interfaces



Modlink MPV – modular

- Frames
- Inserts
- Accessories

Page 2.2.1

Cable Entry Systems



Cable entry system – modular

- Cable entry plate
- Inserts

Page 2.2.3



Cable entry system – predefined

- Rectangular
- Round

Page 2.2.4

MPV Frame		Art-No.
	Single for standard cut-out Size 6 (35 × 52 mm) IP65	cURus 4000-69112-0000000
	Double for standard cut-out Size 24 (35 × 112 mm) IP65	cURus 4000-69122-0000000
	Single (30°-angle) for standard cut-out Size 6 (35 × 52 mm) IP65	cURus 4000-69212-0000000
	Double (30°-angle) for standard cut-out Size 24 (35 × 112 mm) IP65	cURus 4000-69222-0000000
MPV Inserts		Art-No.
	M12 M12 (male/female) 5-pole IP65	cURus 4000-69000-1040000
	M12 (male/female) 5-pole, B-coded IP65	cURus 4000-69000-1060000
	M12 (male/female) 6-pole, Cube67 IP65	cURus 4000-69000-1080000
	M12; SUB-D9 M12 (female) B-coded SUB-D9 (female) IP65	cURus 4000-69000-1000000
	M12; terminators M12 (female) 5-pole, A-coded Spring clamp terminal connection IP65	 4000-69000-1050000

CONTROL CABINET INTERFACES / CABLE ENTRY SYSTEMS

MPV Inserts			Art-No.
	<p>M12; terminators M12 (female) 5-pole, A-coded Screw terminal connection (yellow) Safety IP65</p>		4000-69000-1090000
	<p>M12; RJ45 M12 (female) 4-pole, D-coded RJ45 (8/8-pole) metal, CAT6 IP65</p>		4000-69000-1100000
	<p>7/8"; Spring clamp terminal 7/8" (female) Spring clamp terminal connection IP65</p>	cURus	4000-69000-2000000
	<p>7/8"; Spring clamp terminal 7/8" (male) Spring clamp terminal connection</p>		4000-69000-2040000
	<p>RJ45 RJ45 (8/8-pole) metal, CAT6 IP65</p>	cURus	4000-69000-2500000
	<p>LWL Fiber Optic (male/male) single mode IP65</p>		4000-69000-5200000
MPV accessories			Art-No.
	<p>Blind insert for sealing of unused openings IP65</p>	cURus	4000-69000-9000000

CONTROL CABINET INTERFACES / CABLE ENTRY SYSTEMS

MPV accessories			Art-No.
	RJ45 Male straight, 4-pole IP65		4000-69000-9500050
	RJ45 Male 90°, 4-pole IP65		4000-69000-9500060
	Control cabinet entry system M12 straight, A-coded, 5-pole, shielded straight, B-coded, 5-pole, shielded straight, A-coded, 6-pole, shielded	DeviceNet, CANopen PROFIBUS, Interbus Cube67	7000-42111-0000000 7000-44111-0000000 7000-46111-0000000
	Control cabinet entry system M12 straight, D-coded, 4-pole, shielded (female/female)	Ethernet CAT5	7000-44611-0000000
Connectors			Art-No.
	Size 16 for 4 cables (0 large, 4 small) for 5 cables (1 large, 4 small) for 8 cables (0 large, 8 small)		4000-70103-0004000 4000-70103-0104000 4000-70103-0008000
	Size 24 for 4 cables (2 large, 2 small) for 7 cables (1 large, 6 small) for 10 cables (0 large, 10 small)		4000-70103-0202000 4000-70103-0106000 4000-70103-0010000

CONTROL CABINET INTERFACES / CABLE ENTRY SYSTEMS

Cable entry glands			Art-No.	
	with cable tie eye			
	Cable diameter (3...4 mm) Cable diameter (4...5 mm) Cable diameter (5...6 mm) Cable diameter (6...7 mm) Cable diameter (7...8 mm) Cable diameter (8...9 mm) Cable diameter (9...10 mm) Cable diameter (10...11 mm) Cable diameter (11...12 mm) Cable diameter (12...13 mm) Cable diameter (13...14 mm) Cable diameter (14...15 mm) Cable diameter (15...16 mm) Cable diameter (16...17 mm) Cable diameter (17...18 mm) Cable diameter (18...19 mm) Cable diameter (19...20 mm) Cable diameter (20...21 mm) Cable diameter (21...22 mm) Cable diameter (22...23 mm) Cable diameter (23...24 mm) Cable diameter (24...25 mm) Cable diameter (24...25 mm) Cable diameter (26...27 mm) Cable diameter (27...28 mm) Cable diameter (28...29 mm) Cable diameter (29...30 mm) Cable diameter (30...31 mm)		4000-70403-0001030 4000-70403-0001040 4000-70403-0001050 4000-70403-0001060 4000-70403-0001070 4000-70403-0001080 4000-70403-0001090 4000-70403-0001100 4000-70403-0001110 4000-70403-0001120 4000-70403-0001130 4000-70403-0001140 4000-70403-0001150 4000-70403-0100160 4000-70403-0100170 4000-70403-0100180 4000-70403-0100190 4000-70403-0100200 4000-70403-0100210 4000-70403-0100220 4000-70403-0100230 4000-70403-0100240 4000-70403-0100250 4000-70403-0100260 4000-70403-0100270 4000-70403-0100280 4000-70403-0100290 4000-70403-0100300	
		Special		
		Blind plug (plugs) single		4000-70503-0001010
		Blind plug (plugs) double		4000-70503-0100010
		Adapter		4000-70503-0100020
		for 1 AS-Interface cable		4000-70503-0001020
		for 2 AS-Interface cables		4000-70503-0001030
		for 2 cables (Ø 6 mm)		4000-70503-0001060
	for 2 cables (Ø 5 mm)		4000-70503-0001050	
	Plates			Art-No.
		Size 24		
		Cable diameter (12) × 8...12 mm		4000-70603-0240120
		Cable diameter (6) × 3...6.5 mm, (4) × 5...9.2 mm, (4) × 9.6...15.9 mm		4000-70603-0240140
		Cable diameter (17) × 5...9.2 mm		4000-70603-0240170
		Cable diameter (16) × 3...6.5 mm, (4) × 5...9.2 mm, (2) × 8...12.5 mm		4000-70603-0240220
		Cable diameter (23) × 4.3...8.1 mm		4000-70603-0240230
	Cable diameter (29) × 3...6.5 mm		4000-70603-0240290	
		M50		
		Cable diameter (3) × 6...10 mm, (1) × 9.6...15.9 mm		4000-70703-0500040
		Cable diameter (1) × 3...5.5 mm, (5) × 5...9.2 mm		4000-70703-0500060
		Cable diameter (7) × 3...6.5 mm, (1) × 6...10 mm		4000-70703-0500080
Locknut		4000-70704-0500000		

Plates			Art-No.
	M63 Cable diameter (2) × 3...6.5 mm, (4) × 5...9.2 mm, (2) × 9.6...15.9 mm		4000-70703-0630080
	Cable diameter (6) × 3...5.5 mm, (6) × 3...6.5 mm, (1) × 6...10 mm		4000-70703-0630130
	Cable diameter (19) × 3...5 mm		4000-70703-0630190
	Locknut		4000-70704-0630000
Accessories			Art-No.
	Blind plate Size 16		4000-70202-0001000
	Blind plate Size 24		4000-70202-0002000
	Adapter from size 24 to 16		4000-70203-0100000
	Cable strain relief for 1 cable		4000-70302-0000010
	for 5 cables		4000-70302-0000050
	for 9 cables		4000-70302-0000090
	Label plate 20 × 9 mm		4000-70920-0000000
	Cable tie for small glands L = 75 mm		4000-70902-0075220
	for large glands L = 160 mm		4000-70902-0160450
	for large glands L = 180 mm		4000-70902-0180800



HYBRID FIELDBUS COUPLING

- For durable connections
- A high degree of protection
- Repeater included

EASILY CONNECTED – QUICKLY AND SAFELY

MSDD hybrid fieldbus couplers transfer data and power from the cabinet into the industrial field. A repeater function amplifies and processes signals.

Active hybrid fieldbus coupling offers many benefits:

- Repeater and control cabinet interface in one module
- PROFIBUS FMS/DP galvanically separated
- Three independent PROFIBUS ports
- All three PROFIBUS segments are galvanically separated
- Baud rate change during operation – automatic and continuous Baud rate detection
- 3 × segment length – 200 m at 1.5 Mbit/s and 100 m at 12 Mbit/s
- Cascading capabilities for 31 modules per PROFIBUS segment
- Integrated terminating resistor

MSDD Hybrid Fieldbus Coupling



Active Hybrid Fieldbus Coupling

Active connection between control cabinet and fieldbus area (incl. repeater)

An overview of this product range can be found in our online shop



Passive Hybrid Fieldbus Coupling

Passive connection between control cabinet and fieldbus area

An overview of this product range can be found in our online shop



LIGHTING ELEMENTS MAXIMUM FLEXIBILITY

- High light yield
- Long life
- Plug-in solutions

DISTINCT SIGNALS AND PERFECT ILLUMINATION IN DAYLIGHT QUALITY

Modlight Pro LED signal towers

The signal towers are characterized by maximum flexibility in color selection and color composition. The elements of the signal towers with diameters of 50 and 70 millimeters are connected by bayonet locks, making for easy and quick assembly. The signal towers can be flexibly mounted.

Modlight Illumix LED machine light

The machine lights of the Modlight Illumix series ensure optimal illumination of machines and systems based on maintenance-free and durable LED technology in daylight quality. Rotatable mounting brackets provide flexibility in attaching the lights.

Signal lights



Modlight50 Pro / Modlight70 Pro

- 50/70 mm
- Connecting elements
- Buzzer modules
- LED modules

Page 2.4.1



Sets – Modlight30 / Modlight50 Pro / Modlight70 Pro

- 30/50/70 mm
- LED signal towers

Page 2.4.2



Comlight57

- 57 mm
- Single lights
- LED

Page 2.4.3

Machine lights



Modlight Illumix Slim Line

- Machine light (LED)
- Degree of protection IP54

Modlight Illumix Classic Line

- Machine light (LED)
- Degree of protection IP67

Page 2.4.5



Modlight Illumix Xtreme

- Machine light (LED)
- Degree of protection IP69K

Page 2.4.6

Connection modules			Art-No.
	Base for floor mount Modlight50 Pro	Spring clamp terminals cURus	4000-76050-1100002
	Base for floor mount Modlight70 Pro	Spring clamp terminals cURus	4000-76070-1100002
	Basic for tube mounting Modlight50 Pro	Spring clamp terminals cURus	4000-76050-1100003
	Basic for tube mounting Modlight70 Pro	Spring clamp terminals cURus	4000-76070-1100003
	Basic Modlight70 Pro	M12 (8-pole), down	4000-76070-1300002
	Basic Modlight70 Pro	M12 (8-pole), sideways	4000-76070-1400002
	Basic with magnet base Modlight70 Pro	M12 (8-pole), sideways	4000-76070-1500002
Buzzer modules			Art-No.
	Buzzer module Modlight50 Pro		4000-76050-1100004
	Buzzer module Modlight70 Pro		4000-76070-1100004
LED modules			Art-No.
	LED module Modlight50 Pro	red	4000-76050-1011000
	LED module Modlight70 Pro	red	4000-76070-1011000
	LED module Modlight50 Pro	yellow	4000-76050-1012000
	LED module Modlight70 Pro	yellow	4000-76070-1012000

LIGHTING ELEMENTS

LED modules			Art-No.
	LED module Modlight50 Pro	green	4000-76050-1013000
	LED module Modlight70 Pro	green	4000-76070-1013000
	LED module Modlight50 Pro	blue	4000-76050-1014000
	LED module Modlight70 Pro	blue	4000-76070-1014000
	LED module Modlight50 Pro	clear	4000-76050-1015000
	LED module Modlight70 Pro	clear	4000-76070-1015000
Sets			Art-No.
	Modlight30 (green/yellow/red)		
	Connection module + LED modules	Connection cable L = 300 mm	4000-75324-5310000
	Modlight50 Pro (green/yellow/red)		
	Basic + LED modules		4000-76501-5310000
	Modlight70 Pro (green/yellow/red)		
	Basic + LED modules + M12 (down)		4000-76704-5310000
	Modlight70 Pro (green/yellow/red)		
	Basic + LED modules + M12 (side)		4000-76712-5310000
	Basic, buzzer + LED modules + M12 (down)		4000-76705-5310000
	Basic, buzzer + LED modules + M12 (side)		4000-76713-5310000

Compact status lights			Art-No.
	Comilight57 red	Spring clamp terminal connection	4000-75057-1111000
	red	Connection M12 (on bottom)	4000-75057-1311000
	Comilight57 yellow	Spring clamp terminal connection	4000-75057-1112000
	yellow	Connection M12 (on bottom)	4000-75057-1312000
	Comilight57 green	Spring clamp terminal connection	4000-75057-1113000
	green	Connection M12 (on bottom)	4000-75057-1313000
	Comilight57 blue	Spring clamp terminal connection	4000-75057-1114000
	blue	Connection M12 (on bottom)	4000-75057-1314000
	Comilight57 clear	Spring clamp terminal connection	4000-75057-1115000
	clear	Connection M12 (on bottom)	4000-75057-1315000

LIGHTING ELEMENTS

Accessories Modlight30			Art-No.
	Adapter for wall assembly		4000-75030-0000903
Accessories Modlight50/70 Pro			Art-No.
	Bottom adapter for tube mounting	for Modlight50/70 Pro	4000-76070-0000901
	Adapter for tube/wall mounting	for Modlight50/70 Pro	4000-76070-0000902
	Adapter for wall assembly	for Modlight70 Pro	4000-76070-0000903
	Adapter for wall assembly Cable outlet (on the bottom)	for Modlight70 Pro	4000-75070-0000904
	Aluminum tube 300 mm	for Modlight50/70 Pro	4000-76070-0000913
	800 mm	for Modlight50/70 Pro	4000-76070-0000918
	Magnet base with M16 × 1.5 gland	Sideways cable entry point for Modlight50/70 Pro	4000-75070-0000920
	Magnet base with M12 flange plug connector (8-pole)	Sideways connection for Modlight50/70 Pro	4000-75070-0000921

Accessories Modlight50/70 Pro			Art-No.
	Mounting adapter for strain relief	bottom or side exit	4000-75070-0000922
	Label plate transparent	for Modlight50 Pro	4000-76050-0000923
	transparent	for Modlight70 Pro	4000-76070-0000923
LED machine lights			Art-No.
	Modlight Illumix Slim Line 4 W - 24 V DC Connection M8	IP54 cULus	4000-75800-1715004
	8 W - 24 V DC Connection M8	IP54 cULus	4000-75800-1715008
	16 W - 24 V DC Connection M8	IP54 cULus	4000-75800-1715016
	24 W - 24 V DC Connection M8	IP54 cULus	4000-75800-1715024
	32 W - 24 V DC Connection M8	IP54 cULus	4000-75800-1715032
	Modlight Illumix Slim Line C 4 W - 24 V DC Connection M8 expandability	IP54 cULus	4000-75900-1715004
	8 W - 24 V DC Connection M8 expandability	IP54 cULus	4000-75900-1715008
	16 W - 24 V DC Connection M8 expandability	IP54 cULus	4000-75900-1715016
	24 W - 24 V DC Connection M8 expandability	IP54 cULus	4000-75900-1715024
	32 W - 24 V DC Connection M8 expandability	IP54 cULus	4000-75900-1715032
	Modlight Illumix Classic Line 6 W - 24 V DC Connection M12	IP67 cULus	4000-75801-1415006
	12 W - 24 V DC Connection M12	IP67 cULus	4000-75801-1415012
	18 W - 24 V DC Connection M12	IP67 cULus	4000-75801-1415018
	24 W - 24 V DC Connection M12	IP67 cULus	4000-75801-1415024

LIGHTING ELEMENTS

LED machine lights			Art-No.
	<p>Modlight Illumix Classic Line C</p> <p>6 W - 24 V DC Connection M12 expandability</p> <p>12 W - 24 V DC Connection M12 expandability</p> <p>18 W - 24 V DC Connection M12 expandability</p> <p>24 W - 24 V DC Connection M12 expandability</p>	<p>IP67 cULus</p> <p>IP67 cULus</p> <p>IP67 cULus</p> <p>IP67 cULus</p>	<p>4000-75901-1415006</p> <p>4000-75901-1415012</p> <p>4000-75901-1415018</p> <p>4000-75901-1415024</p>
	<p>Modlight Illumix Xtreme</p> <p>27 W - 24 V DC Connection M12</p>	<p>IP69K cULus</p>	<p>4000-75827-1315000</p>
	<p>Modlight Illumix Xtreme</p> <p>Joint coupling</p>		<p>4000-75800-0000900</p>

Lighting Elements



CONTROL DEVICES EMERGENCY STOP AND RESET PUSHBUTTONS

- Easy mounting
- Error-free connection
- Suitable for applications in the safety technology

FAST AND ERROR-FREE WIRING WITH STANDARD CABLES

The **EMERGENCY STOP** and **RESET** buttons from Murrelektronik can be integrated very easily in electronic installations

These control and monitoring devices can be connected via preconfigured M12 cables (4-, 5-, or 8-pole). A time-saving solution excluding the risk of faulty wirings. The 'Plug & Play' feature makes integrating the control devices in machines and systems faster.

42 mm variants



E-Stop button

- With M12 connection
- 4-, 5-, or 8-pole variants

Page 2.5.1



R-Button

- With M12 connection
- 4- or 8-pole variants

Page 2.5.1

72 mm variants



E-Stop button

- With M12 connection
- 4-, 5-, or 8-pole variants
- With/without protective collar

Page 2.5.1

Control devices			Art-No.
	E-Stop 42 2NC M12(4) M12 (4-pole)	Emergency-Stop button 2 NC (positively-opening)	69000
	E-Stop 42 2NC M12(5) M12 (5-pole)	Emergency-Stop button 2 NC (positively-opening)	69001
	E-Stop 42 2NC L M12(8) M12 (8-pole)	Emergency-Stop button 2 NC (positively-opening) LED-Ring can be lit	69002
	E-Stop / R-B 42 2NC 1NO M12(8) M12 (8-pole)	Emergency-Stop button 2 NC (positively-opening) 1 button (1 NO contact) Flat lens, transparent clear, red, yellow, green, blue	69003
	E-Stop / R-B 42 2NC 1NO L M12(8) M12 (8-pole)	Emergency-Stop button 2 NC (positively-opening) 1 button can be lit (1 NO contact) Flat lens, transparent clear, red, yellow, green, blue	69004
	R-Button / 42 1NO M12(4) M12 (4-pole)	1 button (1 NO contact) Flat lens, transparent clear, red, yellow, green, blue	69010
	R-Button / 42 1NO L M12(4) M12 (4-pole)	1 button can be lit (1 NO contact) Flat lens, transparent clear, red, yellow, green, blue	69013
	R-Button / 42 2NO M12(4) M12 (4-pole)	2 buttons (each 1 NO contact) Flat lens, transparent clear, red, yellow, green, blue	69011
	R-Button / 42 2NO L M12(8) M12 (8-pole)	2 buttons can be lit (each 1 NO contact) Flat lens, transparent clear, red, yellow, green, blue	69012
	E-Stop 72 2NC M12(4) M12 (4-pole)	Emergency-Stop button 2 NC (positively-opening)	55550
	E-Stop 72 2NC M12(5) M12 (5-pole)	Emergency-Stop button 2 NC (positively-opening)	69041
	E-Stop 72 2NC L M12(8) M12 (8-pole)	Emergency-Stop button 2 NC (positively-opening) LED-Ring can be lit	69043
	E-Stop 72P 2NC M12(4) M12 (4-pole)	Emergency-Stop button 2 NC (positively-opening) with protection shroud	69040
	E-Stop 72P 2NC M12(5) M12 (5-pole)	Emergency-Stop button 2 NC (positively-opening) with protection shroud	69042

CONTROL DEVICES

Accessories control devices			Art-No.
	T-coupler (SlimLine) M12 - M12 Male straight - female/male straight	for 8-pole Emergency-Stop button	7030-42622-0000000

Control devices



MODLINK VARIO MEDIA CONNECTOR

- Easy mounting and dismounting without the need of tools
- Maximum robustness, all components being made of solid metal
- Electronics and media in one coupling

MAXIMUM MODULARITY IN INDUSTRIAL ENVIRONMENT

Modlink Vario is a modular media connector to couple and decouple pneumatics, fluids and electronics with just one system.

It is suitable for uncomplicated use on switch cabinets, tools and machine parts. Its unique feature is that it allows simultaneous non-drip coupling under pressure of electrical connections and media. The basic modules are available in 4, 6, 8 or 10 different models.

For each bore, the type of application, pneumatics, fluids or electronics, can be freely selected. This gives almost unlimited equipment options.

Base body



Round or rectangular

- Different locking types (union nut, lever)
- Connections made of aluminum or stainless steel
- Different types (e.g. 4, 6, 8, and 10 connections)

Page 2.6.1

An overview of this product range can be found in our online shop

Inserts

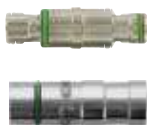

Inserts





- Inserts for power and media supply
- Inserts for the connection of different M12 connecting cables
- Pneumatics and fluid inserts for a variety of hose diameters

Page 2.6.2

MODULAR CONNECTION SYSTEMS (MODLINK VARIO)

Stationary housing (round)			Art-No.
	4-way	Aluminium	M1850-040601
		Stainless Steel 1.4404 (V4A)	M1851-040601
	6-way	Aluminium	M1850-060601
		Stainless Steel 1.4404 (V4A)	M1851-060601
	8-way	Aluminium	M1850-080601
		Stainless Steel 1.4404 (V4A)	M1851-080601
	10-way	Aluminium	M1850-100601
		Stainless Steel 1.4404 (V4A)	M1851-100601
Mobile housing (round)			Art-No.
	4-way	Aluminium	M1850-040602
		Stainless Steel 1.4404 (V4A)	M1851-040602
	6-way	Aluminium	M1850-060602
		Stainless Steel 1.4404 (V4A)	M1851-060602
	8-way	Aluminium	M1850-080602
		Stainless Steel 1.4404 (V4A)	M1851-080602

MODULAR CONNECTION SYSTEMS (MODLINK VARIO)

Mobile housing (round)			Art-No.
	10-way	Aluminium	M1850-100602
		Stainless Steel 1.4404 (V4A)	M1851-100602
Stationary housing (rectangular)			Art-No.
	8-way	Aluminium	M1856-24080611
Mobile housing (rectangular)			Art-No.
	8-way	Aluminium	M1856-24080612
Inserts Media (Stationary housing)			Art-No.
	AD4 without shut-off	Brass, nickel plated	MVT1821-062406021
	AD6 without shut-off	Brass, nickel plated	MVT1821-062406041
	AD8 without shut-off	Brass, nickel plated	MVT1821-062406061
	AD4 with shut-off	Brass, nickel plated	MVT1820-062406021
	AD6 with shut-off	Brass, nickel plated	MVT1820-062406041
	AD8 with shut-off	Brass, nickel plated	MVT1820-062406061
	AD6 drip-free	Brass, dezincification-resistant	MVT1825-262406041
	AD8 drip-free	Brass, dezincification-resistant	MVT1825-262406061

MODULAR CONNECTION SYSTEMS (MODLINK VARIO)

Inserts Media (Mobile housing)			Art-No.
	AD4 without shut-off	Brass, nickel plated	MVT1821-062406022
	AD6 without shut-off	Brass, nickel plated	MVT1821-062406042
	AD8 without shut-off	Brass, nickel plated	MVT1821-062406062
	AD4 with shut-off	Brass, nickel plated	MVT1820-062406022
	AD6 with shut-off	Brass, nickel plated	MVT1820-062406042
	AD8 with shut-off	Brass, nickel plated	MVT1820-062406062
	AD6 drip-free	Brass, dezincification-resistant	MVT1825-262406042
	AD8 drip-free	Brass, dezincification-resistant	MVT1825-262406062
	Inserts Electro (Stationary housing)		
	M12, 5-pole	A-coded	7000-42114-0000000
	M12, 4-pole	B-coded	7000-44114-0000000
	M12, 6-pole	A-coded	7000-46114-0000000
	M12, 8-pole	A-coded	7000-48114-0000000
	M12, 4-pole	D-coded	7000-44624-0000000
Inserts Electro (Mobile housing)			Art-No.
	M12, 5-pole	A-coded	7000-42116-0000000
	M12, 4-pole	B-coded	7000-44116-0000000
	M12, 6-pole	A-coded	7000-46116-0000000
	M12, 4-pole	A-coded	7000-48116-0000000
	M12, 4-pole	D-coded	7000-44586-0000000



MODLINK HEAVY HEAVY DUTY CONNECTOR

- **Maximum variety**
- **High tightness**
- **Worldwide use**

MAXIMUM MODULARITY IN INDUSTRIAL ENVIRONMENT

The heavy-duty plug connectors of the Modlink Heavy series from Murrelektronik guarantee secure transmission of signals, energy, data and pneumatics - even in the roughest of industrial environments. They consistently protect interfaces from water, dirt and high mechanical loads.

We provide a broad range of products. For our customers, we offer a matching connector for every requirement - Flexibility in the configuration of the plug connectors is our great strength. Thus, for housings, we offer as many as four different types, each in seven different sizes. They can be locked, as needed, by three different methods. As for contact inserts, you can choose from a large number of fixed-pole or modular versions. Our offer of accessories is exactly tuned to the heavy-duty plug connectors from Murrelektronik and rounded off to the last detail.

Housings



- 4 housing types
- 7 different sizes
- 3 locking types
- Outgoing cables in all directions

Page 2.7.1

An overview of this product range can be found in our online shop

Inserts



- Series A, D, E, EE, K, HSE, HV and Q
- 3 different connection types

Page 2.7.3

An overview of this product range can be found in our online shop

Frames and modules



- 4 frame sizes
- Modules for signals, energy, data and pneumatics







Page 2.7.5

An overview of this product range can be found in our online shop

HEAVY DUTY CONNECTORS (MODLINK HEAVY)

Hood			Art-No.
	B6 Form Looking techniques Cable outlet Threaded hole	low Single locking lever straight M20	70MH-GTDNL-A01B000
	B6 Form Looking techniques Cable outlet Threaded hole	low Single locking lever laterally M20	70MH-GTDNL-A02B000
	B10 Form Looking techniques Cable outlet Threaded hole	low Double locking lever straight M25	70MH-GTENQ-A01C000
	B10 Form Looking techniques Cable outlet Threaded hole	low Double locking lever laterally M25	70MH-GTENQ-A02C000
	B16 Form Looking techniques Cable outlet Threaded hole	high Double locking lever straight M32	70MH-GTFHQ-A01D000
	B16 Form Looking techniques Cable outlet Threaded hole	high Double locking lever laterally M32	70MH-GTFHQ-A02D000
	B24 Form Looking techniques Cable outlet Threaded hole	high Double locking lever straight M32	70MH-GTGHQ-A01D000



HEAVY DUTY CONNECTORS (MODLINK HEAVY)

Hood			Art-No.
	B24 Form Locking techniques Cable outlet Threaded hole	high Double locking lever laterally M32	70MH-GTGHQ-A02D000
Bulkhead mounted housing			Art-No.
	B6 Locking techniques Protection	Single locking lever IP65	70MH-GADNL-B000000
	B10 Locking techniques Protection	Double locking lever IP65	70MH-GAENQ-B000000
	B16 Locking techniques Protection	Double locking lever IP65	70MH-GAFNQ-B000000
	B24 Locking techniques Protection	Double locking lever IP65	70MH-GAGNQ-B000000
Surface mounted housing			Art-No.
	B6 Form Locking techniques Cable outlet Threaded hole	low Single locking lever laterally M20	70MH-GSDNL-B01B000
	Form Locking techniques Cable outlet Threaded hole	low Single locking lever double-sided M20	70MH-GSDNL-B02B000
	B10 Form Locking techniques Cable outlet Threaded hole	low Double locking lever laterally M25	70MH-GSEHQ-B01C000
	Form Locking techniques Cable outlet Threaded hole	high Double locking lever double-sided M25	70MH-GSEHQ-B02C000









HEAVY DUTY CONNECTORS (MODLINK HEAVY)

Surface mounted housing			Art-No.
	B16 Form Locking techniques Cable outlet Threaded hole	high Double locking lever laterally M32	70MH-GSFHQ-B01D000
	Form Locking techniques Cable outlet Threaded hole	high Double locking lever double-sided M32	70MH-GSFHQ-B02D000
	B24 Form Locking techniques Cable outlet Threaded hole	high Double locking lever laterally M32	70MH-GSGHQ-B01D000
	Form Locking techniques Cable outlet Threaded hole	high Double locking lever double-sided M32	70MH-GSGHQ-B02D000
Coupling housing			Art-No.
	B10 Form Locking techniques Cable outlet Threaded hole	low Double locking lever straight M25	70MH-GKENQ-B01C000
	B16 Form Locking techniques Cable outlet Threaded hole	high Double locking lever straight M32	70MH-GKFHQ-B01D000
	B24 Form Locking techniques Cable outlet Threaded hole	high Double locking lever straight M32	70MH-GKGHQ-B01D000
Fixed-pole inserts			Art-No.
	B6 Type No. of poles Connection E-Series	Male 6 Push-In terminals	70MH-ES006-DP03020

HEAVY DUTY CONNECTORS (MODLINK HEAVY)

Fixed-pole inserts			Art-No.
	B10 Type No. of poles Connection E-Series	Male 10 Push-In terminals	70MH-ES010-EP03020
	B16 Type No. of poles Connection E-Series	Male 16 Push-In terminals	70MH-ES016-FP03020
	B24 Type No. of poles Connection E-Series	Male 24 Push-In terminals	70MH-ES024-GP03020
	B6 Type No. of poles Connection E-Series	Female 6 Push-In terminals	70MH-EB006-DP03020
	B10 Type No. of poles Connection E-Series	Female 10 Push-In terminals	70MH-EB010-EP03020
	B16 Type No. of poles Connection E-Series	Female 16 Push-In terminals	70MH-EB016-FP03020
	B24 Type No. of poles Connection E-Series	Female 24 Push-In terminals	70MH-EB024-GP03020

HEAVY DUTY CONNECTORS (MODLINK HEAVY)

Frame			Art-No.
	Male B6	for 2 modules	70MH-RD02S-0000000
	Male B10	for 3 modules	70MH-RE03S-0000000
	Male B16	for 4 modules	70MH-RF04S-0000000
	Male B24	for 6 modules	70MH-RG06S-0000000
	Female B6	for 2 modules	70MH-RD02B-0000000
	Female B10	for 3 modules	70MH-RE03B-0000000
	Female B16	for 4 modules	70MH-RF04B-0000000
	Female B24	for 6 modules	70MH-RG06B-0000000
Blind module			Art-No.
	Male/female		70MH-MAA10-0000000

HEAVY DUTY CONNECTORS (MODLINK HEAVY)

Module 1-pole (axial screw connection)			Art-No.
	Male		
	Operating voltage	1 000 V AC/DC	70MH-MAB2A-0010707
	Operating current	200 A	
No. of poles	1		
	Female		
	Operating voltage	1 000 V AC/DC	70MH-MAC2A-0010707
	Operating current	200 A	
No. of poles	1		
PE modules 1-pole (axial screw connection)			Art-No.
	Male		
	Operating current	200 A	70MH-MAQ2A-0010707
	No. of poles	1 (PE)	
	Female		
	Operating current	200 A	70MH-MAR2A-0010707
	No. of poles	1 (PE)	
Module 2-pole (axial screw connection)			Art-No.
	Male		
	Operating voltage	1 000 V AC/DC	70MH-MAB1A-0020703
	Operating current	40 A	
	No. of poles	2	
	Operating voltage	1 000 V AC/DC	70MH-MAB1A-0020706
	Operating current	70 A	
	No. of poles	2	
	Operating voltage	1 000 V AC/DC	70MH-MAB2A-0020704
	Operating current	100 A	
No. of poles	2		
	Female		
	Operating voltage	1 000 V AC/DC	70MH-MAC1A-0020703
	Operating current	40 A	
	No. of poles	2	
	Operating voltage	1 000 V AC/DC	70MH-MAC1A-0020706
	Operating current	70 A	
	No. of poles	2	
	Operating voltage	1 000 V AC/DC	70MH-MAC2A-0020704
	Operating current	100 A	
No. of poles	2		

HEAVY DUTY CONNECTORS (MODLINK HEAVY)

Modules 2-pole (Crimp)			Art-No.
	Male Operating voltage Operating current No. of poles	1000 V AC/DC 100 A 2	70MH-MAF2C-0020704
	Female Operating voltage Operating current No. of poles	1000 V AC/DC 100 A 2	70MH-MAG2C-0020704
Modules 2-pole shielded (Crimp)			Art-No.
	Male No. of poles for coax- and 4-pole contact carrier	2	70MH-MAD2C-0020101
	Female No. of poles for coax- and 4-pole contact carrier	2	70MH-MAE2C-0020101
Modules 3 pole (crimp)			Art-No.
	Male Operating voltage Operating current No. of poles	690 V AC/DC (PIN - PIN); 400 V AC/DC (PIN - PE) 40 A 3	70MH-MAB1C-0030903
	Female Operating voltage Operating current No. of poles	690 V AC/DC (PIN - PIN); 400 V AC/DC (PIN - PE) 40 A 3	70MH-MAC1C-0030903
Modules 4 pole (crimp)			Art-No.
	Male Operating voltage Operating current No. of poles	830 V AC/DC 40 A 4	70MH-MAB1C-0040603

HEAVY DUTY CONNECTORS (MODLINK HEAVY)

Modules 4 pole (crimp)			Art-No.
	Female Operating voltage Operating current No. of poles	830 V AC/DC 40 A 4	70MH-MAC1C-0040603
Modules 5 pole (push-in)			Art-No.
	Male Operating voltage Operating current No. of poles	400 V AC/DC 16 A 5	70MH-MAB1P-0050402
	Female Operating voltage Operating current No. of poles	400 V AC/DC 16 A 5	70MH-MAC1P-0050402
Modules 6 pole (crimp)			Art-No.
	Male Operating voltage Operating current No. of poles	500 V AC/DC 16 A 6	70MH-MAB1C-0060502
	Female Operating voltage Operating current No. of poles	500 V AC/DC 16 A 6	70MH-MAC1C-0060502
Modules 8-pole (Crimp)			Art-No.
	Male Operating voltage Operating current No. of poles	400 V AC/DC 16 A 8	70MH-MAB1C-0080402
	Female Operating voltage Operating current No. of poles	400 V AC/DC 16 A 8	70MH-MAC1C-0080402

HEAVY DUTY CONNECTORS (MODLINK HEAVY)

Modules 12 pole (crimp)			Art-No.
	Male Operating voltage Operating current No. of poles	400 V AC/DC (PIN - PIN); 250 V AC/DC (PIN - PE) 10 A 12	70MH-MAB1C-0120801
	Female Operating voltage Operating current No. of poles	400 V AC/DC (PIN - PIN); 250 V AC/DC (PIN - PE) 10 A 12	70MH-MAC1C-0120801
Modules 17-pole (Crimp)			Art-No.
	Male Operating voltage Operating current No. of poles	160 V AC/DC 10 A 17	70MH-MAB1C-0170201
	Female Operating voltage Operating current No. of poles	160 V AC/DC 10 A 17	70MH-MAC1C-0170201
Modules 20-pole (Crimp)			Art-No.
	Male Operating voltage Operating current No. of poles	500 V AC/DC 16 A 20	70MH-MAB1C-0200502
	Female Operating voltage Operating current No. of poles	500 V AC/DC 16 A 20	70MH-MAC1C-0200502
Modules GIGABIT			Art-No.
	Male Transfer parameters	CAT6A	70MH-MAH1C-0000000

HEAVY DUTY CONNECTORS (MODLINK HEAVY)

Modules GIGABIT			Art-No.
	Female		
	Transfer parameters	CAT6A	70MH-MAL1C-0000000
Modules RJ45			Art-No.
	Male		
	Transfer parameters	CAT6A (IEC 60512-27-100:2008, TIA-568-C.2:2009)	70MH-MAL10-0000000
	Male		
	Transfer parameters	CAT5e	70MH-MAL10-0010000
	Male		
	Insert Transfer parameters	for 70MH-MAL10-0010000 CAT5	70MH-ZRJ45-1000000
	Male		
	Insert Transfer parameters	for 70MH-MAL10-0010000 CAT5	70MH-ZRJ45-2000000
	Female		
	Transfer parameters	CAT6A (IEC 60512-27-100:2008, TIA-568-C.2:2009)	70MH-MAM10-0000000
Modules pneumatic			Art-No.
	Male/female		
	2-pole	Internal hose Ø 6 mm	70MH-MAP10-0020000
	3-pole	Internal hose Ø 1.6, 3, 4 mm	70MH-MAP10-0030000



3

CONNECTION TECHNOLOGY

3

**CONNECTION
TECHNOLOGY**

M8 Round Plug Connectors	3.1
M12 Round Plug Connectors	3.2
T-couplers M8, M12, 7/8"	3.3
Flange Connectors	3.4
MQ12 Round Plug Connectors	3.5
Fieldbus Connectors	3.6
Plug Connectors for Food & Beverage	3.7
Mobile Applications	3.8
M23 Round Plug Connectors	3.9
Round Plug Connectors Power	3.10
TPE Series – The North American standard	3.11
Valve Connectors	3.12
Technical Appendix Cables	3.13



MURRELEKTRONIK'S CONNECTORS

ORDERING SYSTEM

Our concept for your individual application solutions.

Our connector range is a modular system that you can customize for your application.

ARTICLE NUMBER SYSTEM

The article number consists of three blocks: form, jacket material/color and cable length.

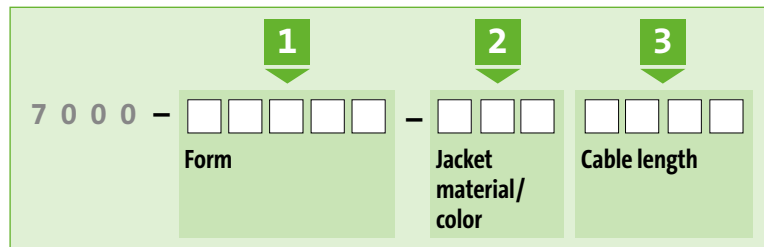

EXAMPLE

Block 1: Form	1 2 4 0 1	M12 female 90° with LED, 4-pole
Block 2: Jacket material/color	0 3 3	PUR (UL/CSA), yellow
Block 3: Cable length	0 3 0 0	3 m

The resulting part number is how you will order your connector.

7 0 0 0 - 1 2 4 0 1 - 0 3 3 0 3 0 0

INTERNATIONAL APPROVALS FOR FLEXIBLE USE WORLDWIDE



DID YOU KNOW?

Every Murrelektronik connector is 100% tested.

This means:

- Electrically tested
- High voltage tested
- Performance tested
- Pin assignment tested
- Short circuit tested
- Visually controlled

YOUR BENEFITS

- **Modular connector program**
 - Find your connector quickly
- **International approvals**
 - Products approved for your market
- **Guaranteed quality**
 - 100% tested
 - All contacts gold-plated
 - High IP67 protection as standard
 - Shock and vibration resistant
- **Worldwide and industry wide**
 - Benefit from our expertise and our cross-industry expertise



AUDIBLY SEALED – SIMPLE AND SAFE

Our torque wrench connects Murrelektronik M8-, M12-, 7/8" and M23 connectors simply and tightly, leaving no room for error.

click
click
click

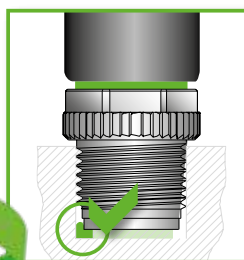

M8	0.4 Nm
M12	0.6 Nm
7/8"	1.5 Nm
M23	2.0 Nm

Just turn until you hear the click.

No more sore fingers!

STANDARD CABLE TYPES FOR YOUR APPLICATION



WIDE RANGE MEETS YOUR REQUIREMENTS

- **4 standard cable types for your application solution**
 - Always the right cable
- **3 cable colors (yellow, gray and black)**
 - The color you need for your industry
- **Meets the highest quality requirements**
 - Certified, application approved and successfully tested with many aggressive media (oil and lubricants)



Cable Types		PVC	PUR/PVC	PUR	PUR Welding Spark Resistant
Cable Standard		★	★★	★★★	★★★★★
Properties*	Flame retardant	■	■	■	■
	Resistant to chemicals	■	■	■	■
	Resistant to cleaning agents (Ecolab)	■			
	Resistant to oil and lubricants		■	■	■
	Suitable for use in Ctracks**		2 million	5 million	10 million
	Suitable for robotic applications			±180°	±360°
	Welding spark resistant				■
	UV resistant			■	■
	Halogen-free			■	■
	Varying temperatures	-5...+80 °C	-5...+80 °C	-25...+80 °C	-25...+90 °C
	UL/CSA approvals	■		■	■
Compliant with NFPA 79 Edition 2012	■		■		
Application Examples		Packaging machines Food & Beverage Assembly lines Production lines	Packaging machines Handling machines Assembly lines Production lines	Machine tools Swivel tables Metal cutting	Machine tools Industrial robots Metal cutting High performance Ctracks

* The properties of some cable types may differ from this data.

** Max. 3.3 m/s at 5 m horizontal travel distance and max. acceleration of 5 m/s².



M8 ROUND PLUG CONNECTORS

SMALL, LIGHT, MEETS YOUR NEEDS

- Extensive selection
- Tested technology
- Modern design

M8 REDESIGN – MORE MODELS, & NEW DESIGN

M8's redesign introduces new innovations. We completely redesigned all Murrelektronik's molded M8 connectors. They now have a new look and have been upgraded. We also significantly expanded our range of shielded M8 connectors.





Features:

- Durable PUR molding
- Gold plated contacts
- Small dimensions and improved feel
- Corrugated tubing connection
- Hex screw with thread (SW9)



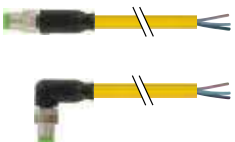



Huge Variety:

- Male/female, straight/90°, 3-pole/4-pole
- Shielded and unshielded connectors
- 3 standard colors, 4 standard cable types
- Cables, open ended wires, T-couplers, adapters, models with LED

With Open Ended Wires

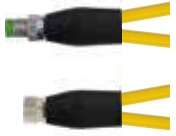
 <p>M8 male</p> <ul style="list-style-type: none"> • Straight • 90° <p style="text-align: right;"><i>Page 3.1.1</i></p>	 <p>M8 female</p> <ul style="list-style-type: none"> • Straight • 90° • 90° with LED <p style="text-align: right;"><i>Page 3.1.3</i></p>
 <p>M8 male (shielded)</p> <ul style="list-style-type: none"> • Straight • 90° <p style="text-align: right;"><i>Page 3.1.6</i></p>	 <p>M8 female (shielded)</p> <ul style="list-style-type: none"> • Straight • 90° <p style="text-align: right;"><i>Page 3.1.8</i></p>

Connection Cables

		<p>M8 male • Straight</p>	<p>M8 female • Straight • 90° • 90° with LED</p>
		<p>Y connector M8 • Male straight</p> <p>Y connector M8 • Female straight</p>	<p>M8 female • Straight</p> <p>M8 male • Straight</p>
		<p>M8 male (shielded) • Straight</p>	<p>M8 female (shielded) • Straight • 90°</p>

Field-Wireable

	<p>Insulation Displacement Technology (IDC) 0.14...0.34 mm²</p>	<p>M8 male/female • Straight</p>
	<p>Screw terminals</p>	<p>M8 male/female • Straight</p>
	<p>Screw terminals (shielded)</p>	<p>M8 male/female • Straight</p>

M8 ROUND PLUG CONNECTORS

With open ended wires

Male
straight



* only for products with UL/CSA approved cable

1 Form	08001	me	08011	me		
Type	3-pole		4-pole			
Circuit diagram						
Contact layout						
2 Cable Type	Jacket Color		Jacket Color			
Wire diameter 0.25 mm ²	yellow	gray	black	yellow	gray	black
PVC (UL/CSA)	010	210	610	011	211	611
PUR/PVC (UL/CSA)	020	220	620	021	221	621
PUR (UL/CSA), robots/C-tracks	030	230	630	031	231	631
PUR (UL/CSA), welding spark	050	250	650	051	251	651
3 Cable Length						
1.5 m	0150					
3.0 m	0300					
5.0 m	0500					
7.5 m	0750					
10.0 m	1000					
Technical Data						
Operating voltage	max. 50 V AC/60 V DC					
Protection	IP65, IP66K, IP67 inserted and tightened (EN 60529)					
Temperature range	-25...+85 °C, depending on cable quality					
Article No.						
The composition of your article number is explained on page 3.1.i	7 0 0 0 - - - - -					
	7 0 0 5 M8 Lite (plastic hexagonal screw) on request					
	1 Form		2 Cable Type		3 Cable Length	
Notes	Other versions on request. Differing cable lengths up to 2 m can be ordered in 0.2 m steps, from 2 m on in 0.5 m steps.					

M8 ROUND PLUG CONNECTORS

With open ended wires

Male
90°

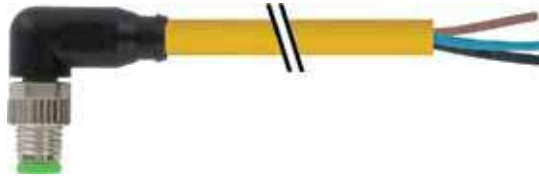

* only for products with UL/CSA approved cable

M8 Round Plug Connectors

1 Form	08021	meX	08031	meX					
Type	3-pole		4-pole						
Circuit diagram									
Contact layout									
2 Cable Type	Jacket Color			Jacket Color					
Wire diameter 0.25 mm ²	yellow	gray	black	yellow	gray	black			
PVC (UL/CSA)	010	210	610	011	211	611			
PUR/PVC (UL/CSA)	020	220	620	021	221	621			
PUR (UL/CSA), robots/C-tracks	030	230	630	031	231	631			
PUR (UL/CSA), welding spark	050	250	650	051	251	651			
3 Cable Length									
1.5 m	0150								
3.0 m	0300								
5.0 m	0500								
7.5 m	0750								
10.0 m	1000								
Technical Data									
Operating voltage	max. 50 V AC/60 V DC								
Protection	IP65, IP66K, IP67 inserted and tightened (EN 60529)								
Temperature range	-25...+85 °C, depending on cable quality								
Article No.									
The composition of your article number is explained on page 3.1.i	7 0 0 0			-		-		-	
	7 0 0 5			M8 Lite (plastic hexagonal screw) on request					
	1 Form		2 Cable Type		3 Cable Length				
Notes	Other versions on request. Differing cable lengths up to 2 m can be ordered in 0.2 m steps, from 2 m on in 0.5 m steps.								

M8 ROUND PLUG CONNECTORS

With open ended wires

Female
straight



* only for products with UL/CSA approved cable

M8 Round Plug Connectors

1 Form	08041	me	08061	me		
Type	3-pole		4-pole			
Circuit diagram						
Contact layout	<p>Female</p>		<p>Female</p>			
2 Cable Type	Jacket Color			Jacket Color		
Wire diameter 0.25 mm ²	yellow	gray	black	yellow	gray	black
PVC (UL/CSA)	010	210	610	011	211	611
PUR/PVC (UL/CSA)	020	220	620	021	221	621
PUR (UL/CSA), robots/C-tracks	030	230	630	031	231	631
PUR (UL/CSA), welding spark	050	250	650	051	251	651
3 Cable Length						
1.5 m	0150					
3.0 m	0300					
5.0 m	0500					
7.5 m	0750					
10.0 m	1000					
Technical Data						
Operating voltage	max. 50 V AC/60 V DC					
Protection	IP65, IP66K, IP67 inserted and tightened (EN 60529)					
Temperature range	-25...+85 °C, depending on cable quality					
Article No.						
The composition of your article number is explained on page 3.1.i	7 0 0 0 - - - - -					
	7 0 0 5 M8 Lite (plastic hexagonal screw) on request					
	1 Form		2 Cable Type		3 Cable Length	
Notes	Other versions on request. Differing cable lengths up to 2 m can be ordered in 0.2 m steps, from 2 m on in 0.5 m steps.					

M8 ROUND PLUG CONNECTORS

With open ended wires

Female
90°



* only for products with UL/CSA approved cable

M8 Round Plug Connectors

1 Form	08081	meX	08101	meX					
Type	3-pole		4-pole						
Circuit diagram									
Contact layout									
2 Cable Type	Jacket Color			Jacket Color					
Wire diameter 0.25 mm ²	yellow	gray	black	yellow	gray	black			
PVC (UL/CSA)	010	210	610	011	211	611			
PUR/PVC (UL/CSA)	020	220	620	021	221	621			
PUR (UL/CSA), robots/C-tracks	030	230	630	031	231	631			
PUR (UL/CSA), welding spark	050	250	650	051	251	651			
3 Cable Length									
1.5 m	0150								
3.0 m	0300								
5.0 m	0500								
7.5 m	0750								
10.0 m	1000								
Technical Data									
Operating voltage	max. 50 V AC/60 V DC								
Protection	IP65, IP66K, IP67 inserted and tightened (EN 60529)								
Temperature range	-25...+85 °C, depending on cable quality								
Article No.									
The composition of your article number is explained on page 3.1.i	7 0 0 0			-		-		-	
	7 0 0 5			M8 Lite (plastic hexagonal screw) on request					
	1 Form		2 Cable Type		3 Cable Length				
Notes	Other versions on request. Differing cable lengths up to 2 m can be ordered in 0.2 m steps, from 2 m on in 0.5 m steps.								

M8 ROUND PLUG CONNECTORS

With open ended wires

Female
90° with LED



* only for products with UL/CSA approved cable

M8 Round Plug Connectors

1 Form	08121	me	08141			
Type	3-pole with 2 × LED (PNP) (NPN) on request		4-pole with 3 × LED (PNP) (NPN) on request			
Circuit diagram						
Contact layout	<p>Female</p>		<p>Female</p>			
2 Cable Type	Jacket Color		Jacket Color			
Wire diameter 0.25 mm ²	yellow	gray	black	yellow	gray	black
PVC (UL/CSA)	010	210	610	011	211	611
PUR/PVC (UL/CSA)	020	220	620	021	221	621
PUR (UL/CSA), robots/C-tracks	030	230	630	031	231	631
PUR (UL/CSA), welding spark	050	250	650	051	251	651
3 Cable Length						
1.5 m	0150					
3.0 m	0300					
5.0 m	0500					
7.5 m	0750					
10.0 m	1000					
Technical Data						
Operating voltage	24 V DC ±25%					
Protection	IP65, IP66K, IP67 inserted and tightened (EN 60529)					
Temperature range	-25...+85 °C, depending on cable quality					
Article No.						
The composition of your article number is explained on page 3.1.i	<p>7 0 0 0 - - - - - - - - - -</p> <p>7 0 0 5 M8 Lite (plastic hexagonal screw) on request</p>					
	1 Form	2 Cable Type	3 Cable Length			
Notes	Other versions on request. Differing cable lengths up to 2 m can be ordered in 0.2 m steps, from 2 m on in 0.5 m steps.					

M8 ROUND PLUG CONNECTORS

With open ended wires

Male
straight



Approvals:

* only for products with UL/CSA approved cable

1 Form		08701	08711
Type		3-pole, shielded	4-pole, shielded
Circuit diagram			
Contact layout		<p>Male</p>	<p>Male</p>
2 Cable Type	Wire diameter 0.34 mm ² PVC (UL/CSA) PUR (UL/CSA), robots/C/tracks	Jacket Color	
		gray	black
		200 240	600 640
		gray	black
		201 241	601 641
3 Cable Length			
1.5 m		0150	
3.0 m		0300	
5.0 m		0500	
7.5 m		0750	
10.0 m		1000	
Technical Data			
Operating voltage	max. 50 V AC/60 V DC		
Protection	IP65, IP66K, IP67 inserted and tightened (EN 60529)		
Temperature range	-25...+85 °C, depending on cable quality		
Article No.			
The composition of your article number is explained on page 3.1.i	<div style="display: flex; justify-content: space-around; align-items: center;"> 7 0 0 0 - - </div>		
	1	2	3
	Form	Cable Type	Cable Length
Notes			
Other versions on request. Differing cable lengths up to 2 m can be ordered in 0.2 m steps, from 2 m on in 0.5 m steps.			

M8 Round Plug Connectors

M8 ROUND PLUG CONNECTORS

With open ended wires

Male

90°



* only for products with UL/CSA approved cable

1 Form	08721	08731
Type	3-pole, shielded	4-pole, shielded
Circuit diagram		
Contact layout	<p>Male</p>	<p>Male</p>
2 Cable Type	Jacket Color	Jacket Color
Wire diameter 0.34 mm ²	gray	black
PVC (UL/CSA)	200	600
PUR (UL/CSA), robots/Ctracks	240	640
3 Cable Length		
1.5 m	0150	
3.0 m	0300	
5.0 m	0500	
7.5 m	0750	
10.0 m	1000	
Technical Data		
Operating voltage	max. 50 V AC/60 V DC	
Protection	IP65, IP66K, IP67 inserted and tightened (EN 60529)	
Temperature range	-25...+85 °C, depending on cable quality	
Article No.		
The composition of your article number is explained on page 3.1.i	<p>7 0 0 0 - - - - - - - - - -</p>	
	1 Form	2 Cable Type 3 Cable Length
Notes	Other versions on request. Differing cable lengths up to 2 m can be ordered in 0.2 m steps, from 2 m on in 0.5 m steps.	

M8 ROUND PLUG CONNECTORS

With open ended wires

Female
straight



Approvals:

* only for products with UL/CSA approved cable

1 Form	08741	08761
	Type	3-pole, shielded
Circuit diagram		
Contact layout	<p>Female</p>	<p>Female</p>
2 Cable Type	Jacket Color	
Wire diameter 0.34 mm ²	gray	black
PVC (UL/CSA)	200	600
PUR (UL/CSA), robots/Ctracks	240	640
3 Cable Length		
1.5 m	0150	
3.0 m	0300	
5.0 m	0500	
7.5 m	0750	
10.0 m	1000	
Technical Data		
Operating voltage	max. 50 V AC/60 V DC	
Protection	IP65, IP66K, IP67 inserted and tightened (EN 60529)	
Temperature range	-25...+85 °C, depending on cable quality	
Article No.		
The composition of your article number is explained on page 3.1.i	<div style="display: flex; justify-content: space-around; align-items: center;"> 7 0 0 0 - _ _ _ - _ _ _ </div>	
	1 Form	2 Cable Type
		3 Cable Length
Notes	Other versions on request. Differing cable lengths up to 2 m can be ordered in 0.2 m steps, from 2 m on in 0.5 m steps.	

M8 ROUND PLUG CONNECTORS

With open ended wires

Female

90°



* only for products with UL/CSA approved cable

1 Form		08781	08801
Type		3-pole, shielded	4-pole, shielded
Circuit diagram			
Contact layout		<p>Female</p>	<p>Female</p>
2 Cable Type		Jacket Color	Jacket Color
Wire diameter 0.34 mm ²		gray	black
PVC (UL/CSA)		200	600
PUR (UL/CSA), robots/Ctracks		240	640
3 Cable Length			
1.5 m		0150	
3.0 m		0300	
5.0 m		0500	
7.5 m		0750	
10.0 m		1000	
Technical Data			
Operating voltage		max. 50 V AC/60 V DC	
Protection		IP65, IP66K, IP67 inserted and tightened (EN 60529)	
Temperature range		-25...+85 °C, depending on cable quality	
Article No.			
The composition of your article number is explained on page 3.1.i		7 0 0 0	- - - - -
		1 Form	2 Cable Type 3 Cable Length
Notes		Other versions on request. Differing cable lengths up to 2 m can be ordered in 0.2 m steps, from 2 m on in 0.5 m steps.	

M8 ROUND PLUG CONNECTORS

Connection cables

– M8 - M8



* only for products with UL/CSA approved cable

Male

straight

Female

straight



1 Form	88001	meX	88011	meX		
Type	3-pole		4-pole			
Circuit diagram						
Contact layout						
2 Cable Type	Jacket Color			Jacket Color		
Wire diameter 0.25 mm ²	yellow	gray	black	yellow	gray	black
PVC (UL/CSA)	010	210	610	011	211	611
PUR/PVC (UL/CSA)	020	220	620	021	221	621
PUR (UL/CSA), robots/C-tracks	030	230	630	031	231	631
PUR (UL/CSA), welding spark	050	250	650	051	251	651
3 Cable Length						
0.3 m	0030					
0.6 m	0060					
1.0 m	0100					
1.5 m	0150					
2.0 m	0200					
Technical Data						
Operating voltage	max. 50 V AC/60 V DC					
Protection	IP65, IP66K, IP67 inserted and tightened (EN 60529)					
Temperature range	-25...+85 °C, depending on cable quality					
Article No.						
The composition of your article number is explained on page 3.1.i	7 0 0 0		-		-	
	7 0 0 5		M12 Lite (plastic hexagonal screw) on request			
	1 Form		2 Cable Type		3 Cable Length	
Notes	Other versions on request. Differing cable lengths up to 2 m can be ordered in 0.2 m steps, from 2 m on in 0.5 m steps.					

M8 ROUND PLUG CONNECTORS

Connection cables

- M8 - M8

Male
straight

Female
90°



* only for products with UL/CSA approved cable

1 Form		88 021 me \times			88 031 me \times		
Type	3-pole				4-pole		
Circuit diagram							
Contact layout	<p>Male</p> <p>Female</p>				<p>Male</p> <p>Female</p>		
2 Cable Type		Jacket Color			Jacket Color		
Wire diameter 0.25 mm ²	yellow	gray	black	yellow	gray	black	
PVC (UL/CSA)	010	210	610	011	211	611	
PUR/PVC (UL/CSA)	020	220	620	021	221	621	
PUR (UL/CSA), robots/C-tracks	030	230	630	031	231	631	
PUR (UL/CSA), welding spark	050	250	650	051	251	651	
3 Cable Length							
0.3 m	0030						
0.6 m	0060						
1.0 m	0100						
1.5 m	0150						
2.0 m	0200						
Technical Data							
Operating voltage	max. 50 V AC/60 V DC						
Protection	IP65, IP66K, IP67 inserted and tightened (EN 60529)						
Temperature range	-25...+85 °C, depending on cable quality						
Article No.							
The composition of your article number is explained on page 3.1.i	7 0 0 0 - - - - -						
	7 0 0 5 M8 Lite (plastic hexagonal screw) on request						
		1 Form		2 Cable Type		3 Cable Length	
Notes							
		Other versions on request. Differing cable lengths up to 2 m can be ordered in 0.2 m steps, from 2 m on in 0.5 m steps.					

M8 ROUND PLUG CONNECTORS

Connection cables

– M8 - M8



* only for products with UL/CSA approved cable

Male

straight

Female

90° with LED



1 Form

88041

mex

Type

3-pole with 2 × LED (PNP)

(NPN) on request

Circuit diagram

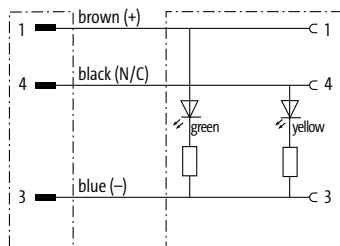

Contact layout

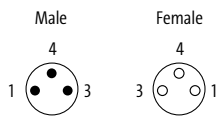

2 Cable Type

Jacket Color

Wire diameter 0.25 mm ²	yellow	gray	black
PVC (UL/CSA)	010	210	610
PUR/PVC (UL/CSA)	020	220	620
PUR (UL/CSA), robots/C-tracks	030	230	630
PUR (UL/CSA), welding spark	050	250	650

3 Cable Length

0.3 m	0030
0.6 m	0060
1.0 m	0100
1.5 m	0150
2.0 m	0200

Technical Data

Operating voltage	24 V DC ±25%
Protection	IP65, IP66K, IP67 inserted and tightened (EN 60529)
Temperature range	-25...+85 °C, depending on cable quality

Article No.

The composition of your article number is explained on page 3.1.i

7 0 0 0

-

8 8 0 4 1

-

7 0 0 5

M8 Lite (plastic hexagonal screw) on request

1

Form

2

Cable Type

3

Cable Length

Notes

Other versions on request. Differing cable lengths up to 2 m can be ordered in 0.2 m steps, from 2 m on in 0.5 m steps.

M8 ROUND PLUG CONNECTORS

Connection cables

– M8 - M8

Y connector

Male straight

Females

straight

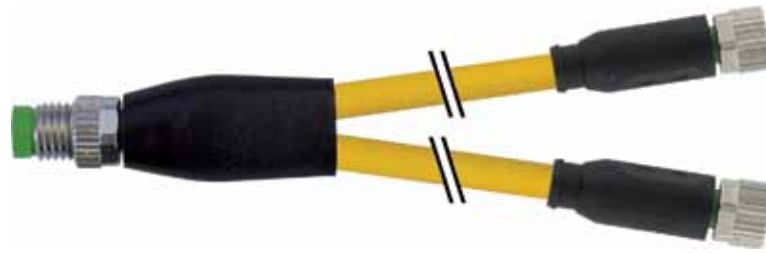

1 Form		87001	87011			
Type		4-/3-pole	3-pole			
Circuit diagram						
Contact layout						
2 Cable Type	Jacket Color	Jacket Color				
Wire diameter 0.25 mm ²	yellow	gray	black	yellow	gray	black
PVC (UL/CSA)	010	210	610	010	210	610
PUR/PVC (UL/CSA)	020	220	620	020	220	620
PUR (UL/CSA), robots/C-tracks	030	230	630	030	230	630
PUR (UL/CSA), welding spark	050	250	650	050	250	650
3 Cable Length						
0.3 m	0030					
0.6 m	0060					
1.0 m	0100					
1.5 m	0150					
2.0 m	0200					
Technical Data						
Operating voltage	max. 50 V AC/60 V DC					
Protection	IP65, IP66K, IP67 inserted and tightened (EN 60529)					
Temperature range	-25...+85 °C, depending on cable quality					
Article No.						
The composition of your article number is explained on page 3.1.i	<div style="display: flex; justify-content: space-around; align-items: center;"> 7 0 0 0 - </div>					
	<div style="display: flex; justify-content: space-around; align-items: center;"> 7 0 0 5 M8 Lite (plastic hexagonal screw) on request </div>					
	1	2	3	Form	Cable Type	Cable Length
Notes	Other versions on request. Differing cable lengths up to 2 m can be ordered in 0.2 m steps, from 2 m on in 0.5 m steps.					

M8 ROUND PLUG CONNECTORS

Connection cables

– M8 - M8

Y connector

Male straight

Females

straight

Y connector

Female straight

Male

straight



1 Form

87061

87251

Type
Circuit diagram

4-pole

4-/3-pole

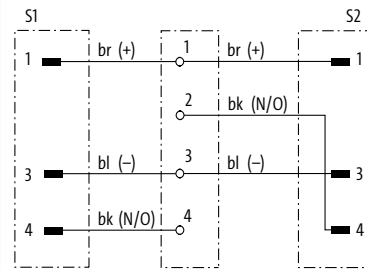
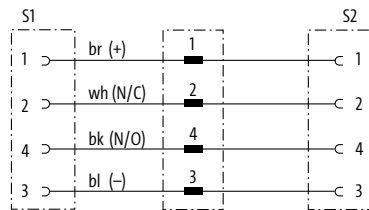

Contact layout

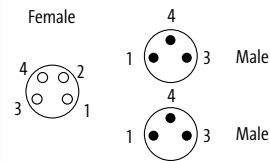
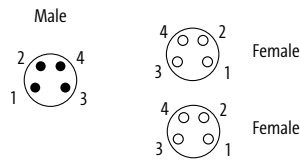

2 Cable Type

Jacket Color

Jacket Color

Wire diameter 0.25 mm²

	yellow	gray	black	yellow	gray	black
PVC (UL/CSA)	011	211	611	010	210	610
PUR/PVC (UL/CSA)	021	221	621	020	220	620
PUR (UL/CSA), robots/C-tracks	031	231	631	030	230	630
PUR (UL/CSA), welding spark	051	251	651	050	250	650

3 Cable Length

0.3 m	0030
0.6 m	0060
1.0 m	0100
1.5 m	0150
2.0 m	0200

Technical Data

Operating voltage	max. 50 V AC/60 V DC
Protection	IP65, IP66K, IP67 inserted and tightened (EN 60529)
Temperature range	-25...+85 °C, depending on cable quality

Article No.

The composition of your article number is explained on page 3.1.i

7 0 0 0

7 0 0 5

M8 Lite (plastic hexagonal screw) on request

1

Form

2

Cable Type

3

Cable Length

Notes

Other versions on request. Differing cable lengths up to 2 m can be ordered in 0.2 m steps, from 2 m on in 0.5 m steps.

M8 ROUND PLUG CONNECTORS

Connection cables

– M8 - M8

Male

straight

Female

straight



* only for products with UL/CSA approved cable

1 Form		89501	89511
Type		3-pole, shielded	4-pole, shielded
Circuit diagram			
Contact layout			
2 Cable Type		Jacket Color	Jacket Color
Wire diameter 0.34 mm ²		gray	black
PVC (UL/CSA)		200	600
PUR (UL/CSA), robots/Ctracks		240	640
3 Cable Length			
0.3 m		0030	
0.6 m		0060	
1.0 m		0100	
1.5 m		0150	
2.0 m		0200	
Technical Data			
Operating voltage		max. 50 V AC/60 V DC	
Protection		IP65, IP66K, IP67 inserted and tightened (EN 60529)	
Temperature range		-25...+85 °C, depending on cable quality	
Article No.			
The composition of your article number is explained on page 3.1.i		7 0 0 0	
		1 Form	2 Cable Type
			3 Cable Length
Notes		Other versions on request. Differing cable lengths up to 2 m can be ordered in 0.2 m steps, from 2 m on in 0.5 m steps.	

M8 ROUND PLUG CONNECTORS

Connection cables

– M8 - M8



* only for products with UL/CSA approved cable

Male

straight

Female

90°



1 Form

89521

89531

Type

3-pole, shielded

4-pole, shielded

Circuit diagram

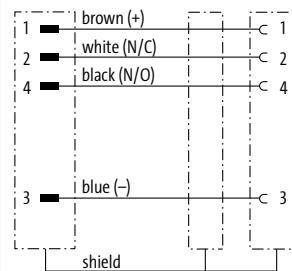
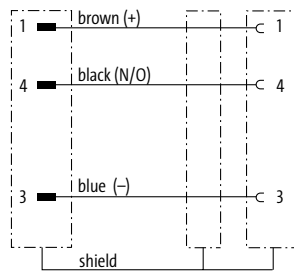

Contact layout

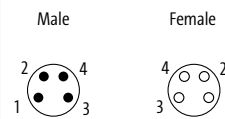
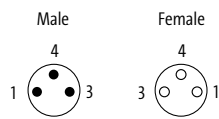

2 Cable Type

Jacket Color

Jacket Color

Wire diameter 0.34 mm²

PVC (UL/CSA)

PUR (UL/CSA), robots/Ctracks

	gray	black
	200	600
	240	640

	gray	black
	201	601
	241	641

3 Cable Length

0.3 m	0030
0.6 m	0060
1.0 m	0100
1.5 m	0150
2.0 m	0200

Technical Data

Operating voltage	max. 50 V AC/60 V DC
Protection	IP65, IP66K, IP67 inserted and tightened (EN 60529)
Temperature range	-25...+85 °C, depending on cable quality

Article No.

The composition of your article number is explained on page 3.1.i

7 0 0 0 - - - - -

1 Form

2 Cable Type

3 Cable Length

Notes

Other versions on request. Differing cable lengths up to 2 m can be ordered in 0.2 m steps, from 2 m on in 0.5 m steps.

M8 ROUND PLUG CONNECTORS

Field-wireable

– IDC terminals

Male

straight



Female

straight



Approvals:

M8 Round Plug Connectors

1 Form	08331 me*	08351 me*	08371 me*	08391 me*
Type	3-pole	4-pole	3-pole	4-pole
Circuit diagram				
Connection cross section	0.14...0.34 mm ²			
Contact layout				
Technical Data				
Operating voltage	max. 32 V AC/DC			
Rated surge voltage	0.8 kV			
Operating current per contact	max. 4 A			
Configuration	fully used			
Material group	IEC 60664-1, category I			
Over voltage category	3			
Isolation resistance	≥ 10 ⁸ Ohm			
Contact resistance	≤ 10 mOhm			
Connection cross section	0.14...0.34 mm ² (conductor diameter min. 0.1 mm)			
Sealing range (cable Ø)	2.5...5.1 mm (gasket included)			
Outer wire Ø	1.0...1.6 mm			
Locking of ports	Screw thread M8 × 1 mm (recommended torque 0.4 Nm) self-securing			
Compression gland	M8 (SW9)			
Protection	IP67 inserted and tightened (EN 60529)			
Wire isolation	PVC, PP, TPE			
Material	PA			
Locking material	Zinc die casting, matte nickel plated			
Mating cycles	≥ 100			
Reconnection (cable)	10			
Temperature range	-25...+85 °C			
Article No.				
The composition of your article number is explained on page 3.1.i	<u>7</u> <u>0</u> <u>0</u> <u>0</u>	-	<u>0</u> <u>0</u> <u>0</u>	<u>0</u> <u>0</u> <u>0</u> <u>0</u>
	1 Form			
Notes	Other versions on request.			

M8 ROUND PLUG CONNECTORS

Field-wireable
– Screw terminals

Male
straight

Female
straight



Approvals:

M8 Round Plug Connectors

1 Form	08601 me*	08611 me*	08621 me*	08631 me*
Type	3-pole	4-pole	3-pole	4-pole
Circuit diagram				
Connection cross section	0.14...0.5 mm ²			
Contact layout	<p>Male</p>	<p>Male</p>	<p>Female</p>	<p>Female</p>
Technical Data				
Operating voltage	max. 60 V AC/DC	max. 30 V AC/DC	max. 60 V AC/DC	max. 30 V AC/DC
Rated surge voltage	1.5 kV	0.8 kV	1.5 kV	0.8 kV
Operating current per contact	max. 4 A			
Connection cross section	0.14...0.5 mm ²			
Sealing range (cable Ø)	2.5...5.0 mm			
Protection	IP67 inserted and tightened (EN 60529)			
Temperature range	-25...+85 °C			
Article No.				
The composition of your article number is explained on page 3.1.i	<u>7</u> <u>0</u> <u>0</u> <u>0</u>	-	-	<u>0</u> <u>0</u> <u>0</u> <u>0</u>
	1 Form			
Notes	Other versions on request.			

M8 ROUND PLUG CONNECTORS

Field-wireable

– Screw terminals

Male

straight



Female

straight





M8 Round Plug Connectors

1 Form	08641 me✘	08651 me✘	08661 me✘	08671 me✘
Type	3-pole, shielded	4-pole, shielded	3-pole, shielded	4-pole, shielded
Circuit diagram				
Connection cross section	0.14...0.5 mm ²			
Contact layout	<p>Male</p>	<p>Male</p>	<p>Female</p>	<p>Female</p>
Technical Data				
Operating voltage	max. 50 V AC/60 V DC	max. 30 V AC/DC	max. 60 V AC/DC	max. 30 V AC/DC
Rated surge voltage	1.5 kV	0.8 kV	1.5 kV	0.8 kV
Operating current per contact	max. 4 A			
Material group	IEC 60664-1, category III			
Connection cross section	0.14...0.5 mm ²			
Sealing range (cable Ø)	3.5...5.5 mm			
Locking of ports	Screw thread M8 × 1 mm (recommended torque 0.4 Nm) self-securing			
Protection	IP67 inserted and tightened (EN 60529)			
Locking material	Brass, nickel plated			
Temperature range	-25...+85 °C			
Article No.				
The composition of your article number is explained on page 3.1.i	<u>7</u> <u>0</u> <u>0</u> <u>0</u>	-	-	<u>0</u> <u>0</u> <u>0</u> <u>0</u>
	1 Form			
Notes	Other versions on request.			

M8 ROUND PLUG CONNECTORS

Labeling accessories			Art-No.
	Slip-on cable sleeve for ACS label plates (4 × 18 mm)	Cable diameter (4...6.5 mm)	7000-99004-000000
	Snap-on cable sleeve for ACS label plates (4 × 18 mm) for ACS label plates (4 × 18 mm)	Cable diameter (4.2...5.6 mm) Cable diameter (5...7 mm)	7000-99005-000000 7000-99006-000000
	ACS label plate for self marking (4 × 18 mm)		7000-99002-000000
	Colored ring M8/M12 sandy yellow zinc yellow redorange red violet purple blue green gray white black	for unshielded molding for unshielded molding for unshielded molding for unshielded molding for unshielded molding for unshielded molding for unshielded molding for unshielded molding for unshielded molding for unshielded molding for unshielded molding	7000-99301-V011002 7000-99301-V011018 7000-99301-V012008 7000-99301-V013020 7000-99301-V014003 7000-99301-V014006 7000-99301-V015005 7000-99301-V016018 7000-99301-V017035 7000-99301-V019003 7000-99301-V019004
Mounting accessories			Art-No.
	Torque wrench set M8 (0.4 Nm, SW9)	M8 data connectors	7000-99101-000000
	Torque wrench M8 (0.4 Nm, SW9)	M8 data connectors	7000-99091-000000
End fitting accessories			Art-No.
	Tube adapter snap-in for corrugated tube (size 13mm)	Cable diameter (4...7 mm)	7000-99081-000000
	Gasket MOSA M8		7000-99008-000000

M8 ROUND PLUG CONNECTORS

Connection accessories				Art-No.
	Universal holder modular	M8 M12	7000-99801-0000000	
	Flange M8 male, pre-wired 0.2 m suitable for mounting with wall thickness suitable for mounting with wall thickness	max. 4.5 mm max. 4.5 mm	7000-08552-9700020 7000-08562-9690020	
	Flange M8 female, pre-wired 0.2 m straight, A-coded, 3-pole	7000-08571-9700020 7000-08581-9710020		

M8 Round Plug Connectors



M12 ROUND PLUG CONNECTORS COMPREHENSIVE AND VERSATILE

- The right model for any application
- Shock and vibration resistant with integrated fastening
- Reliable – 100% tested

M12 CONNECTORS – DESIGNED FOR MANY DIFFERENT CUSTOMER APPLICATIONS

Murrelektronik offers one of the most comprehensive M12 connector ranges on the market. Reliable, quick and easy assembly, a clear LED indicator: these are only a few of the features that make this product range one of the best.

Features

- Combined hex screw with thread for secure connections
- Highly resistant, halogen-free PUR molding guarantees IP67/68 seal
- Wide range of cable material and color – always the right choice for your application

With Open Ended Wires

 <p>M12 male</p> <ul style="list-style-type: none"> • Straight • 90° <p><i>Page 3.2.1</i></p>	 <p>M12 female</p> <ul style="list-style-type: none"> • Straight • 90° <p><i>Page 3.2.7</i></p>
 <p>M12 female with LED</p> <ul style="list-style-type: none"> • Straight • 90° <p><i>Page 3.2.13</i></p>	 <p>M12 male (shielded)</p> <ul style="list-style-type: none"> • Straight • 90° <p><i>Page 3.2.17</i></p>
 <p>M12 female (shielded)</p> <ul style="list-style-type: none"> • Straight • 90° <p><i>Page 3.2.23</i></p>	

Connection Cables

		<p>M12 male</p> <ul style="list-style-type: none"> • Straight • 90° 	<p>M12 female</p> <ul style="list-style-type: none"> • Straight • 90° • 90° with LED <p><i>Page 3.2.29</i></p>
		<p>M12 Y connector male</p> <ul style="list-style-type: none"> • Straight 	<p>M12 female</p> <ul style="list-style-type: none"> • Straight • 90° • 90° with LED <p><i>Page 3.2.35</i></p>
		<p>M12 male (shielded)</p> <ul style="list-style-type: none"> • Straight 	<p>M12 female (shielded)</p> <ul style="list-style-type: none"> • Straight <p><i>Page 3.2.38</i></p>

Field-Wireable

	<p>Insulation Displacement Technology (IDC)</p>	<p>M12 male/female</p> <ul style="list-style-type: none"> • Straight • 90° <p>M12 female</p> <ul style="list-style-type: none"> • 90° with LED <p><i>Page 3.2.41</i></p>	
	<p>Screw terminals</p> <p>Screw terminals</p>	<p>M12 male/female</p> <ul style="list-style-type: none"> • Straight • 90° <p>M12 Y connector male</p> <ul style="list-style-type: none"> • Straight <p><i>Page 3.2.47</i></p>	
	<p>Screw terminals (shielded)</p>	<p>M12 male/female</p> <ul style="list-style-type: none"> • Straight • 90° <p><i>Page 3.2.54</i></p>	

M12 ROUND PLUG CONNECTORS

With open ended wires

Male
straight



* only for products with UL/CSA approved cable

1 Form	12001 me	12021 me	12041 me						
Type	3-pole	4-pole	5-pole						
Circuit diagram			<p>(* for cable type 126, 732, 219, 619)</p>						
Contact layout	<p>Male</p>	<p>Male</p>	<p>Male</p>						
2 Cable Type	Jacket Color								
Wire diameter 0.34 mm ²	yellow	gray	black	yellow	gray	black	yellow	gray	black
PVC (UL/CSA)	013	213	613	014	214	614	015	215 (219)	615 (619)
PUR/PVC (UL/CSA)	023	223	623	024	224	624	025	225	625
PUR (UL/CSA), robots/C-tracks	033	233	633	034	234	634	035 (126)	235	635 (732)
PUR (UL/CSA), welding spark	053	253	653	054	254	654	055	255	655
3 Cable Length									
1.5 m	0150								
3.0 m	0300								
5.0 m	0500								
7.5 m	0750								
10.0 m	1000								
Technical Data									
Operating voltage	max. 250 V AC/DC						max. 125 V AC/DC		
Protection	IP65, IP66K, IP67 inserted and tightened (EN 60529)								
Temperature range	-25...+85 °C, depending on cable quality								
Article No.									
The composition of your article number is explained on page 3.1.i	<div style="display: flex; justify-content: space-around; align-items: center;"> 7 0 0 0 - _ _ _ _ _ _ _ _ _ </div>								
	<div style="display: flex; justify-content: space-around; align-items: center;"> 7 0 0 5 - _ _ _ _ _ _ _ _ </div> <p>M12 Lite (plastic hexagonal screw) on request</p>								
	1 Form			2 Cable Type			3 Cable Length		
Notes	Other versions on request. Differing cable lengths up to 2 m can be ordered in 0.2 m steps, from 2 m on in 0.5 m steps.								

M12 Round Plug Connectors

M12 ROUND PLUG CONNECTORS

With open ended wires

Male
straight



Approvals:  

* only for products with UL/CSA approved cable

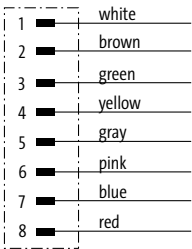
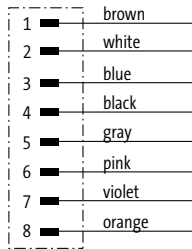
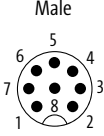
1 Form	170 01	170 01
	8-pole	8-pole
Circuit diagram		
Contact layout	<p>Male</p> 	
2 Cable Type	Jacket Color	Jacket Color
Wire diameter 0.25 mm ²	gray black yellow	gray black
PVC (UL/CSA)	207 607	208 608
PUR (UL/CSA), robots/C/tracks	292 722 114	295
3 Cable Length		
1.5 m	0150	
3.0 m	0300	
5.0 m	0500	
7.5 m	0750	
10.0 m	1000	
Technical Data		
Operating voltage	max. 30 V AC/DC	
Protection	IP65, IP66K, IP67 inserted and tightened (EN 60529)	
Temperature range	-25...+85 °C, depending on cable quality	
Article No.		
The composition of your article number is explained on page 3.1.i	<u>7</u> <u>0</u> <u>0</u> <u>0</u> - - - - - - - - - -	- - - - -
	<u>7</u> <u>0</u> <u>0</u> <u>5</u> M12 Lite (plastic hexagonal screw) on request	
	1 Form	2 Cable Type
		3 Cable Length
Notes	Other versions on request. Differing cable lengths up to 2 m can be ordered in 0.2 m steps, from 2 m on in 0.5 m steps.	

M12 Round Plug Connectors

M12 ROUND PLUG CONNECTORS

With open ended wires

Male

straight

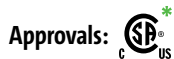

* only for products with UL/CSA approved cable

1 Form		19001	
Type	12-pole		
Circuit diagram			
Contact layout	<p>Male</p>		
2 Cable Type		Jacket Color	
Wire diameter 0.14 mm ²		gray	black
PVC (UL/CSA)		209	609
PUR (UL/CSA), robots/C-tracks			705
Wire diameter 0.25 mm ²			
PUR (UL/CSA), robots/C-tracks		301	
PUR (UL/CSA), welding spark		302	
3 Cable Length			
1.5 m	0150		
3.0 m	0300		
5.0 m	0500		
7.5 m	0750		
10.0 m	1000		
Technical Data			
Operating voltage	max. 30 V AC/DC		
Protection	IP65, IP66K, IP67 inserted and tightened (EN 60529)		
Temperature range	-25...+85 °C, depending on cable quality		
Article No.			
The composition of your article number is explained on page 3.1.i	7 0 0 0 - 1 9 0 0 1 - _ _ _		
	7 0 0 5 M12 Lite (plastic hexagonal screw) on request		
	1 Form	2 Cable Type	3 Cable Length
Notes	Other versions on request. Differing cable lengths up to 2 m can be ordered in 0.2 m steps, from 2 m on in 0.5 m steps.		

M12 ROUND PLUG CONNECTORS

With open ended wires

Male
90°



Approvals:

* only for products with UL/CSA approved cable

1 Form	12081 me \times	12101 me \times	12121 me \times						
Type	3-pole	4-pole	5-pole						
Circuit diagram			<p>(* for cable type 126, 732, 219, 619)</p>						
Contact layout									
2 Cable Type	Jacket Color								
Wire diameter 0.34 mm ²	yellow	gray	black	yellow	gray	black	yellow	gray	black
PVC (UL/CSA)	013	213	613	014	214	614	015	215 (219)	615 (619)
PUR/PVC (UL/CSA)	023	223	623	024	224	624	025	225	625
PUR (UL/CSA), robots/C-tracks	033	233	633	034	234	634	035 (126)	235	635 (732)
PUR (UL/CSA), welding spark	053	253	653	054	254	654	055	255	655
3 Cable Length									
1.5 m	0150								
3.0 m	0300								
5.0 m	0500								
7.5 m	0750								
10.0 m	1000								
Technical Data									
Operating voltage	max. 250 V AC/DC						max. 125 V AC/DC		
Protection	IP65, IP66K, IP67 inserted and tightened (EN 60529)								
Temperature range	-25...+85 °C, depending on cable quality								
Article No.									
The composition of your article number is explained on page 3.1.i	7 0 0 0 - - - - - - - - - -								
	7 0 0 5 M12 Lite (plastic hexagonal screw) on request								
	1 Form			2 Cable Type			3 Cable Length		
Notes	Other versions on request. Differing cable lengths up to 2 m can be ordered in 0.2 m steps, from 2 m on in 0.5 m steps.								

M12 Round Plug Connectors

M12 ROUND PLUG CONNECTORS

With open ended wires

Male
90°



* only for products with UL/CSA approved cable

1 Form	17021	17021											
	Type 8-pole	Type 8-pole											
	Circuit diagram	Circuit diagram											
Contact layout	<p>Male</p>												
2 Cable Type	Jacket Color	Jacket Color											
	Wire diameter 0.25 mm ² PVC (UL/CSA)	<table border="1"> <tr> <td>gray</td> <td>black</td> <td>yellow</td> </tr> <tr> <td>207</td> <td>607</td> <td></td> </tr> </table>	gray	black	yellow	207	607		<table border="1"> <tr> <td>gray</td> <td>black</td> </tr> <tr> <td>208</td> <td>608</td> </tr> </table>	gray	black	208	608
	gray	black	yellow										
207	607												
gray	black												
208	608												
PUR (UL/CSA), robots/Ctracks	<table border="1"> <tr> <td>292</td> <td>722</td> <td>114</td> </tr> </table>	292	722	114	<table border="1"> <tr> <td>295</td> <td></td> </tr> </table>	295							
292	722	114											
295													
3 Cable Length													
	1.5 m	0150											
	3.0 m	0300											
	5.0 m	0500											
	7.5 m	0750											
10.0 m	1000												
Technical Data													
	Operating voltage	max. 30 V AC/DC											
	Protection	IP65, IP66K, IP67 inserted and tightened (EN 60529)											
Temperature range	-25...+85 °C, depending on cable quality												
Article No.													
	<p>The composition of your article number is explained on page 3.1.i</p> <p>7 0 0 0 - - - - -</p> <p>7 0 0 5 M12 Lite (plastic hexagonal screw) on request</p>												
	1 Form	2 Cable Type	3 Cable Length										
Notes	Other versions on request. Differing cable lengths up to 2 m can be ordered in 0.2 m steps, from 2 m on in 0.5 m steps.												

M12 ROUND PLUG CONNECTORS

With open ended wires

Male

90°



Approvals: 

* only for products with UL/CSA approved cable

1 Form

19021

Type **12-pole**

Circuit diagram

1	brown
2	blue
3	white
4	green
5	pink
6	yellow
7	black
8	gray
9	red
10	violet
11	gray/pink
12	red/blue

Contact layout

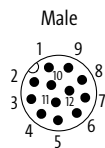

2 Cable Type

Jacket Color

Wire diameter 0.14 mm ²	gray	black
PVC (UL/CSA)	209	609
PUR (UL/CSA), robots/C-tracks		705
Wire diameter 0.25 mm ²		
PUR (UL/CSA), robots/C-tracks	301	
PUR (UL/CSA), welding spark	302	

3 Cable Length

1.5 m	0150
3.0 m	0300
5.0 m	0500
7.5 m	0750
10.0 m	1000

Technical Data

Operating voltage	max. 30 V AC/DC
Protection	IP65, IP66K, IP67 inserted and tightened (EN 60529)
Temperature range	-25...+85 °C, depending on cable quality

Article No.

The composition of your article number is explained on page 3.1.i

7 0 0 0 - 1 9 0 2 1 - _ _ _

7 0 0 5 M12 Lite (plastic hexagonal screw) on request

1 Form **2** Cable Type **3** Cable Length

Notes

Other versions on request. Differing cable lengths up to 2 m can be ordered in 0.2 m steps, from 2 m on in 0.5 m steps.

M12 ROUND PLUG CONNECTORS

With open ended wires

Female
straight



* only for products with UL/CSA approved cable

1 Form	12181	meX			12221	meX			12241
Type	3-pole				4-pole				5-pole
Circuit diagram									<p>(* for cable type 126, 732, 219, 619)</p>
Contact layout	<p>Female</p>				<p>Female</p>				<p>Female</p>
2 Cable Type	Jacket Color			Jacket Color			Jacket Color		
Wire diameter 0.34 mm ²	yellow	gray	black	yellow	gray	black	yellow	gray	black
PVC (UL/CSA)	013	213	613	014	214	614	015	215 (219)	615 (619)
PUR/PVC (UL/CSA)	023	223	623	024	224	624	025	225	625
PUR (UL/CSA), robots/C-tracks	033	233	633	034	234	634	035 (126)	235	635 (732)
PUR (UL/CSA), welding spark	053	253	653	054	254	654	055	255	655
3 Cable Length									
1.5 m	0150								
3.0 m	0300								
5.0 m	0500								
7.5 m	0750								
10.0 m	1000								
Technical Data									
Operating voltage	max. 250 V AC/DC						max. 125 V AC/DC		
Protection	IP65, IP66K, IP67 inserted and tightened (EN 60529)								
Temperature range	-25...+85 °C, depending on cable quality								
Article No.									
The composition of your article number is explained on page 3.1.i	7 0 0 0			-			-		
	7 0 0 5			M12 Lite (plastic hexagonal screw) on request					
	1 Form			2 Cable Type			3 Cable Length		
Notes	Other versions on request. Differing cable lengths up to 2 m can be ordered in 0.2 m steps, from 2 m on in 0.5 m steps.								

M12 ROUND PLUG CONNECTORS

With open ended wires

Female
straight



Approvals:  

* only for products with UL/CSA approved cable

M12 Round Plug Connectors

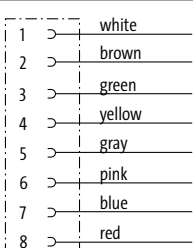
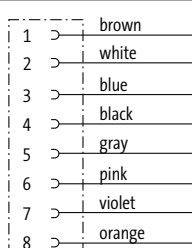
1 Form	17041	17041
Type	8-pole	8-pole
Circuit diagram		

Contact layout

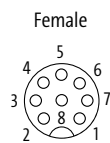

2 Cable Type	Jacket Color	Jacket Color
Wire diameter 0.25 mm ²	gray black yellow	gray black
PVC (UL/CSA)	207 607	208 608
PUR (UL/CSA), robots/Ctracks	292 722 114	295

3 Cable Length	
1.5 m	0150
3.0 m	0300
5.0 m	0500
7.5 m	0750
10.0 m	1000

Technical Data

Operating voltage	max. 30 V AC/DC
Protection	IP65, IP66K, IP67 inserted and tightened (EN 60529)
Temperature range	-25...+85 °C, depending on cable quality

Article No.

The composition of your article number is explained on page 3.1.i

7 0 0 0

7 0 0 5

M12 Lite (plastic hexagonal screw) on request

1 Form **2** Cable Type **3** Cable Length

Notes

Other versions on request. Differing cable lengths up to 2 m can be ordered in 0.2 m steps, from 2 m on in 0.5 m steps.

M12 ROUND PLUG CONNECTORS

With open ended wires

Female
straight

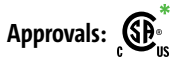

* only for products with UL/CSA approved cable

1 Form		19041	
Type	12-pole		
Circuit diagram			
Contact layout	<p>Female</p>		
2 Cable Type		Jacket Color	
Wire diameter 0.14 mm ²		gray	black
PVC (UL/CSA)		209	609
PUR (UL/CSA), robots/C-tracks			705
Wire diameter 0.25 mm ²			
PUR (UL/CSA), robots/C-tracks		301	
PUR (UL/CSA), welding spark		302	
3 Cable Length			
1.5 m	0150		
3.0 m	0300		
5.0 m	0500		
7.5 m	0750		
10.0 m	1000		
Technical Data			
Operating voltage	max. 30 V AC/DC		
Protection	IP65, IP66K, IP67 inserted and tightened (EN 60529)		
Temperature range	-25...+85 °C, depending on cable quality		
Article No.			
The composition of your article number is explained on page 3.1.i	<u>7</u> <u>0</u> <u>0</u> <u>0</u> - <u>1</u> <u>9</u> <u>0</u> <u>4</u> <u>1</u> - _ _ _		
	<u>7</u> <u>0</u> <u>0</u> <u>5</u> M12 Lite (plastic hexagonal screw) on request		
	1 Form	2 Cable Type	3 Cable Length
Notes			
Other versions on request. Differing cable lengths up to 2 m can be ordered in 0.2 m steps, from 2 m on in 0.5 m steps.			

M12 ROUND PLUG CONNECTORS

With open ended wires

Female
90°



Approvals:

* only for products with UL/CSA approved cable

1 Form	12321	12341	12361						
Type	3-pole	4-pole	5-pole						
Circuit diagram			<p>(* for cable type 126, 732, 219, 619)</p>						
Contact layout									
2 Cable Type	Jacket Color								
Wire diameter 0.34 mm ²	yellow	gray	black	yellow	gray	black	yellow	gray	black
PVC (UL/CSA)	013	213	613	014	214	614	015	215 (219)	615 (619)
PUR/PVC (UL/CSA)	023	223	623	024	224	624	025	225	625
PUR (UL/CSA), robots/C-tracks	033	233	633	034	234	634	035 (126)	235	635 (732)
PUR (UL/CSA), welding spark	053	253	653	054	254	654	055	255	655
3 Cable Length									
1.5 m	0150								
3.0 m	0300								
5.0 m	0500								
7.5 m	0750								
10.0 m	1000								
Technical Data									
Operating voltage	max. 250 V AC/DC						max. 125 V AC/DC		
Protection	IP65, IP66K, IP67 inserted and tightened (EN 60529)								
Temperature range	-25...+85 °C, depending on cable quality								
Article No.									
The composition of your article number is explained on page 3.1.i	7 0 0 0 - - - - - - - - - -								
	7 0 0 5 M12 Lite (plastic hexagonal screw) on request								
	1 Form			2 Cable Type			3 Cable Length		
Notes	Other versions on request. Differing cable lengths up to 2 m can be ordered in 0.2 m steps, from 2 m on in 0.5 m steps.								

M12 Round Plug Connectors

M12 ROUND PLUG CONNECTORS

With open ended wires

Female

90°



* only for products with UL/CSA approved cable

1 Form	170 61	170 61				
	Type	8-pole				
Circuit diagram						
	Contact layout	<p>Female</p>				
2 Cable Type	Jacket Color	Jacket Color				
	Wire diameter 0.25 mm ²	gray	black	yellow	gray	black
	PVC (UL/CSA)	207	607		208	608
	PUR (UL/CSA), robots/Ctracks	292	722	114	295	
3 Cable Length	1.5 m	0150				
	3.0 m	0300				
	5.0 m	0500				
	7.5 m	0750				
	10.0 m	1000				
Technical Data						
Operating voltage	max. 30 V AC/DC					
Protection	IP65, IP66K, IP67 inserted and tightened (EN 60529)					
Temperature range	-25...+85 °C, depending on cable quality					
Article No.						
The composition of your article number is explained on page 3.1.i	<p>7 0 0 0 - - - - -</p>					
	<p>7 0 0 5 M12 Lite (plastic hexagonal screw) on request</p>					
	1 Form	2 Cable Type	3 Cable Length			
Notes						
Other versions on request. Differing cable lengths up to 2 m can be ordered in 0.2 m steps, from 2 m on in 0.5 m steps.						

M12 ROUND PLUG CONNECTORS

With open ended wires

Female
90°

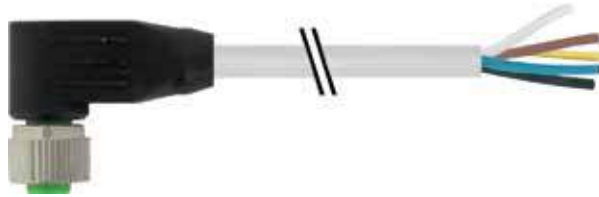

Approvals: 

* only for products with UL/CSA approved cable

1 Form 19061

Type 12-pole

Circuit diagram	
1	brown
2	blue
3	white
4	green
5	pink
6	yellow
7	black
8	gray
9	red
10	violet
11	gray/pink
12	red/blue

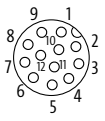
Contact layout	Female
	

2 Cable Type Jacket Color

Wire diameter 0.14 mm ²	gray	black
PVC (UL/CSA)	209	609
PUR (UL/CSA), robots/C-tracks		705
Wire diameter 0.25 mm ²		
PUR (UL/CSA), robots/C-tracks	301	
PUR (UL/CSA), welding spark	302	

3 Cable Length

1.5 m	0150
3.0 m	0300
5.0 m	0500
7.5 m	0750
10.0 m	1000

Technical Data

Operating voltage	max. 30 V AC/DC
Protection	IP65, IP66K, IP67 inserted and tightened (EN 60529)
Temperature range	-25...+85 °C, depending on cable quality

Article No.

The composition of your article number is explained on page 3.1.i	<u>7</u> <u>0</u> <u>0</u> <u>0</u> - <u>1</u> <u>9</u> <u>0</u> <u>6</u> <u>1</u> - _ _ _ _
	<u>7</u> <u>0</u> <u>0</u> <u>5</u> M12 Lite (plastic hexagonal screw) on request

1 Form **2** Cable Type **3** Cable Length

Notes Other versions on request. Differing cable lengths up to 2 m can be ordered in 0.2 m steps, from 2 m on in 0.5 m steps.

M12 ROUND PLUG CONNECTORS

With open ended wires

Female
straight, with LED



Female
90° with LED



* only for products with UL/CSA approved cable

1 Form		12261			12381		
Type		3-pole with 2 × LED (PNP) (NPN) on request			3-pole with 2 × LED (PNP) (NPN) on request		
Circuit diagram							
Contact layout		Female 					
2 Cable Type		Jacket Color			Jacket Color		
Wire diameter 0.34 mm ²		yellow	gray	black	yellow	gray	black
PVC (UL/CSA)		013	213	613	013	213	613
PUR/PVC (UL/CSA)		023	223	623	023	223	623
PUR (UL/CSA), robots/C-tracks		033	233	633	033	233	633
PUR (UL/CSA), welding spark		053	253	653	053	253	653
3 Cable Length							
1.5 m		0150					
3.0 m		0300					
5.0 m		0500					
7.5 m		0750					
10.0 m		1000					
Technical Data							
Operating voltage		24 V DC ±25%					
Protection		IP65, IP66K, IP67 inserted and tightened (EN 60529)					
Temperature range		-25...+85 °C, depending on cable quality					
Article No.							
The composition of your article number is explained on page 3.1.i		7 0 0 0			-		
		7 0 0 5			M12 Lite (plastic hexagonal screw) on request		
		1 Form		2 Cable Type		3 Cable Length	
Notes		Other versions on request. Differing cable lengths up to 2 m can be ordered in 0.2 m steps, from 2 m on in 0.5 m steps.					

M12 ROUND PLUG CONNECTORS

With open ended wires

Female
straight, with LED





Female
90° with LED

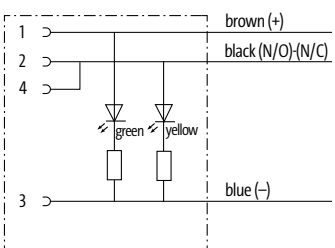

Approvals:  

* only for products with UL/CSA approved cable

1 Form	12281	12401				
Type	4-pole with 2 × LED (PNP) (NPN) on request	4-pole with 2 × LED (PNP) (NPN) on request				
Circuit diagram						
Contact layout	<p>Female</p> 					
2 Cable Type	Jacket Color			Jacket Color		
Wire diameter 0.34 mm ²	yellow	gray	black	yellow	gray	black
PVC (UL/CSA)	013	213	613	013	213	613
PUR/PVC (UL/CSA)	023	223	623	023	223	623
PUR (UL/CSA), robots/C-tracks	033	233	633	033	233	633
PUR (UL/CSA), welding spark	053	253	653	053	253	653
3 Cable Length						
1.5 m	0150					
3.0 m	0300					
5.0 m	0500					
7.5 m	0750					
10.0 m	1000					
Technical Data						
Operating voltage	24 V DC ±25%					
Protection	IP65, IP66K, IP67 inserted and tightened (EN 60529)					
Temperature range	-25...+85 °C, depending on cable quality					
Article No.						
The composition of your article number is explained on page 3.1.i	7 0 0 0			7 0 0 5		
	M12 Lite (plastic hexagonal screw) on request					
	1	Form	2	Cable Type	3	Cable Length
Notes	Other versions on request. Differing cable lengths up to 2 m can be ordered in 0.2 m steps, from 2 m on in 0.5 m steps.					

M12 ROUND PLUG CONNECTORS

With open ended wires

Female
straight, with LED



Female
90° with LED



* only for products with UL/CSA approved cable

1 Form		12231	12421			
Type		4-pole with 3 × LED (PNP) (NPN) on request	4-pole with 3 × LED (PNP) (NPN) on request			
Circuit diagram						
Contact layout	<p>Female</p>					
2 Cable Type	Jacket Color	Jacket Color				
Wire diameter 0.34 mm ²	yellow	gray	black	yellow	gray	black
PVC (UL/CSA)	014	214	614	014	214	614
PUR/PVC (UL/CSA)	024	224	624	024	224	624
PUR (UL/CSA), robots/C-tracks	034	234	634	034	234	634
PUR (UL/CSA), welding spark	054	254	654	054	254	654
3 Cable Length						
1.5 m	0150					
3.0 m	0300					
5.0 m	0500					
7.5 m	0750					
10.0 m	1000					
Technical Data						
Operating voltage	24 V DC ±25%					
Protection	IP65, IP66K, IP67 inserted and tightened (EN 60529)					
Temperature range	-25...+85 °C, depending on cable quality					
Article No.						
The composition of your article number is explained on page 3.1.i	7 0 0 0 - - - - -					
	7 0 0 5 M12 Lite (plastic hexagonal screw) on request					
	1 Form		2 Cable Type		3 Cable Length	
Notes	Other versions on request. Differing cable lengths up to 2 m can be ordered in 0.2 m steps, from 2 m on in 0.5 m steps.					

M12 ROUND PLUG CONNECTORS

With open ended wires

Female
straight, with LED





Female
90° with LED

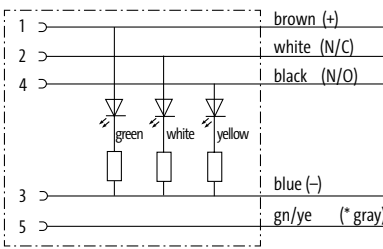

Approvals: 

* only for products with UL/CSA approved cable

1 Form	122 51	124 41
Approvals		cULus *
Type	5-pole with 3 × LED (PNP) (NPN) on request	5-pole with 3 × LED (PNP) (NPN) on request
Circuit diagram	 <p>(* for cable type 126, 732, 219, 619)</p>	
Contact layout	<p>Female</p> 	
2 Cable Type	Jacket Color	Jacket Color
Wire diameter 0.34 mm ²	yellow gray black	yellow gray black
PVC (UL/CSA)	015 215 (219) 615 (619)	015 215 (219) 615 (619)
PUR/PVC (UL/CSA)	025 225 625	025 225 625
PUR (UL/CSA), robots/C-tracks	035 (126) 235 635 (732)	035 (126) 235 635 (732)
PUR (UL/CSA), welding spark	055 255 655	055 255 655
3 Cable Length		
1.5 m	0150	
3.0 m	0300	
5.0 m	0500	
7.5 m	0750	
10.0 m	1000	
Technical Data		
Operating voltage	24 V DC ±25%	
Protection	IP65, IP66K, IP67 inserted and tightened (EN 60529)	
Temperature range	-25...+85 °C, depending on cable quality	
Article No.		
The composition of your article number is explained on page 3.1.i	7 0 0 0 - - - - - - - - - -	
	7 0 0 5 M12 Lite (plastic hexagonal screw) on request	
	1 Form	2 Cable Type
		3 Cable Length
Notes	Other versions on request. Differing cable lengths up to 2 m can be ordered in 0.2 m steps, from 2 m on in 0.5 m steps.	

M12 Round Plug Connectors

M12 ROUND PLUG CONNECTORS

With open ended wires

Male

straight



* only for products with UL/CSA approved cable

1 Form	13061	13081	13101
Type	3-pole, shielded	4-pole, shielded	5-pole, shielded
Circuit diagram			<p>(* for cable type 203, 603, 243, 643)</p>
Contact layout			
2 Cable Type	Jacket Color	Jacket Color	Jacket Color
Wire diameter 0.34 mm ²	gray black	gray black	gray black
PVC (UL/CSA)	200 600	201 601	202 (203) 602 (603)
PUR (UL/CSA), robots/Ctracks	240 640	241 641	242 (243) 642 (643)
3 Cable Length			
1.5 m	0150		
3.0 m	0300		
5.0 m	0500		
7.5 m	0750		
10.0 m	1000		
Technical Data			
Operating voltage	max. 60 V AC/DC		
Protection	IP65, IP66K, IP67 inserted and tightened (EN 60529)		
Temperature range	-25...+85 °C, depending on cable quality		
Article No.			
The composition of your article number is explained on page 3.1.i	<div style="display: flex; justify-content: space-around; align-items: center;"> 7 0 0 0 - - </div>		
	1 Form	2 Cable Type	3 Cable Length
Notes	Other versions on request. Differing cable lengths up to 2 m can be ordered in 0.2 m steps, from 2 m on in 0.5 m steps.		

M12 Round Plug Connectors

M12 ROUND PLUG CONNECTORS

With open ended wires

Male
straight



Approvals:  

* only for products with UL/CSA approved cable

M12 Round Plug Connectors

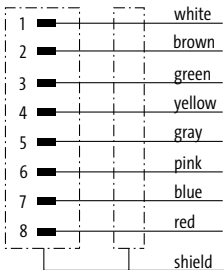
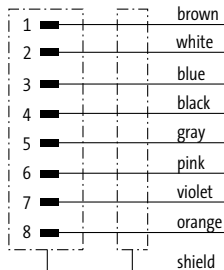
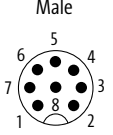
1 Form	17081	17081
Type	8-pole, shielded	8-pole, shielded
Circuit diagram		
Contact layout	<p>Male</p> 	

2 Cable Type	Jacket Color	Jacket Color
Wire diameter 0.25 mm ²	gray	black
PVC (UL/CSA)	204	205
PUR (UL/CSA), robots/C/tracks	291	717
		gray
		black
		294
		715

3 Cable Length	
1.5 m	0150
3.0 m	0300
5.0 m	0500
7.5 m	0750
10.0 m	1000

Technical Data	
Operating voltage	max. 30 V AC/DC
Protection	IP65, IP66K, IP67 inserted and tightened (EN 60529)
Temperature range	-25...+85 °C, depending on cable quality

Article No.

The composition of your article number is explained on page 3.1.i

7 0 0 0 - - - - -

1 Form **2** Cable Type **3** Cable Length

Notes

Other versions on request. Differing cable lengths up to 2 m can be ordered in 0.2 m steps, from 2 m on in 0.5 m steps.

M12 ROUND PLUG CONNECTORS

With open ended wires

Male

straight



Approvals: 

* only for products with UL/CSA approved cable

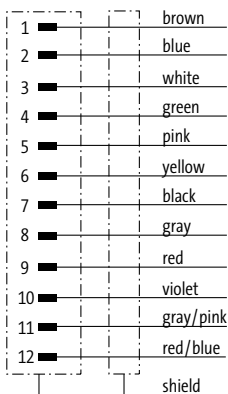
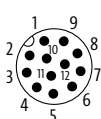
1 Form	19301	
Type	12-pole, shielded	
Circuit diagram		
Contact layout	<p>Male</p> 	
2 Cable Type	Jacket Color	
Wire diameter 0.14 mm ²	black	
PVC (UL/CSA)	703	
PUR (UL/CSA), robots/Ctracks	706	
3 Cable Length		
1.5 m	0150	
3.0 m	0300	
5.0 m	0500	
7.5 m	0750	
10.0 m	1000	
Technical Data		
Operating voltage	max. 30 V AC/DC	
Protection	IP65, IP66K, IP67 inserted and tightened (EN 60529)	
Temperature range	-25...+85 °C, depending on cable quality	
Article No.		
The composition of your article number is explained on page 3.1.i	<p>7 0 0 0 - 1 9 3 0 1 - - - -</p>	
	1 Form	2 Cable Type
		3 Cable Length
Notes	Other versions on request. Differing cable lengths up to 2 m can be ordered in 0.2 m steps, from 2 m on in 0.5 m steps.	

M12 ROUND PLUG CONNECTORS

With open ended wires

Male
90°



Approvals:  

* only for products with UL/CSA approved cable

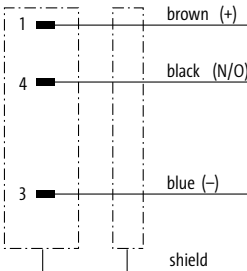
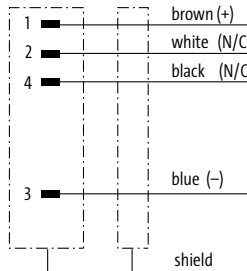
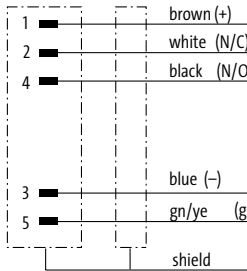
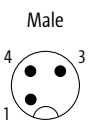
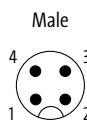
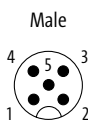
1 Form	13121	13141	13161	
Type	3-pole, shielded	4-pole, shielded	5-pole, shielded	
Circuit diagram			 <p>(* for cable type 203, 603, 243, 643)</p>	
Contact layout				
2 Cable Type	Jacket Color		Jacket Color	
	Wire diameter 0.34 mm ²	gray black	gray black	gray black
	PVC (UL/CSA)	200 600	201 601	202 (203) 602 (603)
PUR (UL/CSA), robots/C/tracks	240 640	241 641	242 (243) 642 (643)	
3 Cable Length	1.5 m	0150		
	3.0 m	0300		
	5.0 m	0500		
	7.5 m	0750		
	10.0 m	1000		
Technical Data				
Operating voltage	max. 60 V AC/DC			
Protection	IP65, IP66K, IP67 inserted and tightened (EN 60529)			
Temperature range	-25...+85 °C, depending on cable quality			
Article No.				
The composition of your article number is explained on page 3.1.i	<div style="display: flex; justify-content: space-around; align-items: center;"> 7 0 0 0 - - </div>			
	1	2	3	
	Form	Cable Type	Cable Length	
Notes				
Other versions on request. Differing cable lengths up to 2 m can be ordered in 0.2 m steps, from 2 m on in 0.5 m steps.				

M12 ROUND PLUG CONNECTORS

With open ended wires

Male

90°



* only for products with UL/CSA approved cable

1 Form		17101	17101
Type		8-pole, shielded	8-pole, shielded
Circuit diagram			
Contact layout		<p>Male</p>	
2 Cable Type		Jacket Color	Jacket Color
Wire diameter 0.25 mm ²		gray black	gray black
PVC (UL/CSA)		204	205
PUR (UL/CSA), robots/Ctracks		291 717	294 715
3 Cable Length			
1.5 m		0150	
3.0 m		0300	
5.0 m		0500	
7.5 m		0750	
10.0 m		1000	
Technical Data			
Operating voltage		max. 30 V AC/DC	
Protection		IP65, IP66K, IP67 inserted and tightened (EN 60529)	
Temperature range		-25...+85 °C, depending on cable quality	
Article No.			
The composition of your article number is explained on page 3.1.i		7 0 0 0 - - - - -	- - - - -
		1 Form	2 Cable Type 3 Cable Length
Notes			
		Other versions on request. Differing cable lengths up to 2 m can be ordered in 0.2 m steps, from 2 m on in 0.5 m steps.	

M12 Round Plug Connectors

M12 ROUND PLUG CONNECTORS

With open ended wires

Male
90°



Approvals: 

* only for products with UL/CSA approved cable

1 Form

19321

Type **12-pole, shielded**

Circuit diagram

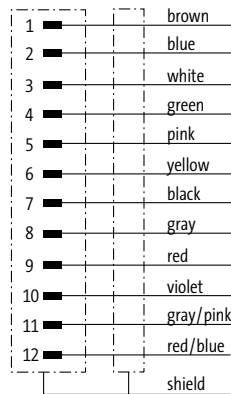

Contact layout

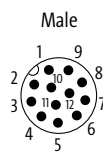

2 Cable Type

Jacket Color

Wire diameter 0.14 mm²

black

PVC (UL/CSA)

703

PUR (UL/CSA), robots/Ctracks

706

3 Cable Length

1.5 m	0150
3.0 m	0300
5.0 m	0500
7.5 m	0750
10.0 m	1000

Technical Data

Operating voltage	max. 30 V AC/DC
Protection	IP65, IP66K, IP67 inserted and tightened (EN 60529)
Temperature range	-25...+85 °C, depending on cable quality

Article No.

The composition of your article number is explained on page 3.1.i

7 0 0 0

-

1 9 3 2 1

-

1 Form

2 Cable Type

3 Cable Length

Notes

Other versions on request. Differing cable lengths up to 2 m can be ordered in 0.2 m steps, from 2 m on in 0.5 m steps.

M12 ROUND PLUG CONNECTORS

With open ended wires

 Female
straight

* only for products with UL/CSA approved cable

1 Form	13181	13201	13221
Type	3-pole, shielded	4-pole, shielded	5-pole, shielded
Circuit diagram			<p>(* for cable type 203, 603, 243, 643)</p>
Contact layout			
2 Cable Type	Jacket Color	Jacket Color	Jacket Color
Wire diameter 0.34 mm ²	gray black	gray black	gray black
PVC (UL/CSA)	200 600	201 601	202 (203) 602 (603)
PUR (UL/CSA), robots/Ctracks	240 640	241 641	242 (243) 642 (643)
3 Cable Length			
1.5 m	0150		
3.0 m	0300		
5.0 m	0500		
7.5 m	0750		
10.0 m	1000		
Technical Data			
Operating voltage	max. 60 V AC/DC		
Protection	IP65, IP66K, IP67 inserted and tightened (EN 60529)		
Temperature range	-25...+85 °C, depending on cable quality		
Article No.			
The composition of your article number is explained on page 3.1.i	<div style="display: flex; justify-content: space-between; align-items: center;"> 7 0 0 0 - _____ - _____ - _____ </div>		
	1 Form	2 Cable Type	3 Cable Length
Notes	Other versions on request. Differing cable lengths up to 2 m can be ordered in 0.2 m steps, from 2 m on in 0.5 m steps.		

M12 ROUND PLUG CONNECTORS

With open ended wires

Female
straight



Approvals: 

* only for products with UL/CSA approved cable

M12 Round Plug Connectors

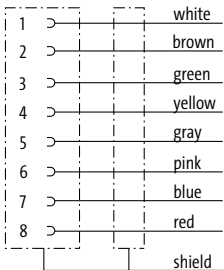
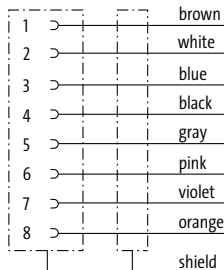
1 Form	17121	17121
Type	8-pole, shielded	8-pole, shielded
Circuit diagram		

Contact layout

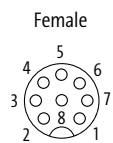

2 Cable Type	Jacket Color	Jacket Color
Wire diameter 0.25 mm ²	gray	black
PVC (UL/CSA)	204	205
PUR (UL/CSA), robots/Ctracks	291	717
		gray
		black
		294
		715

3 Cable Length	
1.5 m	0150
3.0 m	0300
5.0 m	0500
7.5 m	0750
10.0 m	1000

Technical Data

Operating voltage	max. 30 V AC/DC
Protection	IP65, IP66K, IP67 inserted and tightened (EN 60529)
Temperature range	-25...+85 °C, depending on cable quality

Article No.

The composition of your article number is explained on page 3.1.i

7 0 0 0 - - - - -

1 Form

2 Cable Type

3 Cable Length

Notes

Other versions on request. Differing cable lengths up to 2 m can be ordered in 0.2 m steps, from 2 m on in 0.5 m steps.

M12 ROUND PLUG CONNECTORS

With open ended wires

Female

straight



Approvals: 

* only for products with UL/CSA approved cable

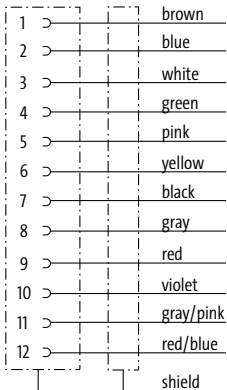
1 Form	19341	
Type	12-pole, shielded	
Circuit diagram		
Contact layout	<p>Female</p> 	
2 Cable Type	Jacket Color	
Wire diameter 0.14 mm ²	black	
PVC (UL/CSA)	703	
PUR (UL/CSA), robots/Ctracks	706	
3 Cable Length		
1.5 m	0150	
3.0 m	0300	
5.0 m	0500	
7.5 m	0750	
10.0 m	1000	
Technical Data		
Operating voltage	max. 30 V AC/DC	
Protection	IP67 inserted and tightened (EN 60529)	
Temperature range	-25...+85 °C, depending on cable quality	
Article No.		
The composition of your article number is explained on page 3.1.i	<p>7 0 0 0 - 1 9 3 4 1 - - - -</p>	
	1 Form	2 Cable Type
		3 Cable Length
Notes	Other versions on request. Differing cable lengths up to 2 m can be ordered in 0.2 m steps, from 2 m on in 0.5 m steps.	

M12 ROUND PLUG CONNECTORS

With open ended wires

Female
90°



Approvals:

* only for products with UL/CSA approved cable

1 Form	13241	13261	13281
Type	3-pole, shielded	4-pole, shielded	5-pole, shielded
Circuit diagram			<p>(* for cable type 203, 603, 243, 643)</p>
Contact layout	<p>Female</p>	<p>Female</p>	<p>Female</p>
2 Cable Type	Jacket Color	Jacket Color	Jacket Color
Wire diameter 0.34 mm ²	gray black	gray black	gray black
PVC (UL/CSA)	200 600	201 601	202 (203) 602 (603)
PUR (UL/CSA), robots/C/tracks	240 640	241 641	242 (243) 642 (643)
3 Cable Length			
1.5 m	0150		
3.0 m	0300		
5.0 m	0500		
7.5 m	0750		
10.0 m	1000		
Technical Data			
Operating voltage	max. 60 V AC/DC		
Protection	IP65, IP66K, IP67 inserted and tightened (EN 60529)		
Temperature range	-25...+85 °C, depending on cable quality		
Article No.			
The composition of your article number is explained on page 3.1.i	<div style="display: flex; justify-content: space-around; align-items: center;"> 7 0 0 0 - - </div>		
	1 Form	2 Cable Type	3 Cable Length
Notes	Other versions on request. Differing cable lengths up to 2 m can be ordered in 0.2 m steps, from 2 m on in 0.5 m steps.		

M12 ROUND PLUG CONNECTORS

With open ended wires

Female

90°



* only for products with UL/CSA approved cable

1 Form		17141	17141
Type	8-pole, shielded	8-pole, shielded	8-pole, shielded
Circuit diagram			
Contact layout	<p>Female</p>		
2 Cable Type		Jacket Color	
Wire diameter 0.25 mm ²		gray	black
PVC (UL/CSA)		204	205
PUR (UL/CSA), robots/Ctracks		291	717
		gray	black
		294	715
3 Cable Length			
1.5 m	0150		
3.0 m	0300		
5.0 m	0500		
7.5 m	0750		
10.0 m	1000		
Technical Data			
Operating voltage	max. 30 V AC/DC		
Protection	IP65, IP66K, IP67 inserted and tightened (EN 60529)		
Temperature range	-25...+85 °C, depending on cable quality		
Article No.			
The composition of your article number is explained on page 3.1.i	<p>7 0 0 0 - - - - -</p>		
	1 Form	2 Cable Type	3 Cable Length
Notes			
		Other versions on request. Differing cable lengths up to 2 m can be ordered in 0.2 m steps, from 2 m on in 0.5 m steps.	

M12 ROUND PLUG CONNECTORS

With open ended wires

Female
90°



Approvals: 

* only for products with UL/CSA approved cable

1 Form

19361

Type **12-pole, shielded**

Circuit diagram

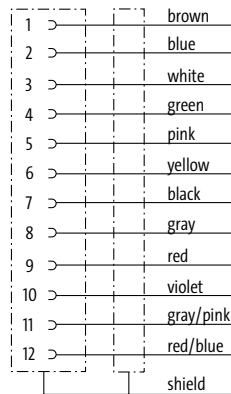

Contact layout

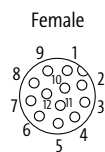

2 Cable Type

Jacket Color

Wire diameter 0.14 mm²

black

PVC (UL/CSA)

703

PUR (UL/CSA), robots/Ctracks

706

3 Cable Length

1.5 m	0150
3.0 m	0300
5.0 m	0500
7.5 m	0750
10.0 m	1000

Technical Data

Operating voltage	max. 30 V AC/DC
Protection	IP65, IP66K, IP67 inserted and tightened (EN 60529)
Temperature range	-25...+85 °C, depending on cable quality

Article No.

The composition of your article number is explained on page 3.1.i

7 0 0 0

-

1 9 3 6 1

-

1 Form

2 Cable Type

3 Cable Length

Notes

Other versions on request. Differing cable lengths up to 2 m can be ordered in 0.2 m steps, from 2 m on in 0.5 m steps.

M12 ROUND PLUG CONNECTORS

Connection cables

– M12 - M12

Male
straight

Female
straight



* only for products with UL/CSA approved cable

1 Form	40001	40021	40041						
Type	3-pole	4-pole	5-pole						
Circuit diagram			<p>(* for cable type 126, 732, 219, 619)</p>						
Contact layout									
2 Cable Type	Jacket Color								
Wire diameter 0.34 mm ²	yellow	gray	black	yellow	gray	black	yellow	gray	black
PVC (UL/CSA)	013	213	613	014	214	614	015	215 (219)	615 (619)
PUR/PVC (UL/CSA)	023	223	623	024	224	624	025	225	625
PUR (UL/CSA), robots/C-tracks	033	233	633	034	234	634	035 (126)	235	635 (732)
PUR (UL/CSA), welding spark	053	253	653	054	254	654	055	255	655
3 Cable Length									
0.3 m	0030								
0.6 m	0060								
1.0 m	0100								
1.5 m	0150								
2.0 m	0200								
Technical Data									
Operating voltage	max. 250 V AC/DC						max. 125 V AC/DC		
Protection	IP65, IP66K, IP67 inserted and tightened (EN 60529)								
Temperature range	-25...+85 °C, depending on cable quality								
Article No.									
The composition of your article number is explained on page 3.1.i	7 0 0 0 - - - - -								
	7 0 0 5 M12 Lite (plastic hexagonal screw) on request								
	1 Form			2 Cable Type			3 Cable Length		
Notes	Other versions on request. Differing cable lengths up to 2 m can be ordered in 0.2 m steps, from 2 m on in 0.5 m steps.								

M12 ROUND PLUG CONNECTORS

Connection cables

– M12 - M12

Male

straight

Female

straight



Approvals:  

* only for products with UL/CSA approved cable

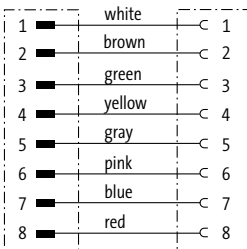
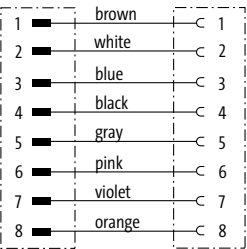
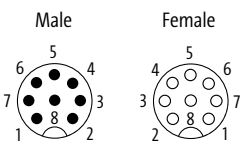
1 Form		48001			48001				
Type	8-pole				8-pole				
Circuit diagram									
Contact layout									
2 Cable Type		Jacket Color			Jacket Color				
Wire diameter 0.25 mm ²	gray	black	yellow		gray	black			
PVC (UL/CSA)	207	607			208	608			
PUR (UL/CSA), robots/Ctracks	292	722	114		295				
3 Cable Length									
0.3 m	0030								
0.6 m	0060								
1.0 m	0100								
1.5 m	0150								
2.0 m	0200								
Technical Data									
Operating voltage	max. 30 V AC/DC								
Protection	IP65, IP66K, IP67 inserted and tightened (EN 60529)								
Temperature range	-25...+85 °C, depending on cable quality								
Article No.									
The composition of your article number is explained on page 3.1.i	7 0 0 0			-			-		
	7 0 0 5			M12 Lite (plastic hexagonal screw) on request					
	1 Form		2 Cable Type		3 Cable Length				
Notes		Other versions on request. Differing cable lengths up to 2 m can be ordered in 0.2 m steps, from 2 m on in 0.5 m steps.							

M12 ROUND PLUG CONNECTORS

Connection cables

– M12 - M12

Male

straight

Female

straight



Approvals: 

* only for products with UL/CSA approved cable

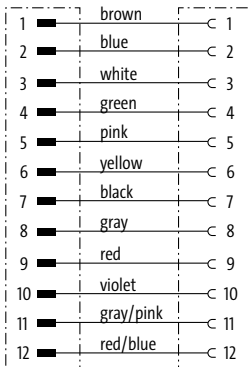
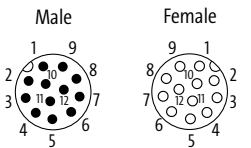
1 Form	53001	
Type	12-pole	
Circuit diagram		
Contact layout		
2 Cable Type	Jacket Color	
Wire diameter 0.14 mm ²	gray	black
PVC (UL/CSA)	209	609
PUR (UL/CSA), robots/C-tracks		705
Wire diameter 0.25 mm ²		
PUR (UL/CSA), robots/C-tracks	301	
PUR (UL/CSA), welding spark	302	
3 Cable Length		
0.3 m	0030	
0.6 m	0060	
1.0 m	0100	
1.5 m	0150	
2.0 m	0200	
Technical Data		
Operating voltage	max. 30 V AC/DC	
Protection	IP65, IP66K, IP67 inserted and tightened (EN 60529)	
Temperature range	-25...+85 °C, depending on cable quality	
Article No.		
The composition of your article number is explained on page 3.1.i	<p>7 0 0 0 - 5 3 0 0 1 - - - -</p> <p>7 0 0 5 M12 Lite (plastic hexagonal screw) on request</p>	
	1 Form	2 Cable Type
		3 Cable Length
Notes	Other versions on request. Differing cable lengths up to 2 m can be ordered in 0.2 m steps, from 2 m on in 0.5 m steps.	

M12 ROUND PLUG CONNECTORS

Connection cables

– M12 - M12

Male

straight

Female

90°



Approvals:

* only for products with UL/CSA approved cable

1 Form	40101	40121	40141						
Type	3-pole	4-pole	5-pole						
Circuit diagram			<p>(* for cable type 126, 732, 219, 619)</p>						
Contact layout									
2 Cable Type	Jacket Color								
Wire diameter 0.34 mm ²	yellow	gray	black	yellow	gray	black	yellow	gray	black
PVC (UL/CSA)	013	213	613	014	214	614	015	215 (219)	615 (619)
PUR/PVC (UL/CSA)	023	223	623	024	224	624	025	225	625
PUR (UL/CSA), robots/C-tracks	033	233	633	034	234	634	035 (126)	235	635 (732)
PUR (UL/CSA), welding spark	053	253	653	054	254	654	055	255	655
3 Cable Length									
0.3 m	0030								
0.6 m	0060								
1.0 m	0100								
1.5 m	0150								
2.0 m	0200								
Technical Data									
Operating voltage	max. 250 V AC/DC						max. 125 V AC/DC		
Protection	IP65, IP66K, IP67 inserted and tightened (EN 60529)								
Temperature range	-25...+85 °C, depending on cable quality								
Article No.									
The composition of your article number is explained on page 3.1.i	7 0 0 0 - - - - -								
	7 0 0 5 M12 Lite (plastic hexagonal screw) on request								
	1 Form			2 Cable Type			3 Cable Length		
Notes	Other versions on request. Differing cable lengths up to 2 m can be ordered in 0.2 m steps, from 2 m on in 0.5 m steps.								

M12 ROUND PLUG CONNECTORS

Connection cables

– M12 - M12

Male

straight

Female

90° with LED



* only for products with UL/CSA approved cable

1 Form	40321	40341	40361
Type	3-pole with 2 × LED (PNP) (NPN) on request	4-pole with 3 × LED (PNP) (NPN) on request	5-pole with 3 × LED (PNP) (NPN) on request
Circuit diagram			<p>(* for cable type 126, 732, 219, 619)</p>
Contact layout			
2 Cable Type	Jacket Color	Jacket Color	Jacket Color
Wire diameter 0.34 mm ²	yellow gray black	yellow gray black	yellow gray black
PVC (UL/CSA)	013 213 613	014 214 614	015 215 (219) 615 (619)
PUR/PVC (UL/CSA)	023 223 623	024 224 624	025 225 625
PUR (UL/CSA), robots/C-tracks	033 233 633	034 234 634	035 (126) 235 635 (732)
PUR (UL/CSA), welding spark	053 253 653	054 254 654	055 255 655
3 Cable Length			
0.3 m	0030		
0.6 m	0060		
1.0 m	0100		
1.5 m	0150		
2.0 m	0200		
Technical Data			
Operating voltage	24 V DC ±25%		
Protection	IP65, IP66K, IP67 inserted and tightened (EN 60529)		
Temperature range	-25...+85 °C, depending on cable quality		
Article No.			
The composition of your article number is explained on page 3.1.i	<p>7 0 0 0 - - - - - - - - - -</p> <p>7 0 0 5 M12 Lite (plastic hexagonal screw) on request</p>		
	1 Form	2 Cable Type	3 Cable Length
Notes	Other versions on request. Differing cable lengths up to 2 m can be ordered in 0.2 m steps, from 2 m on in 0.5 m steps.		

M12 ROUND PLUG CONNECTORS

Connection cables

– M12 - M12

Male

straight

Female

90° with LED



Approvals:  

* only for products with UL/CSA approved cable

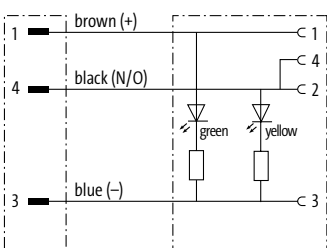
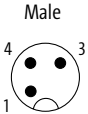
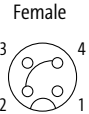
1 Form	40381		
	Type	3-pole with 2 × LED (PNP) (NPN) on request	
Circuit diagram			
Contact layout			
2 Cable Type	Wire diameter 0.34 mm²	Jacket Color	
	PVC (UL/CSA)	yellow	gray black
	PUR/PVC (UL/CSA)	013	213 613
	PUR (UL/CSA), robots/C-tracks	023	223 623
	PUR (UL/CSA), welding spark	033	233 633
		053	253 653
3 Cable Length	0.3 m	0030	
	0.6 m	0060	
	1.0 m	0100	
	1.5 m	0150	
	2.0 m	0200	
Technical Data	Operating voltage	24 V DC ±25%	
	Protection	IP65, IP66K, IP67 inserted and tightened (EN 60529)	
	Temperature range	-25...+85 °C, depending on cable quality	
Article No.	<p>The composition of your article number is explained on page 3.1.i</p> <p>7 0 0 0 - 4 0 3 8 1 - _ _ _ _</p> <p>7 0 0 5 M12 Lite (plastic hexagonal screw) on request</p>		
	1 Form	2 Cable Type	3 Cable Length
Notes	Other versions on request. Differing cable lengths up to 2 m can be ordered in 0.2 m steps, from 2 m on in 0.5 m steps.		

M12 ROUND PLUG CONNECTORS

Connection cables

– M12 - M12

Y connector

Male straight

Females

straight

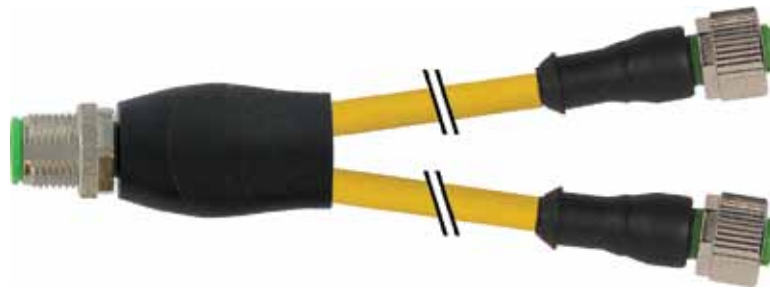

* only for products with UL/CSA approved cable

1 Form	40701	40721				
Type	4-/3-pole	4-pole				
Circuit diagram						
Contact layout						
2 Cable Type	Jacket Color	Jacket Color				
Wire diameter 0.34 mm ²	yellow	gray	black	yellow	gray	black
PVC (UL/CSA)	013	213	613	013	213	613
PUR/PVC (UL/CSA)	023	223	623	023	223	623
PUR (UL/CSA), robots/C-tracks	033	233	633	033	233	633
PUR (UL/CSA), welding spark	053	253	653	053	253	653
3 Cable Length						
0.3 m	0030					
0.6 m	0060					
1.0 m	0100					
1.5 m	0150					
2.0 m	0200					
Technical Data						
Operating voltage	max. 250 V AC/DC					
Protection	IP65, IP66K, IP67 inserted and tightened (EN 60529)					
Temperature range	-25...+85 °C, depending on cable quality					
Article No.						
The composition of your article number is explained on page 3.1.i	<p>7 0 0 0 - - - - -</p> <p>7 0 0 5 M12 Lite (plastic hexagonal screw) on request</p>					
	1 Form	2 Cable Type	3 Cable Length			
Notes	Other versions on request. Differing cable lengths up to 2 m can be ordered in 0.2 m steps, from 2 m on in 0.5 m steps.					

M12 ROUND PLUG CONNECTORS

Connection cables

– M12 - M12

Y connector

Male straight

Females

90°



* only for products with UL/CSA approved cable

M12 Round Plug Connectors	1 Form	40741			40761		
	Type	4-/3-pole			4-pole		
	Circuit diagram						
	Contact layout						
2 Cable Type	Cable Type	Jacket Color			Jacket Color		
	Wire diameter 0.34 mm ²	yellow	gray	black	yellow	gray	black
	PVC (UL/CSA)	013	213	613	013	213	613
	PUR/PVC (UL/CSA)	023	223	623	023	223	623
	PUR (UL/CSA), robots/C-tracks	033	233	633	033	233	633
	PUR (UL/CSA), welding spark	053	253	653	053	253	653
3 Cable Length	Cable Length						
	0.3 m	0030					
	0.6 m	0060					
	1.0 m	0100					
	1.5 m	0150					
	2.0 m	0200					
Technical Data	Technical Data						
	Operating voltage	max. 250 V AC/DC					
	Protection	IP65, IP66K, IP67 inserted and tightened (EN 60529)					
	Temperature range	-25...+85 °C, depending on cable quality					
Article No.	Article No.						
	The composition of your article number is explained on page 3.1.i	7 0 0 0			7 0 0 5		
					M12 Lite (plastic hexagonal screw) on request		
		1 Form		2 Cable Type		3 Cable Length	
Notes	Notes						
		Other versions on request. Differing cable lengths up to 2 m can be ordered in 0.2 m steps, from 2 m on in 0.5 m steps.					

M12 ROUND PLUG CONNECTORS

Connection cables

– M12 - M12

Y connector

Male straight

Females

90° with LED



* only for products with UL/CSA approved cable

1 Form	40781	40801
Type	4-/3-pole LED (yellow/green)	4-pole LED (yellow/green)
Circuit diagram		
Contact layout		
2 Cable Type	Jacket Color	Jacket Color
Wire diameter 0.34 mm ²	yellow gray black	yellow gray black
PVC (UL/CSA)	013 213 613	013 213 613
PUR/PVC (UL/CSA)	023 223 623	023 223 623
PUR (UL/CSA), robots/C-tracks	033 233 633	033 233 633
PUR (UL/CSA), welding spark	053 253 653	053 253 653
3 Cable Length		
0.3 m	0030	
0.6 m	0060	
1.0 m	0100	
1.5 m	0150	
2.0 m	0200	
Technical Data		
Operating voltage	24 V DC ±25%	
Protection	IP65, IP66K, IP67 inserted and tightened (EN 60529)	
Temperature range	-25...+85 °C, depending on cable quality	
Article No.		
The composition of your article number is explained on page 3.1.i	<p>7 0 0 0 - - - - -</p> <p>7 0 0 5 M12 Lite (plastic hexagonal screw) on request</p>	
	1 Form	2 Cable Type
		3 Cable Length
Notes	Other versions on request. Differing cable lengths up to 2 m can be ordered in 0.2 m steps, from 2 m on in 0.5 m steps.	

M12 ROUND PLUG CONNECTORS

Connection cables

– M12 - M12

Male

straight

Female

straight



Approvals:  

* only for products with UL/CSA approved cable

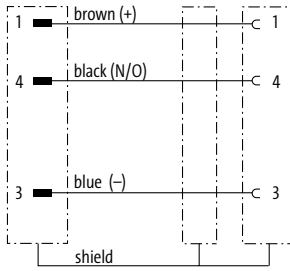
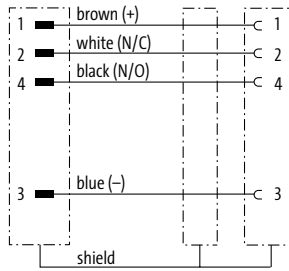
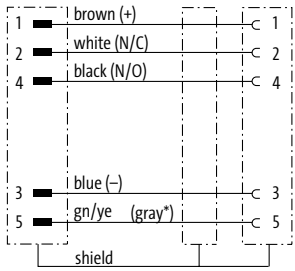
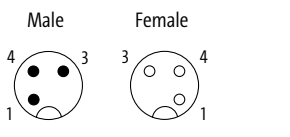
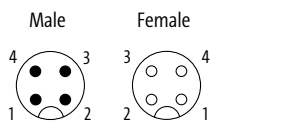
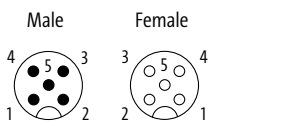
1 Form	40481	40501	40521
Type	3-pole, shielded	4-pole, shielded	5-pole, shielded
Circuit diagram			 <p>(* for cable type 203, 603, 243, 643)</p>
Contact layout			
Cable Type	Jacket Color	Jacket Color	Jacket Color
Wire diameter 0.34 mm ²	gray black	gray black	gray black
PVC (UL/CSA)	200 600	201 601	202 (203) 602 (603)
PUR (UL/CSA), robots/Ctracks	240 640	241 641	242 (243) 642 (643)
Cable Length			
0.3 m	0030		
0.6 m	0060		
1.0 m	0100		
1.5 m	0150		
2.0 m	0200		
Technical Data			
Operating voltage	max. 60 V AC/DC		
Protection	IP65 and IP67 when plugged and screwed down (EN 60529)		
Temperature range	-25...+85 °C, depending on cable quality		
Article No.			
The composition of your article number is explained on page 3.1.i	<div style="display: flex; justify-content: space-around; align-items: center;"> 7 0 0 0 - - </div>		
	1 Form	2 Cable Type	3 Cable Length
Notes	Other versions on request. Differing cable lengths up to 2 m can be ordered in 0.2 m steps, from 2 m on in 0.5 m steps.		

M12 ROUND PLUG CONNECTORS

Connection cables

– M12 - M12

Male

straight

Female

straight



* only for products with UL/CSA approved cable

1 Form		48041	48041
Type		8-pole, shielded	8-pole, shielded
Circuit diagram			
Contact layout			
2 Cable Type		Jacket Color	
Wire diameter 0.25 mm ²		gray	black
PVC (UL/CSA)		204	205
PUR (UL/CSA), robots/Ctracks		291	717
		gray	black
		294	715
3 Cable Length			
0.3 m		0030	
0.6 m		0060	
1.0 m		0100	
1.5 m		0150	
2.0 m		0200	
Technical Data			
Operating voltage		max. 30 V AC/DC	
Protection		IP65, IP66K, IP67 inserted and tightened (EN 60529)	
Temperature range		-25...+85 °C, depending on cable quality	
Article No.			
The composition of your article number is explained on page 3.1.i		7 0 0 0	- - - - -
		1 Form	2 Cable Type
			3 Cable Length
Notes			
		Other versions on request. Differing cable lengths up to 2 m can be ordered in 0.2 m steps, from 2 m on in 0.5 m steps.	

M12 ROUND PLUG CONNECTORS

Connection cables

– M12 - M12

Male

straight

Female

straight



Approvals: 

* only for products with UL/CSA approved cable

1 Form

53301

Type

12-pole, shielded

Circuit diagram

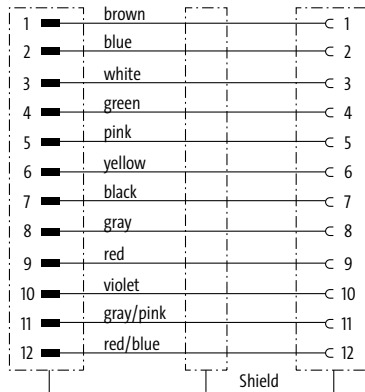

Contact layout

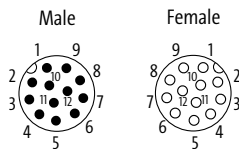

2 Cable Type

Jacket Color

Wire diameter 0.14 mm²

PVC (UL/CSA)

PUR (UL/CSA), robots/Ctracks

black

703

706

3 Cable Length

0.3 m

0030

0.6 m

0060

1.0 m

0100

1.5 m

0150

2.0 m

0200

Technical Data

Operating voltage

max. 30 V AC/DC

Protection

IP67 inserted and tightened (EN 60529)

Temperature range

-25...+85 °C, depending on cable quality

Article No.

The composition of your article number is explained on page 3.1.i

7 0 0 0

–

5 3 3 0 1

–

— — —

— — — —

1 Form

2 Cable Type

3 Cable Length

Notes

Other versions on request. Differing cable lengths up to 2 m can be ordered in 0.2 m steps, from 2 m on in 0.5 m steps.

M12 ROUND PLUG CONNECTORS

Field-wireable

– IDC terminals

Male
straight



Female
straight



1 Form	12461 me×	12481 me×	12581 me×	12601 me×
Type	3-pole	4-pole	3-pole	4-pole
Circuit diagram				
Connection cross section	0.25...0.5 mm ²			
Contact layout				
Technical Data				
Operating voltage	max. 32 V AC/DC			
Operating current per contact	max. 4 A			
Connection cross section	0.25...0.5 mm ² (conductor diameter min. 0.1 mm)			
Sealing range (cable Ø)	4...5.1 mm			
Wire isolation	PVC, PP, TPE			
Outer wire Ø	1.2...1.6 mm			
Locking of ports	Screw thread M12 × 1 mm (recommended torque 0.6 Nm) self-securing			
Protection	IP67 inserted and tightened (EN 60529)			
Reconnection (cable)	10			
Temperature range	-25...+85 °C			
Article No.				
The composition of your article number is explained on page 3.1.i	7 0 0 0 - - - - - 0 0 0 0 0 0 0 0			
	7 0 0 5 M12 Lite (plastic hexagonal screw) on request			
1 Form				
Notes				
Other versions on request.				

M12 ROUND PLUG CONNECTORS

Field-wireable
– IDC terminals

Male
straight, compact



Female
straight, compact



1 Form **12491** **me** **12611** **me**

Approvals **cURus**
Type **4-pole** **4-pole**

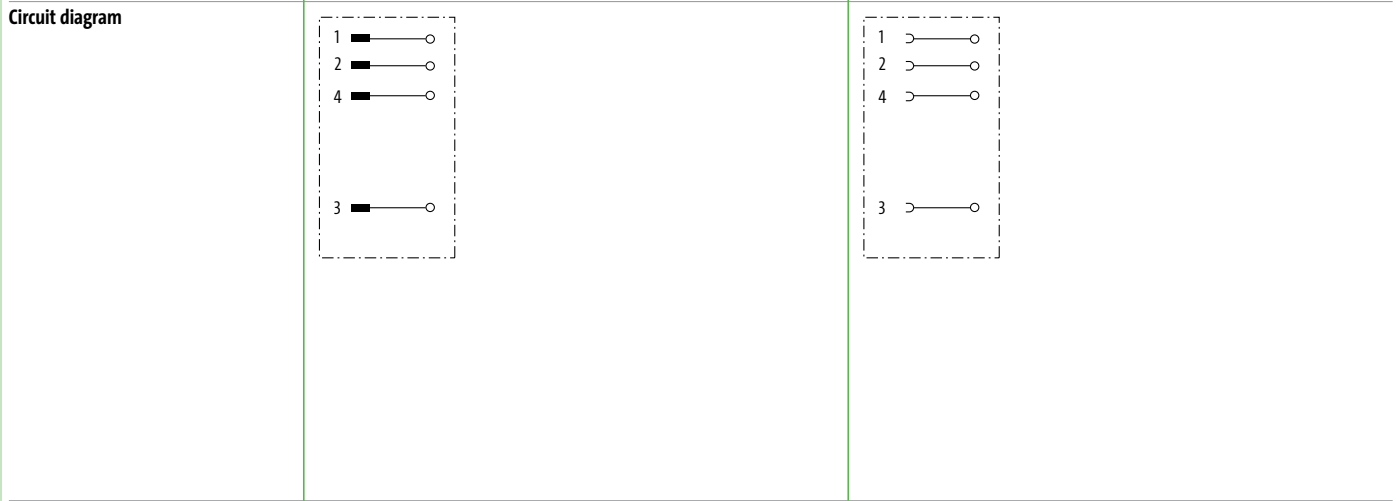

Connection cross section **0.14...0.34 mm²**



Technical Data

Operating voltage	max. 32 V AC/DC
Operating current per contact	max. 4 A
Connection cross section	0.14...0.34 mm ² (conductor diameter min. 0.1 mm)
Sealing range (cable Ø)	2.9...5.1 mm
Wire isolation	PVC, PP, TPE
Outer wire Ø	1.0...1.6 mm
Locking of ports	Screw thread M12 × 1 mm (recommended torque 0.6 Nm) self-securing
Protection	IP67 inserted and tightened (EN 60529)
Reconnection (cable)	10
Temperature range	-25...+85 °C

Article No.

The composition of your article number is explained on page 3.1.i

7 0 0 0 - - - - - - - 0 0 0 0 0 0 0

1 Form

Notes

Other versions on request.

M12 ROUND PLUG CONNECTORS

Field-wireable

– IDC terminals

Male

90°



Female

90°



1 Form	12541 me×	12561 me×	12661 me×	12681 me×
Approvals		cURus		
Type	3-pole	4-pole	3-pole	4-pole
Circuit diagram				
Connection cross section	0.25...0.5 mm ²			
Contact layout	<p>Male</p>	<p>Male</p>	<p>Female</p>	<p>Female</p>
Technical Data				
Operating voltage	max. 32 V AC/DC			
Operating current per contact	max. 4 A			
Connection cross section	0.25...0.5 mm ² (conductor diameter min. 0.1 mm)			
Sealing range (cable Ø)	4...5.1 mm			
Wire isolation	PVC, PP, TPE			
Outer wire Ø	1.2...1.6 mm			
Locking of ports	Screw thread M12 × 1 mm (recommended torque 0.6 Nm) self-securing			
Protection	IP67 inserted and tightened (EN 60529)			
Reconnection (cable)	10			
Temperature range	-25...+85 °C			
Article No.				
The composition of your article number is explained on page 3.1.i	<p><u>7</u> <u>0</u> <u>0</u> <u>0</u> - - - - - - - - - - - - - - - - <u>0</u> <u>0</u> <u>0</u> <u>0</u> <u>0</u> <u>0</u></p> <p><u>7</u> <u>0</u> <u>0</u> <u>5</u> M12 Lite (plastic hexagonal screw) on request</p>			
	1 Form			
Notes	Other versions on request.			

M12 ROUND PLUG CONNECTORS

Field-wireable
– IDC terminals

Female
90° with LED



1	Form	12671	me	12691	me
----------	-------------	--------------	-----------	--------------	-----------

Type	3-pole with 2 × LED (PNP)	4-pole with 3 × LED (PNP)
Circuit diagram		

Connection cross section	0.25...0.5 mm ²	
Contact layout	<p>Female</p>	<p>Female</p>

Technical Data	
Operating voltage	24 V DC ±25%
Operating current per contact	max. 4 A
Connection cross section	0.25...0.5 mm ² (conductor diameter min. 0.1 mm)
Sealing range (cable Ø)	4...5.1 mm
Wire isolation	PVC, PP, TPE
Outer wire Ø	1.2...1.6 mm
Locking of ports	Screw thread M12 × 1 mm (recommended torque 0.6 Nm) self-securing
Protection	IP67 inserted and tightened (EN 60529)
Reconnection (cable)	10
Temperature range	-25...+85 °C

Article No.																																										
The composition of your article number is explained on page 3.1.i	<table style="margin: auto; border-collapse: collapse;"> <tr> <td style="border: 1px solid black; padding: 2px 5px;">7</td> <td style="border: 1px solid black; padding: 2px 5px;">0</td> <td style="border: 1px solid black; padding: 2px 5px;">0</td> <td style="border: 1px solid black; padding: 2px 5px;">0</td> <td style="padding: 0 10px;">-</td> <td style="padding: 0 10px;">-</td> <td style="padding: 0 10px;">-</td> <td style="padding: 0 10px;">-</td> <td style="padding: 0 10px;">-</td> <td style="padding: 0 10px;">-</td> <td style="padding: 0 10px;">-</td> <td style="padding: 0 10px;">-</td> <td style="border: 1px solid black; padding: 2px 5px;">0</td> <td style="border: 1px solid black; padding: 2px 5px;">0</td> <td style="border: 1px solid black; padding: 2px 5px;">0</td> <td style="padding: 0 10px;">-</td> <td style="border: 1px solid black; padding: 2px 5px;">0</td> <td style="border: 1px solid black; padding: 2px 5px;">0</td> <td style="border: 1px solid black; padding: 2px 5px;">0</td> <td style="border: 1px solid black; padding: 2px 5px;">0</td> </tr> <tr> <td colspan="10"></td> <td style="text-align: center; padding: 5px;">7 0 0 5</td> <td colspan="10"></td> </tr> </table> <p style="text-align: center; margin-top: 5px;">M12 Lite (plastic hexagonal screw) on request</p>	7	0	0	0	-	-	-	-	-	-	-	-	0	0	0	-	0	0	0	0											7 0 0 5										
7	0	0	0	-	-	-	-	-	-	-	-	0	0	0	-	0	0	0	0																							
										7 0 0 5																																

1 Form

Notes	Other versions on request.
--------------	----------------------------

M12 ROUND PLUG CONNECTORS

Field-wireable
– IDC terminals

Male
straight



1 Form	12501 me	12521 me	12515 me
Type	3-pole	4-pole	4-pole
Circuit diagram			
Connection cross section	0.5...1.0 mm ²		
Contact layout	Male 	Male 	Male
Technical Data			
Operating voltage	max. 32 V AC/DC		
Operating current per contact	max. 4 A		
Connection cross section	0.5...1.0 mm ² (conductor diameter min. 0.1 mm)		
Sealing range (cable Ø)	5.5...8 mm		
Wire isolation	PVC, PP, TPE		
Outer wire Ø	1.6...2.0 mm		
Locking of ports	Screw thread M12 × 1 mm (recommended torque 0.6 Nm) self-securing		
Protection	IP67 inserted and tightened (EN 60529)		
Reconnection (cable)	10		
Temperature range	-25...+85 °C		
Article No.			
The composition of your article number is explained on page 3.1.i	<div style="display: flex; justify-content: space-between; align-items: center;"> <u>7</u> <u>0</u> <u>0</u> <u>0</u> - _____ - <u>0</u> <u>0</u> <u>0</u> <u>0</u> <u>0</u> <u>0</u> <u>0</u> </div> <div style="display: flex; justify-content: space-between; align-items: center; margin-top: 5px;"> <u>7</u> <u>0</u> <u>0</u> <u>5</u> M12 Lite (plastic hexagonal screw) on request </div>		
	1 Form		
Notes	Other versions on request.		

M12 ROUND PLUG CONNECTORS

Field-wireable
– IDC terminals

Female
straight



1 Form 12621 **me** 12641 **me**

Type	3-pole	4-pole
Circuit diagram		

Connection cross section	0.5...1.0 mm ²	
Contact layout	<p>Female</p>	<p>Female</p>

Technical Data

Operating voltage	max. 32 V AC/DC
Operating current per contact	max. 4 A
Connection cross section	0.5...1.0 mm ² (conductor diameter min. 0.1 mm)
Sealing range (cable Ø)	5.5...8 mm
Wire isolation	PVC, PP, TPE
Outer wire Ø	1.6...2.0 mm
Locking of ports	Screw thread M12 × 1 mm (recommended torque 0.6 Nm) self-securing
Protection	IP67 inserted and tightened (EN 60529)
Reconnection (cable)	10
Temperature range	-25...+85 °C

Article No.

The composition of your article number is explained on page 3.1.i	<u>7</u> <u>0</u> <u>0</u> <u>0</u> - - - - - - - - - - <u>0</u> <u>0</u> <u>0</u> <u>0</u>
	<u>7</u> <u>0</u> <u>0</u> <u>5</u> M12 Lite (plastic hexagonal screw) on request

1 Form

Notes	Other versions on request.
-------	----------------------------

M12 ROUND PLUG CONNECTORS

Field-wireable

– Screw terminals

Male

straight



Female

straight



Approvals:

1 Form	12701 me×	12721 me×	12901 me×	12921 me×
Type	4-pole	5-pole	4-pole	5-pole
Circuit diagram				
Sealing range (cable Ø)	4...6 mm			
Contact layout	Male 	Male 	Female 	Female
Technical Data				
Operating voltage	max. 250 V AC/DC	max. 60 V AC/DC	max. 250 V AC/DC	max. 60 V AC/DC
Operating current per contact	max. 4 A			
Connection cross section	max. 0.75 mm ²			
Sealing range (cable Ø)	4...6 mm			
Locking of ports	Screw thread M12 × 1 mm (recommended torque 0.6 Nm) self-securing			
Protection	IP67 inserted and tightened (EN 60529)			
Temperature range	-40...+85 °C			
Article No.				
The composition of your article number is explained on page 3.1.i	<u>7</u> <u>0</u> <u>0</u> <u>0</u>	-	-	<u>0</u> <u>0</u> <u>0</u> <u>0</u>
	1 Form			
Notes	Other versions on request.			

M12 ROUND PLUG CONNECTORS

Field-wireable
– Screw terminals

Male
straight

Female
straight



Approvals:

M12 Round Plug Connectors

1 Form	12741 me ^x	12761 me ^x	12941 me ^x	12961 me ^x
Type	4-pole	5-pole	4-pole	5-pole
Circuit diagram				
Sealing range (cable Ø)	6...8 mm			
Contact layout	Male 	Male 	Female 	Female
Technical Data				
Operating voltage	max. 250 V AC/DC	max. 60 V AC/DC	max. 250 V AC/DC	max. 60 V AC/DC
Operating current per contact	max. 4 A			
Connection cross section	max. 0.75 mm ²			
Sealing range (cable Ø)	6...8 mm			
Locking of ports	Screw thread M12 × 1 mm (recommended torque 0.6 Nm) self-securing			
Protection	IP67 inserted and tightened (EN 60529)			
Temperature range	-40...+85 °C			
Article No.				
The composition of your article number is explained on page 3.1.i	<u>7</u> <u>0</u> <u>0</u> <u>0</u>	-	-	<u>0</u> <u>0</u> <u>0</u> <u>0</u>
	1 Form			
Notes	Other versions on request.			

M12 ROUND PLUG CONNECTORS

Field-wireable

– Screw terminals

Male
straight



Female
straight



Male
90°



Female
90°



Approvals: **ULus**

1 Form	17301 me×	17321 me×	17311 me×	17331 me×
Type	8-pole	8-pole	8-pole	8-pole
Circuit diagram				
Sealing range (cable Ø)	6...8 mm			
Contact layout	<p>Male</p>	<p>Female</p>	<p>Male</p>	<p>Female</p>
Technical Data				
Operating voltage	max. 30 V AC/DC			
Operating current per contact	max. 2 A			
Connection cross section	max. 0.5 mm ²			
Sealing range (cable Ø)	6...8 mm			
Locking of ports	Screw thread M12 × 1 mm (recommended torque 0.6 Nm) self-securing			
Protection	IP67 inserted and tightened (EN 60529)			
Temperature range	-40...+85 °C			
Article No.				
The composition of your article number is explained on page 3.1.i	<u>7</u> <u>0</u> <u>0</u> <u>0</u>	-	-	<u>0</u> <u>0</u> <u>0</u> <u>0</u>
	1 Form			
Notes	Other versions on request.			

M12 ROUND PLUG CONNECTORS

Field-wireable
– Screw terminals

Male
90°



Female
90°



Approvals:

M12 Round Plug Connectors

1 Form	12821 me*	12841 me*	12981 me*	13001 me*
Type	4-pole	5-pole	4-pole	5-pole
Circuit diagram				
Sealing range (cable Ø)	4...6 mm			
Contact layout				
Technical Data				
Operating voltage	max. 250 V AC/DC	max. 60 V AC/DC	max. 250 V AC/DC	max. 60 V AC/DC
Operating current per contact	max. 4 A			
Connection cross section	max. 0.75 mm ²			
Sealing range (cable Ø)	4...6 mm			
Locking of ports	Screw thread M12 × 1 mm (recommended torque 0.6 Nm) self-securing			
Protection	IP67 inserted and tightened (EN 60529)			
Temperature range	-40...+85 °C			
Article No.				
The composition of your article number is explained on page 3.1.i	<u>7</u> <u>0</u> <u>0</u> <u>0</u>	-	-	<u>0</u> <u>0</u> <u>0</u> <u>0</u>
		1 Form		
Notes	Other versions on request.			

M12 ROUND PLUG CONNECTORS

Field-wireable

– Screw terminals

Male

90°



Female

90°



Approvals:

M12 Round Plug Connectors

1 Form	12861 me×	12881 me×	13021 me×	13041 me×
Type	4-pole	5-pole	4-pole	5-pole
Circuit diagram				
Sealing range (cable Ø)	6...8 mm			
Contact layout	<p>Male</p>	<p>Male</p>	<p>Female</p>	<p>Female</p>
Technical Data				
Operating voltage	max. 250 V AC/DC	max. 60 V AC/DC	max. 250 V AC/DC	max. 60 V AC/DC
Operating current per contact	max. 4 A			
Connection cross section	max. 0.75 mm ²			
Sealing range (cable Ø)	6...8 mm			
Locking of ports	Screw thread M12 × 1 mm (recommended torque 0.6 Nm) self-securing			
Protection	IP67 inserted and tightened (EN 60529)			
Temperature range	-40...+85 °C			
Article No.				
The composition of your article number is explained on page 3.1.i	<u>7</u> <u>0</u> <u>0</u> <u>0</u>	-	-	<u>0</u> <u>0</u> <u>0</u> <u>0</u>
	1 Form			
Notes	Other versions on request.			

M12 ROUND PLUG CONNECTORS

Field-wireable
– Screw terminals

Male
straight

Female
straight

Male
90°

Female
90°



Approvals: UL US Listed

1 Form **12731 me** **12931 me** **12851 me** **13011 me**

Type 5-pole 5-pole 5-pole 5-pole

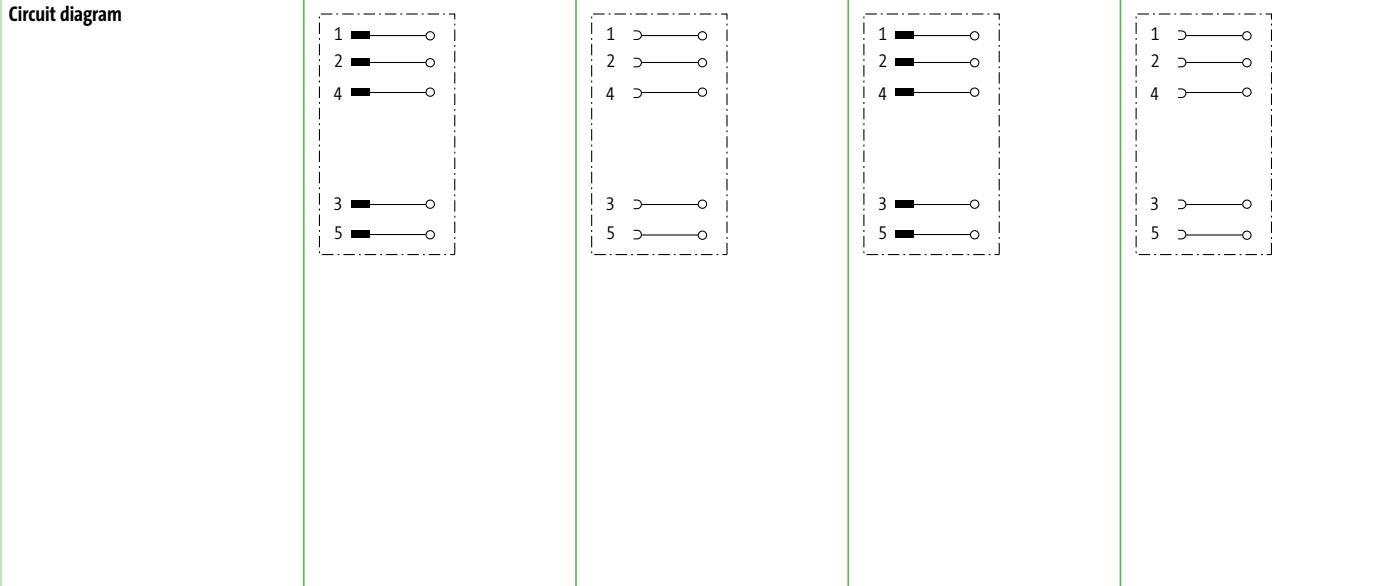

Sealing range (cable Ø) 2.5...8.0 mm

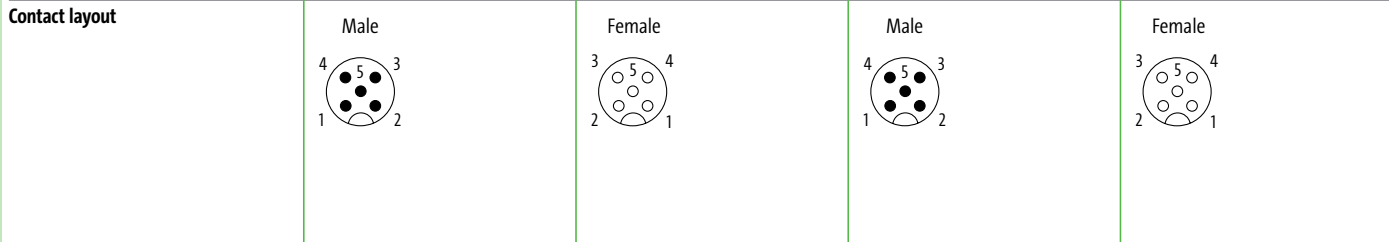

Technical Data

Operating voltage	max. 60 V AC/DC
Operating current per contact	max. 7.5 A (+40 °C; 1.5 mm ²)
Connection cross section	max. 1.5 mm ²
Sealing range (cable Ø)	2.5...8.0 mm
Locking of ports	Screw thread M12 × 1 mm (recommended torque 0.6 Nm)
Protection	IP67 inserted and tightened (EN 60529)
Temperature range	-30...+85 °C

Article No.

The composition of your article number is explained on page 3.1.i	<u>7</u> <u>0</u> <u>0</u> <u>0</u> - - - - - - - - - - <u>0</u> <u>0</u> <u>0</u>	<u>0</u> <u>0</u> <u>0</u> <u>0</u>
	1 Form	

Notes Other versions on request.

M12 Round Plug Connectors



M12 ROUND PLUG CONNECTORS

Field-wireable
– Screw terminals

Y connector
Male straight

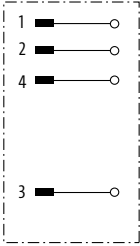
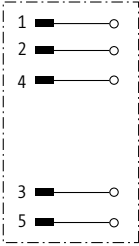

M12 Round Plug Connectors

1 Form	12781 me✖	12801 me✖
Type Circuit diagram	4-pole 	5-pole 
Sealing range (cable Ø) Contact layout	2.1...3/4...5 mm Male 	Male 
Technical Data		
Operating voltage	max. 250 V AC/DC	
Operating current per contact	max. 4 A	
Connection cross section	max. 0.75 mm ²	
Sealing range (cable Ø)	2.1...3/4...5 mm (2 cable entries)	
Protection	IP67 inserted and tightened (EN 60529)	
Temperature range	-40...+85 °C	
Article No.		
The composition of your article number is explained on page 3.1.i	<u>7 0 0 0</u> – <u> </u> – <u>0 0 0</u> <u>0 0 0 0</u>	
1 Form		
Notes Other versions on request.		

M12 ROUND PLUG CONNECTORS

Field-wireable
– Screw terminals

Male
straight



Female
straight



1 Form	13301 me*	13321 me*	13381 me*	13401 me*
Approvals		cURus		cURus
Type	5-pole, shielded	5-pole, shielded	5-pole, shielded	5-pole, shielded
Circuit diagram				
Sealing range (cable Ø)	4...6 mm	6...8 mm	4...6 mm	6...8 mm
Contact layout	<p>Male</p>		<p>Female</p>	
Technical Data				
Operating voltage	max. 60 V AC/DC			
Operating current per contact	max. 4 A			
Connection cross section	max. 0.75 mm ²			
Sealing range (cable Ø)	4...6 mm	6...8 mm	4...6 mm	6...8 mm
Protection	IP67 inserted and tightened (EN 60529)			
Housing	Brass, nickel plated			
Temperature range	-40...+85 °C			
Article No.				
The composition of your article number is explained on page 3.1.i	<u>7</u> <u>0</u> <u>0</u> <u>0</u>	-	-	<u>0</u> <u>0</u> <u>0</u> <u>0</u>
		1	Form	
Notes	Other versions on request.			

M12 ROUND PLUG CONNECTORS

Field-wireable

– Screw terminals

Male
straight

Female
straight

Male
90°

Female
90°

Approvals:

1 Form	17341 me \times	17361 me \times	17351 me \times	17371 me \times
Type	8-pole, shielded	8-pole, shielded	8-pole, shielded	8-pole, shielded
Circuit diagram				
Sealing range (cable \emptyset)	6...8 mm			
Contact layout	Male 	Female 	Male 	Female
Technical Data				
Operating voltage	max. 30 V AC/DC			
Operating current per contact	max. 2 A			
Connection cross section	max. 0.5 mm ²			
Sealing range (cable \emptyset)	6...8 mm			
Protection	IP67 inserted and tightened (EN 60529)			
Housing	Brass, nickel plated			
Temperature range	-40...+85 °C			
Article No.				
The composition of your article number is explained on page 3.1.i	7 0 0 0 - 0 0 0 0 0 0 0			
	1 Form			
Notes				
	Other versions on request.			

M12 ROUND PLUG CONNECTORS

Field-wireable
– Screw terminals

Male
90°





Female
90°



1 Form	13341 me*	13361 me*	13421 me*	13441 me*
Approvals				cURus
Type	5-pole, shielded	5-pole, shielded	5-pole, shielded	5-pole, shielded
Circuit diagram				
Sealing range (cable Ø)	4...6 mm	6...8 mm	4...6 mm	6...8 mm
Contact layout	<p>Male</p>		<p>Female</p>	
Technical Data				
Operating voltage	max. 60 V AC/DC			
Operating current per contact	max. 4 A			
Connection cross section	max. 0.75 mm ²			
Sealing range (cable Ø)	4...6 mm	6...8 mm	4...6 mm	6...8 mm
Protection	IP67 inserted and tightened (EN 60529)			
Housing	Brass, nickel plated			
Temperature range	-40...+85 °C			
Article No.				
The composition of your article number is explained on page 3.1.i	<u>7</u> <u>0</u> <u>0</u> <u>0</u>	-	-	<u>0</u> <u>0</u> <u>0</u> <u>0</u>
		1	Form	
Notes				
Other versions on request.				

M12 ROUND PLUG CONNECTORS

Labeling accessories			Art-No.
	Slip-on cable sleeve for ACS label plates (4 × 18 mm)	Cable diameter (4...6.5 mm)	7000-99004-0000000
	Snap-on cable sleeve for ACS label plates (4 × 18 mm)	Cable diameter (4.2...5.6 mm)	7000-99005-0000000
	for ACS label plates (4 × 18 mm)	Cable diameter (5...7 mm)	7000-99006-0000000
	ACS label plate for self marking (4 × 18 mm)		7000-99002-0000000
	Colored ring M8/M12 sandy yellow	for unshielded molding	7000-99301-V011002
	zinc yellow	for unshielded molding	7000-99301-V011018
	redorange	for unshielded molding	7000-99301-V012008
	red	for unshielded molding	7000-99301-V013020
	violet	for unshielded molding	7000-99301-V014003
	purple	for unshielded molding	7000-99301-V014006
	blue	for unshielded molding	7000-99301-V015005
	green	for unshielded molding	7000-99301-V016018
	gray	for unshielded molding	7000-99301-V017035
	white	for unshielded molding	7000-99301-V019003
black	for unshielded molding	7000-99301-V019004	
Mounting accessories			Art-No.
	Torque wrench set M12 (0.6 Nm, SW13)	M12 data connenctor molded (standard)	7000-99102-0000000
	Torque wrench M12 (0.6 Nm, SW13)	M12 data connenctor molded (standard)	7000-99109-0000000
	Torque wrench M12 (0.6 Nm, SW17)	M12 field-wireable (IDC terminal)	7000-99094-0000000
	Torque wrench M12 (0.6 Nm, SW18)	M12 field-wireable via (screw terminals)	7000-99103-0000000
	Hold clip M12 Plastic		7000-99045-0000000

M12 ROUND PLUG CONNECTORS

End fitting accessories			Art-No.
	Tube adapter snap-in for corrugated tube (size 13mm)	Cable diameter (4...7 mm)	7000-99081-000000
Connection accessories			Art-No.
	Universal holder modular	M8 M12	7000-99801-000000
	Universal holder modular	M12 Y-connector M12	7000-99811-000000
	Flange M12 male, pre-wired 0.2 m straight, A-coded, 4-pole		7000-13501-9710020
	straight, A-coded, 5-pole	DeviceNet, CANopen	7000-13521-9720020
	straight, A-coded, 8-pole		7000-17161-9730020
	Flange M12 female, pre-wired 0.2 m straight, A-coded, 4-pole		7000-13541-9710020
	straight, A-coded, 5-pole	DeviceNet, CANopen	7000-13561-9720020
	straight, A-coded, 8-pole		7000-17181-9730020

T-COUPLERS VERSATILE ADAPTERS

- Slimline saves space
- Minimizes wiring efforts
- Many different configurations

T-COUPLERS FOR PERFECT SYSTEM INSTALLATIONS

Increasingly, automation requires a large number of sensors and with each sensor comes more wiring.

By using T-couplers you reduce the number of cables required and you can combine inputs and outputs depending on the application. Thanks to the slim design, you can connect several M12 ports to our Cube module. The handy torque wrench makes installation easy even in tight spaces and guarantees IP67 seals.

The slimline T-couplers feature a new female screw connection which makes the connection even safer and easier.

T-couplers



M8 male
T-coupler
T-coupler (Nano)

M8 female
T-coupler
T-coupler (Nano)

Page 3.3.1



M12 male
T-coupler

M12 female
T-coupler

Page 3.3.2



M12 female
T-coupler
• Industrial Ethernet

M12 male/M12 female
T-coupler

Page 3.3.4



7/8" male
T-coupler

7/8" female
T-coupler

Page 3.3.5

T-COUPLERS M8, M12, 7/8"

M8 - M8

T-coupler

Male straight - female straight



T-coupler (Nano)

Male straight - female straight



1 Form	88611	88621	88602
Approvals	cULus	cULus	
Type	3-pole Parallel circuit	3-pole Series connection	3-/4-pole Distribution function (NO)
Circuit diagram			
Contact layout			
Technical Data			
Operating voltage	max. 50 V AC/60 V DC		max. 32 V AC/DC
Rated surge voltage	1.5 kV		0.8 kV
Operating current per contact	max. 4 A		max. 2 A
Locking of ports	Screw thread M8 x 1 mm (recommended torque 0.4 Nm) self-securing		Screw thread M8 x 1 mm, self-securing
Protection	IP67 inserted and tightened (EN 60529)		
Temperature range	-25...+85 °C		-30...+80 °C
Article No.			
The composition of your article number is explained on page 3.1.i	<div style="display: flex; justify-content: space-around; align-items: center;"> <u>7</u> <u>0</u> <u>0</u> <u>0</u> - _____ - <u>0</u> <u>0</u> <u>0</u> <u>0</u> <u>0</u> <u>0</u> <u>0</u> </div>		
	1 Form		
Notes	Other versions on request.		

T-COUPPLERS M8, M12, 7/8"

M12 - M12

T-coupler

Male straight - female straight



Approvals: UL US Listed

T-couplers M8, M12, 7/8"

1 Form	41121	41141	41161	41181
Type	5-pole	5-pole	4-pole	5-pole
Distribution function (NO)		Parallel circuit	Series connection	Distribution function (NO)
Circuit diagram	<p>1. Female M12 2. Female</p> <p>Male M12</p>	<p>1. Female M12 2. Female</p> <p>Male M12</p>	<p>1. Female M12 2. Female</p> <p>Male M12</p>	<p>1. Female M12 2. Female</p> <p>Male M12</p>

Contact layout

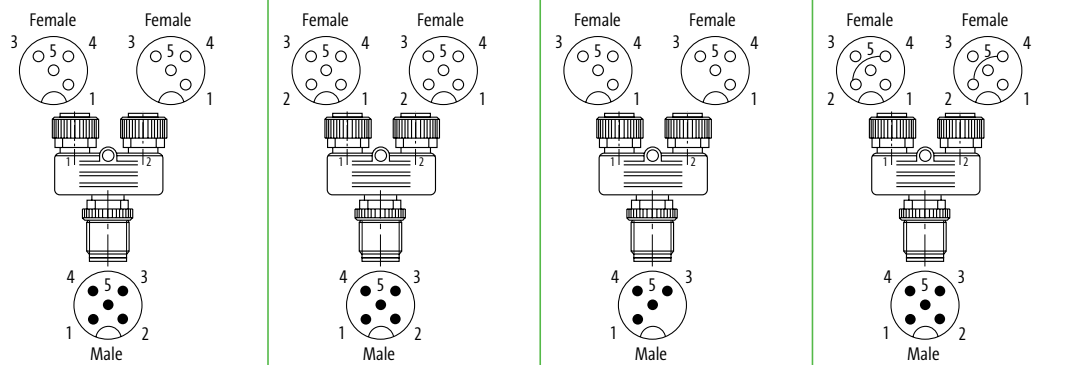

Technical Data

Operating voltage	max. 60 V AC/DC
Operating voltage (only UL listed)	30 V AC/DC
Rated surge voltage	1.5 kV
Operating current per contact	max. 4 A
Material group	IEC 60664-1, category I
Locking of ports	Screw thread M12 × 1 mm (recommended torque 0.6 Nm) self-securing
Protection	IP67 inserted and tightened (EN 60529)
Locking material	Zinc die casting, matte nickel plated
Temperature range	-25...+85 °C

Article No.

The composition of your article number is explained on page 3.1.i

7 0 0 0

- - - - -

0 0 0

0 0 0 0

1 Form

Notes

Other versions on request.

T-COUPLERS M8, M12, 7/8"

M12 - M12

T-coupler (Slim Line)

Male straight - female straight



T-coupler (Slim Line)

Male straight - female straight with LED



Approvals: UL Listed

1 Form	41131	41151	41191	41135
Type	5-pole	5-pole	5-pole	5-pole with 3 × LED (PNP)
Distribution function (NO)		Parallel circuit		
Circuit diagram	<p>1. Female M12 2. Female</p> <p>Male M12</p>	<p>1. Female M12 2. Female</p> <p>Male M12</p>	<p>1. Female M12 2. Female</p> <p>Male M12</p>	<p>1. Female M12 2. Female</p> <p>Male M12</p>
Contact layout				
Technical Data				
Operating voltage	max. 60 V AC/DC			24 V DC ±25%
Operating voltage (only UL listed)	30 V AC/DC			30 V DC
Rated surge voltage	1.5 kV			0.8 kV
Operating current per contact	max. 4 A			
Locking of ports	Screw thread M12 × 1 mm (recommended torque 0.6 Nm) self-securing			
Protection	IP67 inserted and tightened (EN 60529)			
Temperature range	-25...+85 °C			
Article No.				
The composition of your article number is explained on page 3.1.i	<u>7</u> <u>0</u> <u>0</u> <u>0</u>	-	<u>0</u> <u>0</u> <u>0</u>	<u>0</u> <u>0</u> <u>0</u> <u>0</u>
	1 Form			
Notes	Other versions on request.			

T-couplers M8, M12, 7/8"

T-COUPLERS M8, M12, 7/8"

Industrial Ethernet

– M12 - M12

T-coupler

Female straight - male/female straight



T-coupler

Female straight - female straight



1 Form

47301

4-/8-pole, shielded

Y-coded, D-coded

Distribution function (NO)

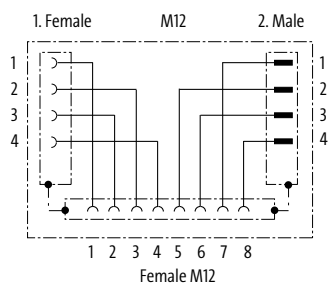

47311

4-/8-pole, shielded

Y-coded, D-coded

Distribution function (NO)

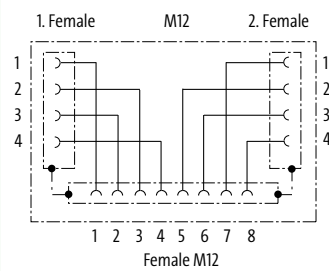

Circuit diagram

Contact layout

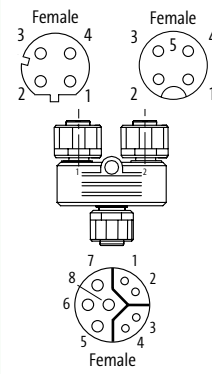
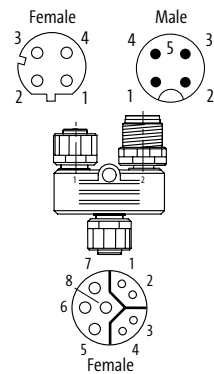

Technical Data

Operating voltage	max. 30 V DC
Rated surge voltage	0.8 kV
Operating current per contact	4 A (Power), 0.5 A (Data)
Material group	IEC 60664-1, category I
Transfer parameters	CAT5, Class D (ISO/IEC 11801:2002), (EN 50173-1)
Transfer rate	to 100 Mbit/s Full Duplex
Locking of ports	Screw thread M12 × 1 mm (recommended torque 0.6 Nm) self-securing
Protection	IP54 inserted and tightened (EN 60529)
Locking material	Zinc die casting, matte nickel plated
Temperature range	-25...+85 °C

Article No.

The composition of your article number is explained on page 3.1.i

7 0 0 0

-

0 0 0

0 0 0 0

1 Form

Notes

Other versions on request.

T-COUPLERS M8, M12, 7/8"

7/8" - 7/8"

T-coupler
Female straight - male/female straight



1 Form **50061**

Type **5-pole**

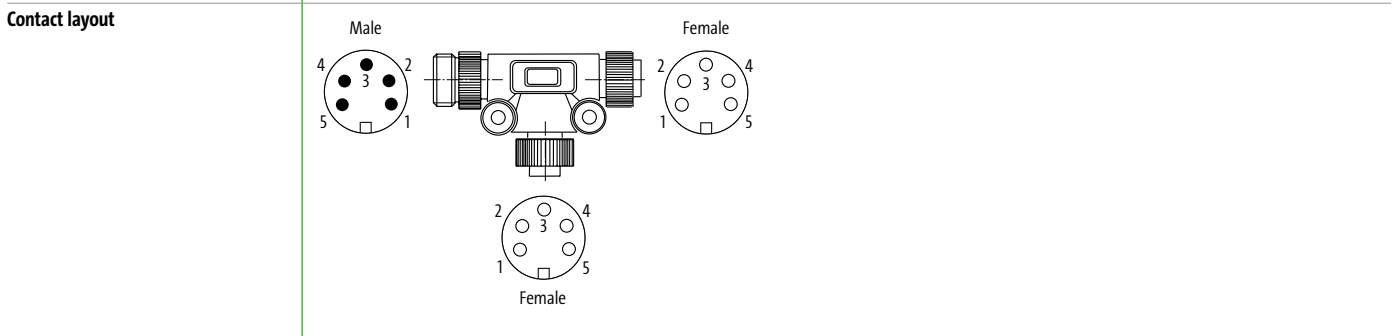
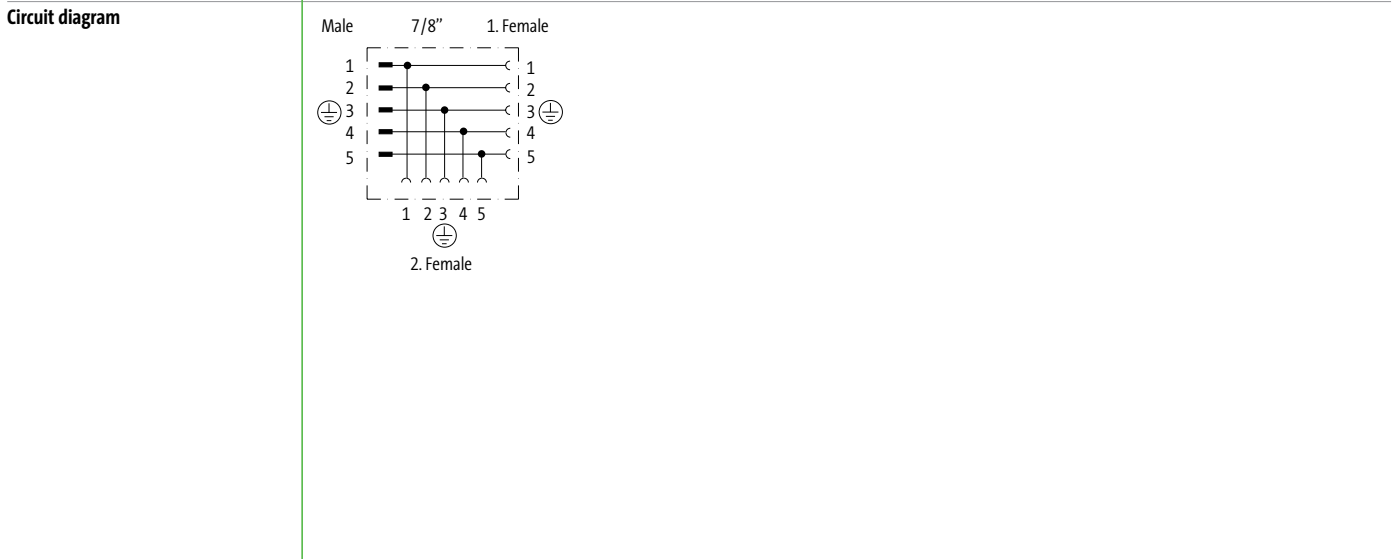

Technical Data

Operating voltage	max. 50 V AC/DC
Operating current per contact	max. 8 A
Protection	IP67 inserted and tightened (EN 60529)
Locking material	Zinc die casting
Temperature range	-20...+80 °C

Article No.

The composition of your article number is explained on page 3.1.i

7 0 0 0 - 5 0 0 6 1 - 0 0 0 0 0 0

1 Form

Notes
Other versions on request.

T-couplers M8, M12, 7/8"

T-COUPPLERS M8, M12, 7/8"

Mounting accessories			Art-No.
	Holding plate for T-couplers M12 (SlimLine)	with mounting set	7000-99062-000000
	Mounting clamp		7000-99063-000000

T-couplers M8, M12, 7/8"



FLANGE CONNECTORS READY FOR ANYTHING

- Molded PVC or PP wires
- Anti-twist protection ensures convenient assembly
- Front and rear mounting

COMPREHENSIVE RANGE TO CUSTOMER NEEDS

Murrelektronik has a wide range of M12 flange plug connectors and offers solutions for all kinds of applications. Encapsulated components guarantee a high level of short-circuit protection. In addition, the integrated anti-rotation protection makes installation very easy.

Don't see what you needed? Visit shop.murrelektronik.com for other styles including V4A Stainless Steel for Food & Beverage applications.

M8



- Male/female**
- 3-pole
 - 4-pole

Page 3.4.1

M12



- Male/female**
- 3-pole
 - 4-pole
 - 5-pole
 - 8-pole

Page 3.4.2



- Control Cabinet Entry System
Male/female (shielded)**
- 5-pole
 - 6-pole
 - 8-pole

Page 3.4.12

Power

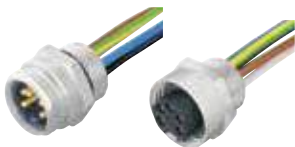

- 7/8"**
Male/female
- 5-pole

Page 3.4.4



- M12 Power
Male/female**
- 4-pole
 - 5-pole

Page 3.4.5



- MQ15 X-Power
Male/female**
- 4-pole
 - 6-pole

Page 3.4.8



- MQ15 X-Power
Male/female (shielded housing)**
- 4-pole
 - 6-pole

Page 3.4.10

FLANGE CONNECTORS

With multi-strand wire

– M8

Approvals:

Flange male

Front mounting

Flange female

Front mounting



1 Form	08552	08562	08571	08581
Type	3-pole	4-pole	3-pole	4-pole
Circuit diagram				
Contact layout	Male 	Male 	Female 	Female
2 Wires				
Wire diameter 0.25 mm ²	multi-colored	multi-colored	multi-colored	multi-colored
PP	970	969	970	969
PVC	910	911	910	911
Hexagonal nut M8 × 0.5	7000-08591-0000000			
3 Wires Length				
0.2 m	0020			
0.5 m	0050			
1.0 m	0100			
Technical Data				
Operating voltage	max. 50 V AC/60 V DC			
Protection	IP67 inserted and tightened (EN 60529)			
Temperature range	-25...+85 °C			
Article No.				
The composition of your article number is explained on page 3.1.i	<div style="display: flex; justify-content: space-around; align-items: center;"> 7 0 0 0 - - </div>			
	1 Form	2 Wires	3 Wires Length	
Notes	Other versions on request.			

Flange Connectors

FLANGE CONNECTORS

With multi-strand wire

– M12



Flange male

Front mounting

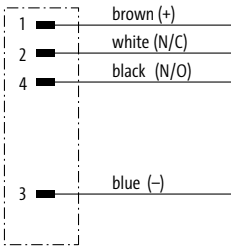
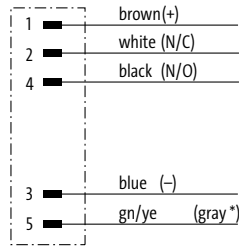
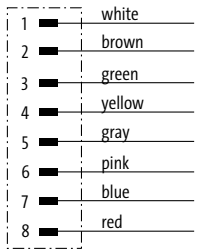

Approvals: 

Flange Connectors

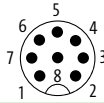
1 Form	13501	13521	17161
Type	4-pole	5-pole	8-pole
Circuit diagram		 <p>(* for cable type 902 and 972)</p>	
Contact layout	<p>Male</p> 	<p>Male</p> 	<p>Male</p> 
2 Wires			
Wire diameter 0.34 mm ²	multi-colored	multi-colored	multi-colored
PUR		975 (972)	
PVC	901	902	
PP	971		
Wire diameter 0.25 mm ²			
PP			973
PVC			903
Hexagonal nut M16 × 1.5	7000-13581-0000000		
3 Wires Length			
0.2 m	0020		
0.5 m	0050		
1.0 m	0100		
Technical Data			
Operating voltage	max. 250 V AC/DC	max. 125 V AC/DC	max. 30 V AC/DC
Protection	IP67 inserted and tightened (EN 60529)		
Temperature range	-25...+85 °C		
Article No.			
The composition of your article number is explained on page 3.1.i	<div style="display: flex; justify-content: space-around; align-items: center;"> 7 0 0 0 - - </div>		
	1 Form	2 Wires	3 Wires Length
Notes	Other versions on request.		

FLANGE CONNECTORS

With multi-strand wire

- M12

Flange female

Front mounting



Approvals:

1 Form	13541	13561	17181
Type	4-pole	5-pole	8-pole
Circuit diagram		<p>(* for cable type 902, 972)</p>	
Contact layout	<p>Female</p>	<p>Female</p>	<p>Female</p>
2 Wires			
Wire diameter 0.34 mm ²	multi-colored	multi-colored	multi-colored
PUR		975 (972)	
PVC	901	902	
PP	971		
Wire diameter 0.25 mm ²			
PP			973
PVC			903
3 Wires Length			
0.2 m	0020		
0.5 m	0050		
1.0 m	0100		
Technical Data			
Operating voltage	max. 250 V AC/DC	max. 125 V AC/DC	max. 30 V AC/DC
Protection	IP67 inserted and tightened (EN 60529)		
Temperature range	-25...+85 °C		
Article No.			
The composition of your article number is explained on page 3.1.i	<div style="display: flex; justify-content: space-around; align-items: center;"> 7 0 0 0 - - </div>		
	1 Form	2 Wires	3 Wires Length
Notes	Other versions on request.		

Flange Connectors

FLANGE CONNECTORS

With multi-strand wire

- 7/8"

Flange male
Front mounting



Flange female
Front mounting



1 Form		78341	78381
Type		5-pole	5-pole
Circuit diagram			
Contact layout			
2 Wires			
5 x AWG18		multi-colored	multi-colored
PVC		978	978
Hexagonal nut PG 13.5		7000-78391-0000000	
3 Wires Length			
0.2 m		0020	
0.5 m		0050	
1.0 m		0100	
Technical Data			
Operating voltage		max. 300 V AC/DC	
Protection		IP68 inserted and tightened (EN 60529)	
Temperature range		-25...+85 °C	
Article No.			
The composition of your article number is explained on page 3.1.i		<div style="display: flex; align-items: center; gap: 10px;"> 7 0 0 0 - - </div>	<div style="border-bottom: 1px dashed black; padding: 0 5px;"> </div>
		1 Form	2 Wires
			3 Wires Length
Notes		Other versions on request.	

Flange Connectors

FLANGE CONNECTORS

With multi-strand wire

– M12 Power

Approvals: 

Flange male

Front mounting



Flange female

Front mounting

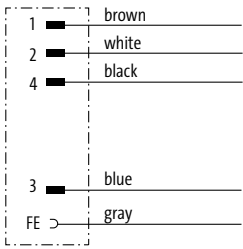
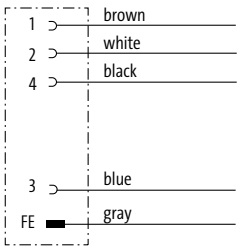
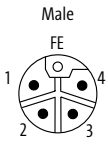
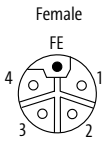

1 Form	P4281	P4291
Type	5-pole L-coded	5-pole L-coded
Circuit diagram		
Contact layout	<p>Male</p> 	<p>Female</p> 
2 Wires		
Wire diameter 1.5 mm ² PUR	multi-colored 980	multi-colored 980
3 Wires Length		
0.2 m	0020	
0.5 m	0050	
1.0 m	0100	
Technical Data		
Operating voltage	max. 63 V AC/DC	
Protection	IP65 and IP67 when plugged and screwed down (EN 60529)	
Temperature range	-25...+85 °C, depending on cable quality	
Article No.		
The composition of your article number is explained on page 3.1.i	<div style="display: flex; justify-content: space-around; align-items: center;"> 7 0 0 0 - - - - - - </div>	
	1 Form	2 Wires
	3 Wires Length	
Notes		
	Other versions on request.	

FLANGE CONNECTORS

With multi-strand wire

– M12 Power

Approvals: 

Flange male

Front mounting



Flange female

Front mounting

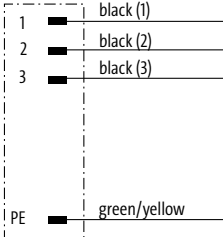
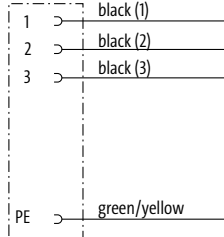
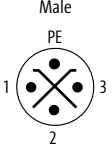
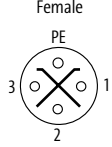

1 Form	P 6281	P 6291
Type	4-pole S-coded	4-pole S-coded
Circuit diagram		
Contact layout	<p>Male</p> 	<p>Female</p> 
2 Wires		
Wire diameter 1.5 mm ² mPPE	multi-colored 940	multi-colored 940
3 Wires Length		
0.2 m 0.5 m 1.0 m 1.5 m	0020 0050 0100 0150	
Technical Data		
Operating voltage	max. 630 V AC/DC	
Protection	IP67 inserted and tightened (EN 60529)	
Temperature range	-40...+85 °C, depending on cable quality	
Article No.		
The composition of your article number is explained on page 3.1.i	<div style="display: flex; align-items: center; justify-content: center;"> 7 0 0 0 - - - - - - </div>	
	1 Form	2 Wires
	3 Wires Length	
Notes	Other versions on request.	

FLANGE CONNECTORS

With multi-strand wire

– M12 Power

Flange male

Front mounting



Flange female

Front mounting



Approvals: e us

1 Form		P7281	P7291
Type		4-pole T-coded	4-pole T-coded
Circuit diagram			
Contact layout		<p>Male</p>	<p>Female</p>
2 Wires			
Wire diameter 1.5 mm ² PVC		multi-colored 941	multi-colored 941
3 Wires Length			
.2 m		0020	
.5 m		0050	
1.0 m		0100	
Technical Data			
Operating voltage		max. 63 V AC/DC	
Protection		IP67 inserted and tightened (EN 60529)	
Temperature range		-40...+85 °C, depending on cable quality	
Article No.			
The composition of your article number is explained on page 3.1.i		<u>7</u> <u>0</u> <u>0</u> <u>0</u> -	- - - - - - - - - - - - - - - - - - - -
		1 Form	2 Wires
			3 Wires Length
Notes		Other versions on request.	

FLANGE CONNECTORS

With multi-strand wire

– MQ15 X-Power

Flange male

Front mounting



Flange Connectors

1 Form	P 8181	P 8081	P 8081
Type	6-pole max. 16 A (Power); max. 10 A (Signal)	4-pole Operating current: max. 13 A	4-pole Operating current: max. 16 A
Circuit diagram			
Contact layout			
2 Wires			
Wire diameter 2.5 mm ²	multi-colored	multi-colored	multi-colored
PVC (UL)	P80		P82
Wire diameter 1.5 mm ²			
PVC (UL)		P81	
3 Wires Length			
0.25 m	0025		
0.5 m	0050		
1.0 m	0100		
Technical Data			
Operating voltage	max. 600 V AC (Power); max. 63 V AC/DC (Signal)	max. 600 V AC	
Protection	IP67 inserted and tightened (EN 60529)		
Temperature range	-40...+70 °C, depending on cable quality		
Article No.			
The composition of your article number is explained on page 3.1.i	<div style="display: flex; justify-content: space-around; align-items: center;"> 7 0 0 0 - - </div>		
	1 Form	2 Wires	3 Wires Length
Notes	Other versions on request.		

FLANGE CONNECTORS

With multi-strand wire

– MQ15 X-Power

Flange female

Front mounting



1 Form	P8191	P8091
Type	6-pole max. 16 A (Power); max. 10 A (Signal)	4-pole Operating current: max. 13 A
Circuit diagram		
Contact layout		
2 Wires		
Wire diameter 2.5 mm ² PVC (UL)	multi-colored P80	multi-colored
Wire diameter 1.5 mm ² PVC (UL)		P81
3 Wires Length		
0.25 m	0025	
0.5 m	0050	
1.0 m	0100	
Technical Data		
Operating voltage	max. 600 V AC (Power); max. 63 V AC/DC (Signal)	max. 600 V AC
Protection	IP67 inserted and tightened (EN 60529)	
Temperature range	-40...+70 °C, depending on cable quality	-40...+90 °C, depending on cable quality
Article No.		
The composition of your article number is explained on page 3.1.i	<div style="display: flex; justify-content: space-around; align-items: center;"> 7 0 0 0 - - </div>	
	1 Form	2 Wires
		3 Wires Length
Notes	Other versions on request.	

FLANGE CONNECTORS

With multi-strand wire

– MQ15 X-Power

– shielded housing

Flange male

Front mounting



Flange Connectors

1 Form	P 8381	P 8281	P 8281
Type	6-pole max. 16 A (Power); max. 10 A (Signal)	4-pole Operating current: max. 13 A	4-pole Operating current: max. 16 A
Circuit diagram			
Contact layout			
2 Wires			
Wire diameter 2.5 mm ²	multi-colored	multi-colored	multi-colored
PVC (UL)	P80		P82
Wire diameter 1.5 mm ²			
PVC (UL)		P81	
3 Wires Length			
0.25 m	0025		
0.5 m	0050		
1.0 m	0100		
Technical Data			
Operating voltage	max. 600 V AC (Power); max. 63 V AC/DC (Signal)	max. 600 V AC	
Protection	IP67 inserted and tightened (EN 60529)		
Temperature range	-40...+90 °C, depending on cable quality		
Article No.			
The composition of your article number is explained on page 3.1.i	<div style="display: flex; justify-content: space-around; align-items: center;"> 7 0 0 0 - _ - _ _ _ </div>		
	1 Form	2 Wires	3 Wires Length
Notes	Other versions on request.		

FLANGE CONNECTORS

With multi-strand wire

- MQ15 X-Power
- shielded housing

Flange female

Front mounting



1 Form	P 8391	P 8291	P 8291
Type	6-pole max. 16 A (Power); max. 10 A (Signal)	4-pole Operating current: max. 13 A	4-pole Operating current: max. 16 A
Circuit diagram			
Contact layout			
2 Wires			
Wire diameter 2.5 mm ² PVC (UL)	multi-colored P80	multi-colored	multi-colored P82
Wire diameter 1.5 mm ² PVC (UL)		P81	
3 Wires Length			
0.25 m	0025		
0.5 m	0050		
1.0 m	0100		
Technical Data			
Operating voltage	max. 600 V AC (Power); max. 63 V AC/DC (Signal)	max. 600 V AC	
Protection	IP67 inserted and tightened (EN 60529)		
Temperature range	-40...+90 °C, depending on cable quality		-40...+70 °C, depending on cable quality
Article No.			
The composition of your article number is explained on page 3.1.i	<div style="display: flex; justify-content: space-around; align-items: center;"> 7 0 0 0 - - </div>		
	1 Form	2 Wires	3 Wires Length
Notes	Other versions on request.		

Flange Connectors

FLANGE CONNECTORS

Control cabinet entry system

– M12 - M12

Male/female



Flange Connectors

1 Form	42111	44111	46111	48111
Type	5-pole, shielded	5-pole, shielded B-coded	6-pole, shielded	8-pole, shielded
Circuit diagram				
Contact layout	<div style="display: flex; justify-content: space-around;"> <div style="text-align: center;">Male </div> <div style="text-align: center;">Female </div> </div>	<div style="display: flex; justify-content: space-around;"> <div style="text-align: center;">Male </div> <div style="text-align: center;">Female </div> </div>	<div style="display: flex; justify-content: space-around;"> <div style="text-align: center;">Male </div> <div style="text-align: center;">Female </div> </div>	<div style="display: flex; justify-content: space-around;"> <div style="text-align: center;">Male </div> <div style="text-align: center;">Female </div> </div>
Technical Data				
Operating voltage	max. 60 V AC/DC		max. 30 V AC/DC	
Rated surge voltage	1.5 kV		0.8 kV	
Operating current per contact	max. 4 A			max. 2 A
Material group	IEC 60664-1, category I			
Coding	A-coded	B-coded	A-coded	
Locking of ports	Screw thread M12 × 1 mm (recommended torque 0.6 Nm) self-securing			
Protection	IP65 and IP67 when plugged and screwed down (EN 60529)			
Material	Brass, nickel plated			
Temperature range	-25...+85 °C			
Article No.				
The composition of your article number is explained on page 3.1.i	<u>7</u> <u>0</u> <u>0</u> <u>0</u>	- - - -	- - - -	<u>0</u> <u>0</u> <u>0</u> <u>0</u>
	1 Form			
Notes	Other versions on request.			

FLANGE CONNECTORS

Control cabinet entry system

– M12 - M12

EtherCAT  EtherNet/IP

PROFI
NET

Male/female







Female/female



1 Form	47281	44611	51521
Type	8-pole, shielded Y-coded	4-pole, shielded D-coded	8-pole, shielded X-coded
Circuit diagram			
Contact layout	<p>Male Female</p>	<p>Female Female</p>	<p>Female Female</p>
Technical Data			
Operating voltage	max. 30 V DC	max. 60 V AC/DC	max. 50 V AC/60 V DC
Rated surge voltage	0.8 kV		
Operating current per contact	max. 6 A	max. 4 A	max. 0.5 A
Operating current per contact (Signal)	max. 0.5 A	–	
Material group	IEC 60664-1, category I	–	IEC 60664-1, category III
Transfer parameters	CAT5, Class D (ISO/IEC 11801:2002), (EN 50173-1)		CAT6, Class EA (ISO/IEC 11801:2002), (EN 50173-1)
Transfer rate	to 100 Mbit/s Full Duplex		GIGABIT
Coding	Y-coded	D-coded	X-coded
Locking of ports	Screw thread M12 × 1 mm (recommended torque 0.6 Nm) self-securing		
Compression gland	M16 (SW19)		
Protection	IP65 and IP67 when plugged and screwed down (EN 60529)	IP67 inserted and tightened (EN 60529)	
Material	Brass, nickel plated		
Temperature range	-25...+85 °C		-40...+85 °C
Article No.			
The composition of your article number is explained on page 3.1.i	<u>7</u> <u>0</u> <u>0</u> <u>0</u>	–	<u>0</u> <u>0</u> <u>0</u>
			<u>0</u> <u>0</u> <u>0</u> <u>0</u>
	1 Form		
Notes	Other versions on request.		

FLANGE CONNECTORS

Connection accessories			Art-No.
	Shielding plate	Quantity: 1 000 pcs.	7000-99951-000000
	Protection cap Flange M8 male	Quantity: 10 pcs.	7000-99901-000000
	Flange M12 male	Quantity: 10 pcs.	7000-99921-000000
	Protection cap Flange M8 female	Quantity: 10 pcs.	7000-99911-000000
			Flange M12 female Quantity: 10 pcs. 7000-99931-000000

Flange Connectors

THE MQ12 SYSTEM THE CLEVER SOLUTION

- Effective quick connection system
- Saves installation time – up to 80%
- Plug in, ¼ turn – done!

COMPATIBLE, QUICK AND SAFE

Simply clever – it's our quick connection system that doesn't require any changes on the sensor side. MQ12 is completely compatible and interchangeable with all standard systems.

More features:

- Fits on all existing sensor and distributor systems
- High resistance to shock and vibration
- IP67 sealed



Murrelektronik's Efficient
Quick Connection System

With Open Ended Wires

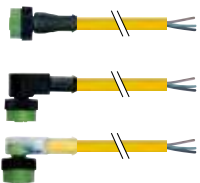

MQ12 female

- Straight
- 90°
- 90° with LED

Page 3.5.1

Connection Cables



MQ12 male

- Straight

MQ12 female

- Straight
- 90°
- 90° with LED

Page 3.5.3

Field-Wireable



Insulation Displacement Technology (IDC)

MQ12 male/female

- Straight

Page 3.5.5

MQ12 ROUND PLUG CONNECTORS

With open ended wires

- M12

Female
straight





Female
90°

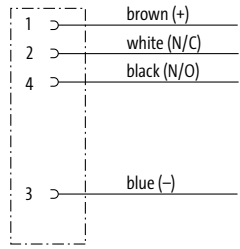

Approvals: 

* only for products with UL/CSA approved cable

1 Form		12221			12341		
Type	4-pole				4-pole		
Circuit diagram							
Contact layout	<p>Female</p> 						
2 Cable Type	Jacket Color			Jacket Color			
Wire diameter 0.34 mm ²	yellow	gray	black	yellow	gray	black	
PVC (UL/CSA)	014	214	614	014	214	614	
PUR/PVC (UL/CSA)	024	224	624	024	224	624	
PUR (UL/CSA), robots/Ctracks	034	234	634	034	234	634	
3 Cable Length							
1.5 m	0150						
3.0 m	0300						
5.0 m	0500						
7.5 m	0750						
10.0 m	1000						
Technical Data							
Operating voltage	max. 250 V AC/DC						
Protection	IP65 and IP67 when plugged and screwed down (EN 60529)						
Temperature range	-25...+85 °C, depending on cable quality						
Article No.							
The composition of your article number is explained on page 3.1.i	7 0 5 0			- - - - -			
	1 Form		2 Cable Type		3 Cable Length		
Notes	Other versions on request. Differing cable lengths up to 2 m can be ordered in 0.2 m steps, from 2 m on in 0.5 m steps.						

MQ12 ROUND PLUG CONNECTORS

With open ended wires

- M12

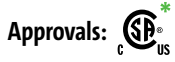

* only for products with UL/CSA approved cable

Female
90° with LED



1 Form 12421

Type **4-pole with 3 × LED (PNP)**
(NPN) on request

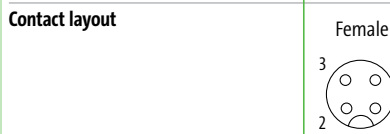
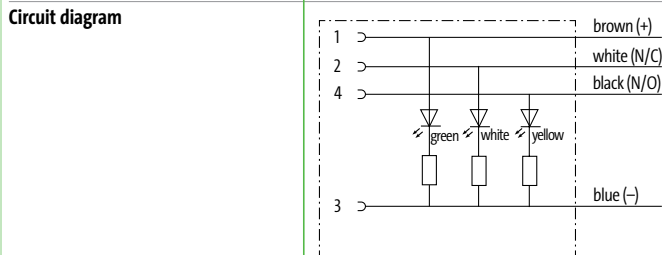

2 Cable Type Jacket Color

Wire diameter 0.34 mm ²	yellow	gray	black
PVC (UL/CSA)	014	214	614
PUR/PVC (UL/CSA)	024	224	624
PUR (UL/CSA), robots/Ctracks	034	234	634

3 Cable Length

1.5 m	0150
3.0 m	0300
5.0 m	0500
7.5 m	0750
10.0 m	1000

Technical Data

Operating voltage	24 V DC ±25%
Protection	IP65 and IP67 when plugged and screwed down (EN 60529)
Temperature range	-25...+85 °C, depending on cable quality

Article No.

The composition of your article number is explained on page 3.1.i

7 0 5 0 - 1 2 4 2 1 - _ _ _ _

1 Form **2** Cable Type **3** Cable Length

Notes

Other versions on request. Differing cable lengths up to 2 m can be ordered in 0.2 m steps, from 2 m on in 0.5 m steps.

MQ12 ROUND PLUG CONNECTORS

Connection cables

– M12 - M12

Male
straight

Female
straight

Male
straight

Female
90°



1 Form	4 0 0 2 1	4 0 1 2 1
Type	4-pole	4-pole
Circuit diagram		
Contact layout		
2 Cable Type	Jacket Color	Jacket Color
Wire diameter 0.34 mm ²	yellow	gray
PVC (UL/CSA)	014	214
PUR/PVC (UL/CSA)	024	224
PUR (UL/CSA), robots/Ctracks	034	234
	black	black
	614	614
	624	624
	634	634
3 Cable Length		
0.3 m	0030	
0.6 m	0060	
1.0 m	0100	
1.5 m	0150	
2.0 m	0200	
Technical Data		
Operating voltage	max. 250 V AC/DC	
Protection	IP65 and IP67 when plugged and screwed down (EN 60529)	
Temperature range	-25...+85 °C, depending on cable quality	
Article No.		
The composition of your article number is explained on page 3.1.i	7 0 5 0 - - - - -	- - - - -
	1 Form	2 Cable Type
		3 Cable Length
Notes	Other versions on request. Differing cable lengths up to 2 m can be ordered in 0.2 m steps, from 2 m on in 0.5 m steps.	

MQ12 ROUND PLUG CONNECTORS

Connection cables

– M12 - M12

Male

straight

Female

90° with LED



1 Form

40341

Type

4-pole with 3 × LED (PNP)
(NPN) on request

Circuit diagram

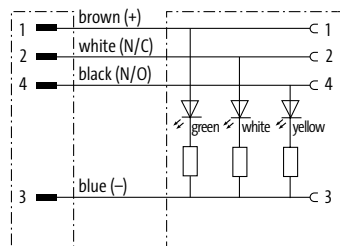

Contact layout

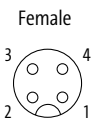
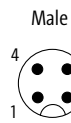

2 Cable Type

Jacket Color

Wire diameter 0.34 mm ²	yellow	gray	black
PVC (UL/CSA)	014	214	614
PUR/PVC (UL/CSA)	024	224	624
PUR (UL/CSA), robots/Ctracks	034	234	634

3 Cable Length

0.3 m	0030
0.6 m	0060
1.0 m	0100
1.5 m	0150
2.0 m	0200

Technical Data

Operating voltage	24 V DC ±25%
Protection	IP65 and IP67 when plugged and screwed down (EN 60529)
Temperature range	-25...+85 °C, depending on cable quality

Article No.

The composition of your article number is explained on page 3.1.i

7 0 5 0

-

4 0 3 4 1

-

1

Form

2

Cable Type

3

Cable Length

Notes

Other versions on request. Differing cable lengths up to 2 m can be ordered in 0.2 m steps, from 2 m on in 0.5 m steps.

MQ12 ROUND PLUG CONNECTORS

Field-wireable

– M12

– IDC terminals

Male

straight



Female

straight



1 Form	12461	12481	12581	12601													
Type	3-pole	4-pole	3-pole	4-pole													
Circuit diagram																	
Connection cross section	0.25...0.5 mm ²																
Contact layout	Male 	Male 	Female 	Female 													
Technical Data																	
Operating voltage	max. 32 V AC/DC																
Rated surge voltage	0.8 kV																
Operating current per contact	max. 4 A																
Material group	IEC 60664-1, category II																
Connection cross section	0.25...0.5 mm ² (conductor diameter min. 0.1 mm)																
Sealing range (cable Ø)	4...5.1 mm																
Wire isolation	PVC, PP, TPE																
Outer wire Ø	1.2...1.6 mm																
Protection	IP67 inserted and tightened (EN 60529)																
Temperature range	-25...+85 °C																
Article No.																	
The composition of your article number is explained on page 3.1.i	<table border="1"> <tr> <td><u>7</u></td><td><u>0</u></td><td><u>5</u></td><td><u>0</u></td> <td>-</td> <td>-</td> <td><u>0</u></td><td><u>0</u></td><td><u>0</u></td> <td><u>0</u></td><td><u>0</u></td><td><u>0</u></td><td><u>0</u></td> </tr> </table>				<u>7</u>	<u>0</u>	<u>5</u>	<u>0</u>	-	-	<u>0</u>	<u>0</u>	<u>0</u>	<u>0</u>	<u>0</u>	<u>0</u>	<u>0</u>
<u>7</u>	<u>0</u>	<u>5</u>	<u>0</u>	-	-	<u>0</u>	<u>0</u>	<u>0</u>	<u>0</u>	<u>0</u>	<u>0</u>	<u>0</u>					
	1 Form																
Notes	Other versions on request.																

MQ12 ROUND PLUG CONNECTORS

Field-wireable

– M12

– IDC terminals

Male
straight



Female
straight



1 Form

125 21

126 41

Type
Circuit diagram

4-pole

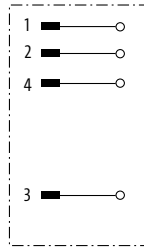

4-pole

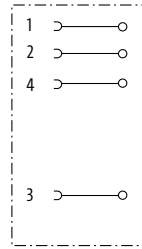

Connection cross section

0.5...1.0 mm²

Contact layout

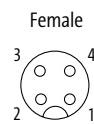
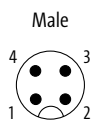

Technical Data

Operating voltage	max. 250 V AC/DC
Rated surge voltage	2.5 kV
Operating current per contact	max. 4 A
Material group	IEC 60664-1, category III
Connection cross section	0.5...1.0 mm ² (conductor diameter min. 0.1 mm)
Sealing range (cable Ø)	5.5...8 mm
Wire isolation	PVC, PP, TPE
Outer wire Ø	1.6...2.0 mm
Protection	IP67 inserted and tightened (EN 60529)
Temperature range	-25...+85 °C

Article No.

The composition of your article number is explained on page 3.1.i

7 0 5 0 – — — — —

0 0 0

0 0 0 0

1 Form

Notes

Other versions on request.

MQ12 ROUND PLUG CONNECTORS

Labeling accessories			Art-No.
	Slip-on cable sleeve for ACS label plates (4 × 18 mm)	Cable diameter (4...6.5 mm)	7000-99004-0000000
	Snap-on cable sleeve for ACS label plates (4 × 18 mm) for ACS label plates (4 × 18 mm)	Cable diameter (4.2...5.6 mm) Cable diameter (5...7 mm)	7000-99005-0000000 7000-99006-0000000
	ACS label plate for self marking (4 × 18 mm)		7000-99002-0000000
	Colored ring M8/M12 sandy yellow	for unshielded molding	7000-99301-V011002
	zinc yellow	for unshielded molding	7000-99301-V011018
	redorange	for unshielded molding	7000-99301-V012008
	red	for unshielded molding	7000-99301-V013020
	violet	for unshielded molding	7000-99301-V014003
	purple	for unshielded molding	7000-99301-V014006
	blue	for unshielded molding	7000-99301-V015005
	green	for unshielded molding	7000-99301-V016018
	gray	for unshielded molding	7000-99301-V017035
	white	for unshielded molding	7000-99301-V019003
	black	for unshielded molding	7000-99301-V019004
End fitting accessories			Art-No.
	Tube adapter snap-in for corrugated tube (size 13mm)	Cable diameter (4...7 mm)	7000-99081-0000000

MQ12 Round Plug Connectors



CONNECTORS FOR FIELDBUS

- Wide range of M8, M12 and RJ45 connectors
- 360° shielding
- Flex rated cables

FROM AS-INTERFACE TO ETHERNET TO PROFIBUS AND MORE...

Murrelektronik offers connection accessories for the fieldbus products. In addition to both field-wireable M12 and RJ45 connectors we have a wide range of pre-wired, molded models. Both the 15° locking mechanism and the PUR molding ensure an IP65/67 rated connection which make the connectors suitable for many rough industrial environments.



PROFIBUS



With open ended wires

M12 male/female (shielded)
• Straight/90°

Page 3.6.1

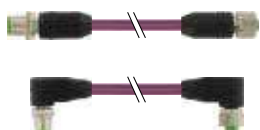

Connection Cables

M12 male – M12 female (shielded)
• Straight/90°

Page 3.6.3

DeviceNet, CANopen



With open ended wires

M12 male/female
• Straight/90°

Page 3.6.4

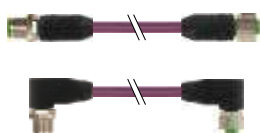

Connection Cables

M12 male – M12 female
• Straight/90°

Page 3.6.6

EtherNet, EtherCAT, PROFINET

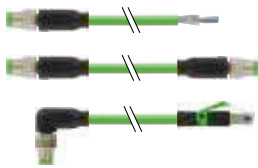

With open ended wires

M8 male/female (shielded)
• Straight/90°

Connection Cables

M8 male – M8 female/RJ45 male (shielded)
• Straight/90°

Page 3.6.7



With open ended wires

M8 female
• Straight/90°

Connection Cables

M8 male – M8 female
• Straight/90°

Page 3.6.10

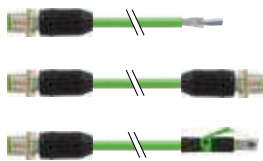

With open ended wires

M12 male/female (shielded)
• Straight/90°

Connection Cables

M12 male – M12 female/RJ45 male (shielded)
• Straight/90°

Page 3.6.12

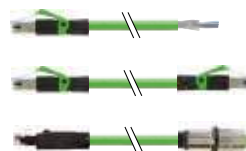

With open ended wires

RJ45 male (shielded)
• Straight/90°

Connection Cables

RJ45 male – RJ45 male/M12 female flange plug (shielded)
• Straight/90°

Page 3.6.21

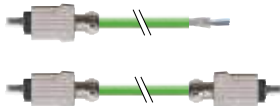

With open ended wires

RJ45 male Push Pull Power
• Straight

Connection Cables

RJ45 male Push Pull Power – RJ45 male Push Pull Power
• Straight

Page 3.6.26

Cube67

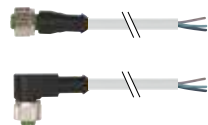

With open ended wires

M12 female
• Straight/90°

Page 3.6.28

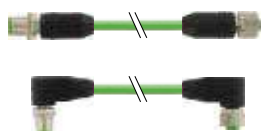

Connection Cables

M12 male – M12 female (shielded)
• Straight/90°

Page 3.6.29

AS-Interface

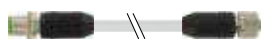

Connection Cables
for MASI68

M12 male – M12 female
• Straight

Page 3.6.30

FIELD BUS CONNECTORS

PROFIBUS

– with open ended wires M12



* only for products with UL/CSA approved cable

Male

straight



Male

90°



1 Form		14051	14081
Type		2-pole, shielded B-coded	2-pole, shielded B-coded
Circuit diagram			
Contact layout	<p>Male</p>		
2 Cable Type		Jacket Color	Jacket Color
1x2x0.25 mm ²		violet	violet
PUR (UL/CSA), C-tracks		841	841
PUR (UL/CSA), Highspeed C-track		840	840
PUR (UL/CSA), Torsion		843	843
PVC (UL), C-tracks		850	850
Terminator M12 (male)		7000-14041-0000000	
Control cabinet entry system M12		7000-44111-0000000	
3 Cable Length			
1.5 m		0150	
3.0 m		0300	
5.0 m		0500	
7.5 m		0750	
10.0 m		1000	
Technical Data			
Operating voltage		max. 60 V AC/DC	
Protection		IP65, IP66K, IP67 inserted and tightened (EN 60529)	
Temperature range		-25...+85 °C, depending on cable quality	
Article No.			
The composition of your article number is explained on page 3.1.i		7 0 0 0 - - - - - - - - - -	- - - - -
		1 Form	2 Cable Type 3 Cable Length
Notes			
		Other versions on request. Differing cable lengths up to 2 m can be ordered in 0.2 m steps, from 2 m on in 0.5 m steps. Connection accessories and general accessories can be found at the end of chapter 3.6.	

FIELDBUS CONNECTORS

PROFIBUS

– with open ended wires M12



* only for products with UL/CSA approved cable

Female
straight



Female
90°



1 Form

14061

14071

Type	2-pole, shielded B-coded	2-pole, shielded B-coded
Circuit diagram		
Contact layout	<p>Female</p>	

2 Cable Type

Jacket Color

Jacket Color

1x2x0.25 mm ²	violet	violet
PUR (UL/CSA), C-tracks	841	841
PUR (UL/CSA), Highspeed C-track	840	840
PUR (UL/CSA), Torsion	843	843
PVC (UL), C-tracks	850	850
Terminator M12 (male)	7000-14041-0000000	
Control cabinet entry system M12	7000-44111-0000000	

3 Cable Length

1.5 m	0150
3.0 m	0300
5.0 m	0500
7.5 m	0750
10.0 m	1000

Technical Data

Operating voltage	max. 60 V AC/DC
Protection	IP65, IP66K, IP67 inserted and tightened (EN 60529)
Temperature range	-25...+85 °C, depending on cable quality

Article No.

The composition of your article number is explained on page 3.1.i

7 0 0 0 - - - - -

1 Form

2 Cable Type

3 Cable Length

Notes

Other versions on request. Differing cable lengths up to 2 m can be ordered in 0.2 m steps, from 2 m on in 0.5 m steps. Connection accessories and general accessories can be found at the end of chapter 3.6.

FIELDBUS CONNECTORS

PROFIBUS

– Connection cables M12 - M12



* only for products with UL/CSA approved cable

Male
straight

Female
straight

Male
90°

Female
90°



1 Form	44001	44021
Type	2-pole, shielded B-coded	2-pole, shielded B-coded
Circuit diagram		
Contact layout		
2 Cable Type	Jacket Color	Jacket Color
1x2x0.25 mm ²	violet	violet
PUR (UL/CSA), C-tracks	841	841
PUR (UL/CSA), Highspeed C-track	840	840
PUR (UL/CSA), Torsion	843	843
PVC (UL), C-tracks	850	850
Terminator M12 (male)	7000-14041-0000000	
Control cabinet entry system M12	7000-44111-0000000	
3 Cable Length		
1.5 m	0150	
3.0 m	0300	
5.0 m	0500	
7.5 m	0750	
10.0 m	1000	
Technical Data		
Operating voltage	max. 60 V AC/DC	
Protection	IP65, IP66K, IP67 inserted and tightened (EN 60529)	
Temperature range	-25...+85 °C, depending on cable quality	
Article No.		
The composition of your article number is explained on page 3.1.i	<div style="display: flex; justify-content: space-around; align-items: center;"> 7 0 0 0 - _ - _ _ _ </div>	
	1 Form	2 Cable Type
		3 Cable Length
Notes	Other versions on request. Differing cable lengths up to 2 m can be ordered in 0.2 m steps, from 2 m on in 0.5 m steps. Connection accessories and general accessories can be found at the end of chapter 3.6.	

FIELDBUS CONNECTORS

DeviceNet, CANopen

– with open ended wires M12

DeviceNet CANopen



* only for products with UL/CSA approved cable

Male

straight



Male

90°



1 Form	Form	13105	13125									
	Type	5-pole	5-pole									
Circuit diagram												
	Contact layout	<p>Male</p>										
2 Cable Type	Cable Type	Jacket Color	Jacket Color									
	2x0.25 + 2x0.34 mm ² PUR (UL/CSA), C-tracks	<table border="1"> <tr> <td>black</td> <td>violet</td> </tr> <tr> <td>838</td> <td>803</td> </tr> </table>	black	violet	838	803	<table border="1"> <tr> <td>black</td> <td>violet</td> </tr> <tr> <td>838</td> <td>803</td> </tr> </table>	black	violet	838	803	
black	violet											
838	803											
black	violet											
838	803											
3 Cable Length	1.5 m	0150										
	3.0 m	0300										
	5.0 m	0500										
	7.5 m	0750										
	10.0 m	1000										
	Technical Data											
Operating voltage	max. 60 V AC/DC											
Protection	IP65, IP66K, IP67 inserted and tightened (EN 60529)											
Temperature range	-25...+85 °C, depending on cable quality											
Article No.												
The composition of your article number is explained on page 3.1.i	<table border="1"> <tr> <td><u>7</u></td> <td><u>0</u></td> <td><u>0</u></td> <td><u>0</u></td> <td>-</td> <td>---</td> <td>-</td> <td>---</td> <td>---</td> </tr> </table>			<u>7</u>	<u>0</u>	<u>0</u>	<u>0</u>	-	---	-	---	---
<u>7</u>	<u>0</u>	<u>0</u>	<u>0</u>	-	---	-	---	---				
	1	Form	2	Cable Type	3	Cable Length						
Notes	Other versions on request. Differing cable lengths up to 2 m can be ordered in 0.2 m steps, from 2 m on in 0.5 m steps. Connection accessories and general accessories can be found at the end of chapter 3.6.											

FIELD BUS CONNECTORS

DeviceNet, CANopen

– with open ended wires M12

DeviceNet **CANopen**



* only for products with UL/CSA approved cable

Female
straight



Female
90°



1 Form		13225	13251	
Type	5-pole		5-pole	
Circuit diagram				
Contact layout	<p>Female</p>			
2 Cable Type		Jacket Color		Jacket Color
2x0.25 + 2x0.34 mm ² PUR (UL/CSA), C-tracks		black 838	violet 803	black 838
Control cabinet entry system M12		7000-42111-0000000		
3 Cable Length				
1.5 m		0150		
3.0 m		0300		
5.0 m		0500		
7.5 m		0750		
10.0 m		1000		
Technical Data				
Operating voltage		max. 60 V AC/DC		
Protection		IP65, IP66K, IP67 inserted and tightened (EN 60529)		
Temperature range		-25...+85 °C, depending on cable quality		
Article No.				
The composition of your article number is explained on page 3.1.i		<p>7 0 0 0 - - - - - - - - - -</p>		
		1 Form	2 Cable Type	3 Cable Length
Notes		Other versions on request. Differing cable lengths up to 2 m can be ordered in 0.2 m steps, from 2 m on in 0.5 m steps. Connection accessories and general accessories can be found at the end of chapter 3.6.		

FIELDBUS CONNECTORS

DeviceNet, CANopen

– Connection cables M12 - M12

DeviceNet CANopen



* only for products with UL/CSA approved cable

Male

straight

Female

straight



Male

90°

Female

90°



1 Form	40531	40551								
	Type 5-pole	Type 5-pole								
Circuit diagram										
Contact layout										
2 Cable Type	Jacket Color	Jacket Color								
	2x0.25 + 2x0.34 mm ² PUR (UL/CSA), C-tracks	<table border="1"> <tr> <td>black</td> <td>violet</td> </tr> <tr> <td>838</td> <td>803</td> </tr> </table>	black	violet	838	803	<table border="1"> <tr> <td>black</td> <td>violet</td> </tr> <tr> <td>838</td> <td>803</td> </tr> </table>	black	violet	838
black	violet									
838	803									
black	violet									
838	803									
Control cabinet entry system M12	7000-42111-0000000									
3 Cable Length										
1.5 m	0150									
3.0 m	0300									
5.0 m	0500									
7.5 m	0750									
10.0 m	1000									
Technical Data										
Operating voltage	max. 60 V AC/DC									
Protection	IP65, IP66K, IP67 inserted and tightened (EN 60529)									
Temperature range	-25...+85 °C, depending on cable quality									
Article No.										
The composition of your article number is explained on page 3.1.i	<table border="1"> <tr> <td><u>7</u></td> <td><u>0</u></td> <td><u>0</u></td> <td><u>0</u></td> <td>-</td> <td>-</td> <td>-</td> <td>-</td> </tr> </table>		<u>7</u>	<u>0</u>	<u>0</u>	<u>0</u>	-	-	-	-
<u>7</u>	<u>0</u>	<u>0</u>	<u>0</u>	-	-	-	-			
	1 Form	2 Cable Type	3 Cable Length							
Notes	Other versions on request. Differing cable lengths up to 2 m can be ordered in 0.2 m steps, from 2 m on in 0.5 m steps. Connection accessories and general accessories can be found at the end of chapter 3.6.									

Fieldbus Connectors

FIELD BUS CONNECTORS

Industrial Ethernet

– with open ended wires M8

EtherCAT[®]



* only for products with UL/CSA approved cable

Male

straight



Male

90°

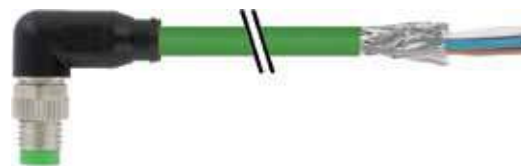

1 Form		08811	08821
Type	4-pole, shielded		4-pole, shielded
Circuit diagram			
Contact layout	<p>Male</p>		
2 Cable Type	Jacket Color	Jacket Color	
1x4x0.15 mm ² PUR (UL/CSA), Ctracks	green 791	green 791	
3 Cable Length			
1.5 m	0150		
3.0 m	0300		
5.0 m	0500		
7.5 m	0750		
10.0 m	1000		
Technical Data			
Operating voltage	max. 30 V AC/DC		
Protection	IP67 inserted and tightened (EN 60529)		
Temperature range	-25...+85 °C, depending on cable quality		
Article No.			
The composition of your article number is explained on page 3.1.i	<p>7 0 0 0 - - - - - - - - - -</p>		
	1 Form	2 Cable Type	3 Cable Length
Notes	Other versions on request. Differing cable lengths up to 2 m can be ordered in 0.2 m steps, from 2 m on in 0.5 m steps. Connection accessories and general accessories can be found at the end of chapter 3.6.		

FIELDBUS CONNECTORS

Industrial Ethernet

– Connection cables M8 - M8

EtherCAT

Approvals:  

* only for products with UL/CSA approved cable



Male
straight

Male
straight

Male
90°

Male
90°

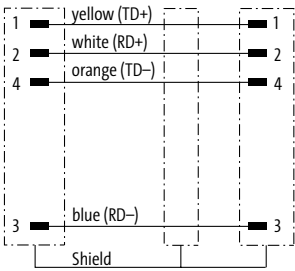
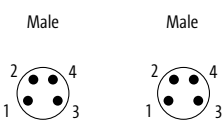

1 Form	Form	89701	89771
	Type	4-pole, shielded	4-pole, shielded
Circuit diagram			
			
2 Cable Type	Cable Type	Jacket Color	Jacket Color
	1x4x0.15 mm ² PUR (UL/CSA), C-tracks	green 791	green 791
3 Cable Length	Cable Length		
	1.5 m	0150	
	3.0 m	0300	
	5.0 m	0500	
	7.5 m	0750	
	10.0 m	1000	
Technical Data	Technical Data		
	Operating voltage	max. 50 V AC/60 V DC	
	Protection	IP67 inserted and tightened (EN 60529)	
	Temperature range	-25...+85 °C, depending on cable quality	
Article No.	Article No.		
	The composition of your article number is explained on page 3.1.i		
		1 Form	2 Cable Type
			3 Cable Length
Notes	Notes	Other versions on request. Differing cable lengths up to 2 m can be ordered in 0.2 m steps, from 2 m on in 0.5 m steps. Connection accessories and general accessories can be found at the end of chapter 3.6.	

Fieldbus Connectors

FIELDBUS CONNECTORS

Industrial Ethernet

– Connection cables M8 - RJ45

EtherCAT[®]

Approvals:  ^{*}
Listed

* only for products with UL/CSA approved cable

Male

straight

Male

straight

Male

90°

Male

straight



1 Form

89721

89781

Type

4-pole, shielded

4-pole, shielded

Circuit diagram

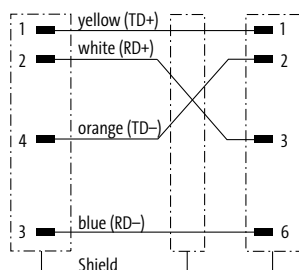

Contact layout

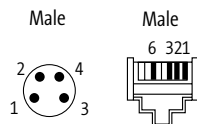

2 Cable Type

Jacket Color

Jacket Color

1x4x0.15 mm²

green

green

PUR (UL/CSA), C-tracks

791

791

3 Cable Length

1.5 m

0150

3.0 m

0300

5.0 m

0500

7.5 m

0750

10.0 m

1000

Technical Data

Operating voltage

max. 60 V DC

Protection

IP67 (M8) - IP20 (RJ45)

Temperature range

-25...+85 °C, depending on cable quality

Article No.

The composition of your article number is explained on page 3.1.i

7 0 0 0 - - - - -

1 Form

2 Cable Type

3 Cable Length

Notes

Other versions on request. Differing cable lengths up to 2 m can be ordered in 0.2 m steps, from 2 m on in 0.5 m steps.
Connection accessories and general accessories can be found at the end of chapter 3.6.

FIELDBUS CONNECTORS

Industrial Ethernet

– with open ended wires M8

– EtherCAT Power

EtherCAT 

Approvals: 

* only for products with UL/CSA approved cable

Female
straight



Female
90°



1 Form

08871

08881

Type
Circuit diagram

4-pole

4-pole

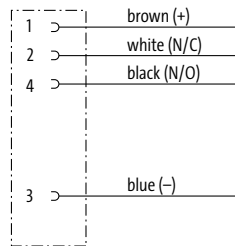

Contact layout

Female



2 Cable Type

Jacket Color

Jacket Color

Wire diameter 0.34 mm²
PUR (UL/CSA), robots/Ctracks

black
634

black
634

3 Cable Length

1.5 m	0150
3.0 m	0300
5.0 m	0500
7.5 m	0750
10.0 m	1000

Technical Data

Operating voltage	max. 50 V AC/60 V DC
Protection	IP65 and IP67 when plugged and screwed down (EN 60529)
Temperature range	-25...+85 °C, depending on cable quality

Article No.

The composition of your article number is explained on page 3.1.i

7 0 0 0

7 0 0 5

M8 Lite (plastic hexagonal screw) on request

1

Form

2

Cable Type

3

Cable Length

Notes

Other versions on request. Differing cable lengths up to 2 m can be ordered in 0.2 m steps, from 2 m on in 0.5 m steps. Connection accessories and general accessories can be found at the end of chapter 3.6.

FIELDBUS CONNECTORS

Industrial Ethernet

– Connection cables M8 - M8

– EtherCAT Power

EtherCAT 

Approvals: 

* only for products with UL/CSA approved cable

Male
straight

Female
straight

Male
90°

Female
90°



1 Form	89401	89431
Type	4-pole	4-pole
Circuit diagram		
Contact layout	<p>Male</p>	<p>Female</p>
2 Cable Type	Jacket Color	Jacket Color
Wire diameter 0.34 mm ² PUR (UL/CSA), robots/C/tracks	black 634	black 634
3 Cable Length		
1.5 m	0150	
3.0 m	0300	
5.0 m	0500	
7.5 m	0750	
10.0 m	1000	
Technical Data		
Operating voltage	max. 50 V AC/60 V DC	
Protection	IP65 and IP67 when plugged and screwed down (EN 60529)	
Temperature range	-25...+85 °C, depending on cable quality	
Article No.		
The composition of your article number is explained on page 3.1.i	<p>7 0 0 0 - - - - - - - - - -</p> <p>7 0 0 5 M8 Lite (plastic hexagonal screw) on request</p>	
	1 Form	2 Cable Type
		3 Cable Length
Notes	Other versions on request. Differing cable lengths up to 2 m can be ordered in 0.2 m steps, from 2 m on in 0.5 m steps. Connection accessories and general accessories can be found at the end of chapter 3.6.	

FIELDBUS CONNECTORS

Industrial Ethernet

– with open ended wires M12

EtherNet/IP EtherCAT

PROFINET

Approvals:  

* only for products with UL/CSA approved cable

Male

straight



Male

90°

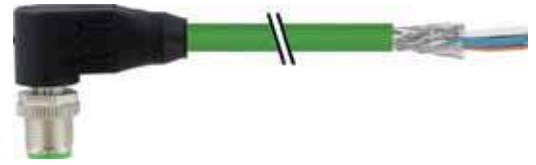

1 Form

14541 **14561**

Type: 4-pole, shielded D-coded

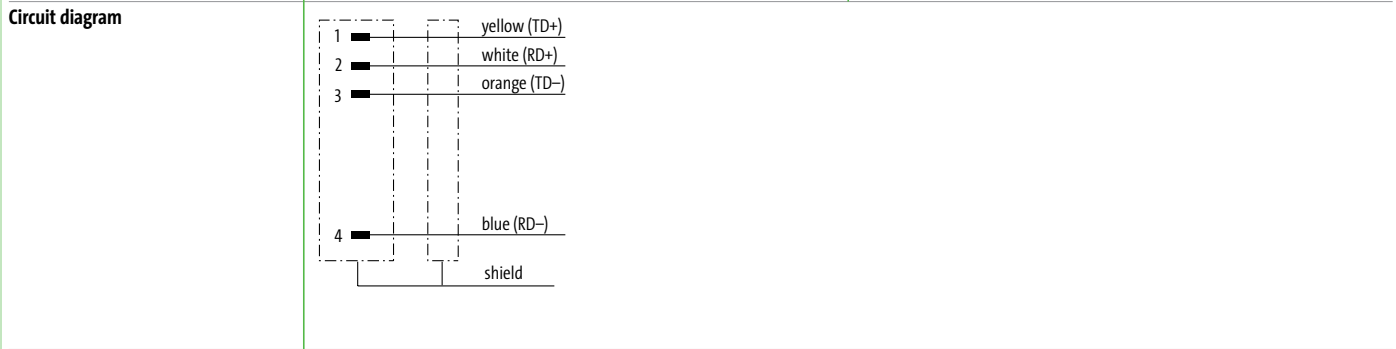

2 Cable Type

Cable Type	Jacket Color			Jacket Color		
	green	black	red	green	black	red
1x4x0.34 mm ² PVC (UL/CSA), C-tracks	800			800		
PUR (UL/CSA), Torsion	793			793		
2x2x0.34 mm ² PUR (UL/CSA)	794			794		
PUR (UL/CSA), robots/C-tracks	796	851	792	796	851	792
PUR (UL/CSA), C-tracks, 600 V	659			659		

3 Cable Length

1.5 m	0150
3.0 m	0300
5.0 m	0500
7.5 m	0750
10.0 m	1000

Technical Data

Operating voltage	max. 60 V DC
Protection	IP65, IP66K, IP67 inserted and tightened (EN 60529)
Temperature range	-25...+85 °C, depending on cable quality

Article No.

The composition of your article number is explained on page 3.1.i

7	0	0	0	0	-	-	-	-	-
1 Form			2 Cable Type			3 Cable Length			

Notes

Other versions on request. Differing cable lengths up to 2 m can be ordered in 0.2 m steps, from 2 m on in 0.5 m steps. Connection accessories and general accessories can be found at the end of chapter 3.6.

FIELDBUS CONNECTORS

Industrial Ethernet

– with open ended wires M12

– Hybrid cable

Male

straight



Female

straight



Approvals:  ^{*}
Listed

* only for products with UL/CSA approved cable

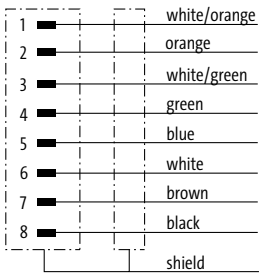
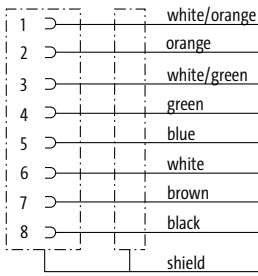
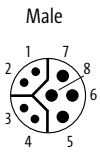
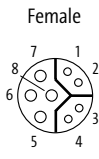
1 Form		15501	15551								
Type		8-pole, shielded Y-coded	8-pole, shielded Y-coded								
Circuit diagram											
Contact layout		<p>Male</p> 	<p>Female</p> 								
2 Cable Type		Jacket Color									
4×0.5 + 1×4×0.14 mm ² PUR (UL/CSA), robots/C/tracks		<table border="1"> <tr> <td>black</td> <td>green</td> </tr> <tr> <td>805</td> <td>831</td> </tr> </table>	black	green	805	831	<table border="1"> <tr> <td>black</td> <td>green</td> </tr> <tr> <td>805</td> <td>831</td> </tr> </table>	black	green	805	831
black	green										
805	831										
black	green										
805	831										
3 Cable Length											
1.5 m		0150									
3.0 m		0300									
5.0 m		0500									
7.5 m		0750									
10.0 m		1000									
Technical Data											
Operating voltage		max. 50 V AC/DC									
Protection		IP65 and IP67 when plugged and screwed down (EN 60529)									
Temperature range		-25...+85 °C, depending on cable quality									
Article No.											
The composition of your article number is explained on page 3.1.i		<table border="1"> <tr> <td><u>7</u></td> <td><u>0</u></td> <td><u>0</u></td> <td><u>0</u></td> <td>-</td> <td>-</td> <td>-</td> <td>-</td> </tr> </table>		<u>7</u>	<u>0</u>	<u>0</u>	<u>0</u>	-	-	-	-
<u>7</u>	<u>0</u>	<u>0</u>	<u>0</u>	-	-	-	-				
		1 Form	2 Cable Type	3 Cable Length							
Notes		Other versions on request. Differing cable lengths up to 2 m can be ordered in 0.2 m steps, from 2 m on in 0.5 m steps. Connection accessories and general accessories can be found at the end of chapter 3.6.									

FIELDBUS CONNECTORS

Industrial Ethernet

- with open ended wires M12
- Hybrid cable

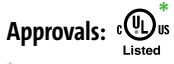

* only for products with UL/CSA approved cable

Male
90°

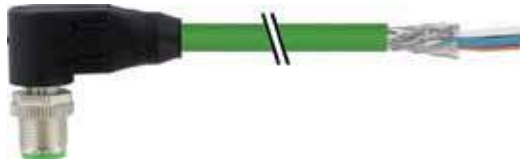

Female
90°

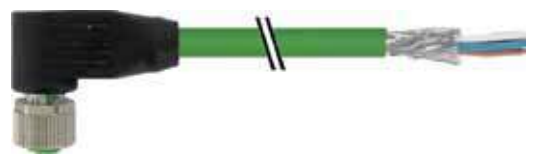

1 Form	15521	15571												
Type	8-pole, shielded Y-coded	8-pole, shielded Y-coded												
Circuit diagram														
Contact layout	<p>Male</p>	<p>Female</p>												
2 Cable Type	<p>Jacket Color</p> <table border="1"> <tr> <td>4×0.5 + 1×4×0.14 mm²</td> <td>black</td> <td>green</td> </tr> <tr> <td>PUR (UL/CSA), robots/Ctracks</td> <td>805</td> <td>831</td> </tr> </table>	4×0.5 + 1×4×0.14 mm ²	black	green	PUR (UL/CSA), robots/Ctracks	805	831	<p>Jacket Color</p> <table border="1"> <tr> <td></td> <td>black</td> <td>green</td> </tr> <tr> <td></td> <td>805</td> <td>831</td> </tr> </table>		black	green		805	831
4×0.5 + 1×4×0.14 mm ²	black	green												
PUR (UL/CSA), robots/Ctracks	805	831												
	black	green												
	805	831												
3 Cable Length	<table border="1"> <tr> <td>1.5 m</td> <td>0150</td> </tr> <tr> <td>3.0 m</td> <td>0300</td> </tr> <tr> <td>5.0 m</td> <td>0500</td> </tr> <tr> <td>7.5 m</td> <td>0750</td> </tr> <tr> <td>10.0 m</td> <td>1000</td> </tr> </table>		1.5 m	0150	3.0 m	0300	5.0 m	0500	7.5 m	0750	10.0 m	1000		
1.5 m	0150													
3.0 m	0300													
5.0 m	0500													
7.5 m	0750													
10.0 m	1000													
Technical Data	<table border="1"> <tr> <td>Operating voltage</td> <td>max. 50 V AC/DC</td> </tr> <tr> <td>Protection</td> <td>IP65 and IP67 when plugged and screwed down (EN 60529)</td> </tr> <tr> <td>Temperature range</td> <td>-25...+85 °C, depending on cable quality</td> </tr> </table>		Operating voltage	max. 50 V AC/DC	Protection	IP65 and IP67 when plugged and screwed down (EN 60529)	Temperature range	-25...+85 °C, depending on cable quality						
Operating voltage	max. 50 V AC/DC													
Protection	IP65 and IP67 when plugged and screwed down (EN 60529)													
Temperature range	-25...+85 °C, depending on cable quality													
Article No.	<p>The composition of your article number is explained on page 3.1.i</p> <p>7 0 0 0 - - - - -</p>													
	1 Form	2 Cable Type												
		3 Cable Length												
Notes	<p>Other versions on request. Differing cable lengths up to 2 m can be ordered in 0.2 m steps, from 2 m on in 0.5 m steps. Connection accessories and general accessories can be found at the end of chapter 3.6.</p>													

FIELDBUS CONNECTORS

Industrial Ethernet

– with open ended wires M12

– Gigabit Ethernet CAT6A

Male

straight



Male

90°

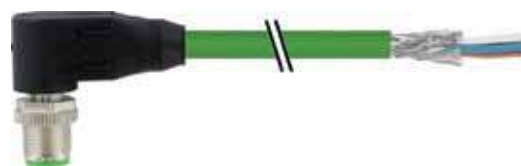

* only for products with UL/CSA approved cable

1 Form	21001	21021
Approvals	cULus *	
Type	8-pole, shielded X-coded	8-pole, shielded X-coded
Circuit diagram		
Contact layout	<p>Male</p>	
2 Cable Type	Jacket Color	Jacket Color
4x2x0.14 mm ² PUR (UL/CSA)	green 790	green 790
3 Cable Length		
1.5 m	0150	
3.0 m	0300	
5.0 m	0500	
7.5 m	0750	
10.0 m	1000	
Technical Data		
Operating voltage	max. 50 V AC/60 V DC	
Protection	IP65 and IP67 when plugged and screwed down (EN 60529)	
Temperature range	-25...+85 °C, depending on cable quality	
Article No.		
The composition of your article number is explained on page 3.1.i	<p>7 0 0 0 - - - - -</p>	
	1 Form	2 Cable Type
		3 Cable Length
Notes	<p>Other versions on request. Differing cable lengths up to 2 m can be ordered in 0.2 m steps, from 2 m on in 0.5 m steps. Connection accessories and general accessories can be found at the end of chapter 3.6.</p>	

FIELDBUS CONNECTORS

Industrial Ethernet

– Connection cables M12 - M12

EtherNet/IP EtherCAT

PROFI
NET

Approvals:  

* only for products with UL/CSA approved cable



1 Form	4 4 5 1 1	4 4 5 6 1	
	Type 4-pole, shielded D-coded Circuit diagram 	Type 4-pole, shielded D-coded	
Contact layout 			
2 Cable Type	Jacket Color	Jacket Color	
	1x4x0.34 mm ²	green black red	green black red
	PVC (UL/CSA), C-tracks	800	800
	PUR (UL/CSA), Torsion	793	793
	2x2x0.34 mm ²		
	PUR (UL/CSA)	794	794
PUR (UL/CSA), robots/C-tracks	796 851 792	796 851 792	
PUR (UL/CSA), C-tracks, 600 V	659	659	
3 Cable Length	1.5 m	0150	
	3.0 m	0300	
	5.0 m	0500	
	7.5 m	0750	
	10.0 m	1000	
	Technical Data		
Operating voltage	max. 60 V DC		
Protection	IP65, IP66K, IP67 inserted and tightened (EN 60529)		
Temperature range	-25...+85 °C, depending on cable quality		
Article No.			
The composition of your article number is explained on page 3.1.i	7 0 0 0 - - - - - - - - - -		
	1 Form	2 Cable Type	3 Cable Length
Notes	Other versions on request. Differing cable lengths up to 2 m can be ordered in 0.2 m steps, from 2 m on in 0.5 m steps. Connection accessories and general accessories can be found at the end of chapter 3.6.		

Fieldbus Connectors

FIELDBUS CONNECTORS

Industrial Ethernet

– Connection cables M12 - RJ45

EtherNet/IP EtherCAT

PROFINET

Approvals:  ^{*}
Listed

* only for products with UL/CSA approved cable

Male
straight

Male
straight

Male
straight

Male
45° on bottom



1 Form	44711	44731
Type	4-pole, shielded D-coded	4-pole, shielded D-coded

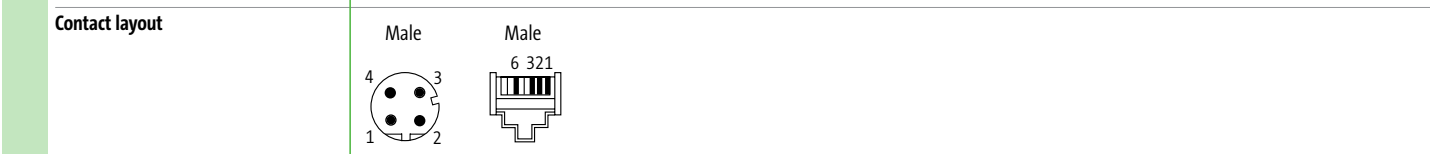
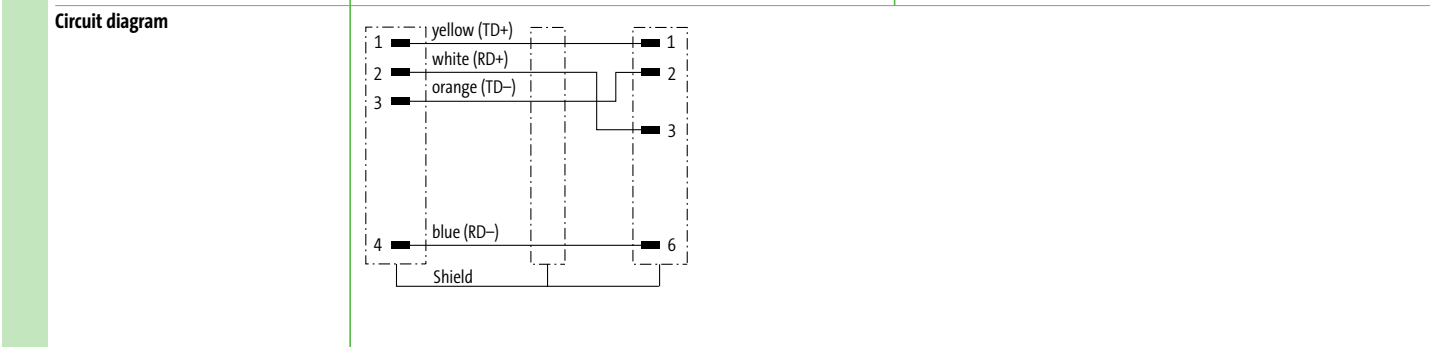

2 Cable Type	Jacket Color			Jacket Color		
	green	black	red	green	black	red
1×4×0.34 mm ² PVC (UL/CSA), C-tracks	800			800		
PUR (UL/CSA), Torsion	793			793		
2×2×0.34 mm ² PUR (UL/CSA)	794			794		
PUR (UL/CSA), robots/C-tracks	796	851	792	796	851	792
PUR (UL/CSA), C-tracks, 600 V	659			659		

3 Cable Length	
1.5 m	0150
3.0 m	0300
5.0 m	0500
7.5 m	0750
10.0 m	1000

Technical Data	
Operating voltage	max. 60 V DC
Protection	IP67 (M12) - IP20 (RJ45)
Temperature range	-25...+85 °C, depending on cable quality

Article No.	
The composition of your article number is explained on page 3.1.i	7 0 0 0 - - - - -

	1 Form	2 Cable Type	3 Cable Length
--	---------------	---------------------	-----------------------

Notes

Other versions on request. Differing cable lengths up to 2 m can be ordered in 0.2 m steps, from 2 m on in 0.5 m steps.
Connection accessories and general accessories can be found at the end of chapter 3.6.

FIELDBUS CONNECTORS

Industrial Ethernet

– Connection cables M12 - M12

– Hybrid cable

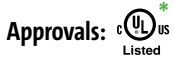

* only for products with UL/CSA approved cable

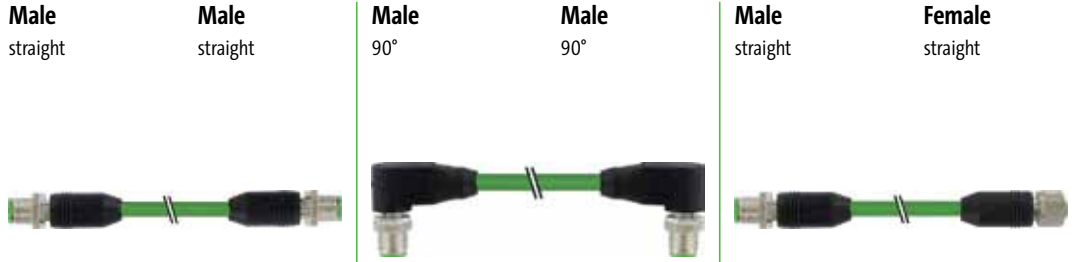

1 Form	47001	47021	47051										
Type	8-pole, shielded Y-coded	8-pole, shielded Y-coded	8-pole, shielded Y-coded										
Circuit diagram													
Contact layout													
2 Cable Type	Jacket Color	Jacket Color	Jacket Color										
4x0.5 + 1x4x0.14 mm ² PUR (UL/CSA), robots/Ctracks	<table border="1"> <tr> <td>black</td> <td>green</td> </tr> <tr> <td>805</td> <td>831</td> </tr> </table>	black	green	805	831	<table border="1"> <tr> <td>black</td> <td>green</td> </tr> <tr> <td>805</td> <td>831</td> </tr> </table>	black	green	805	831	<table border="1"> <tr> <td>green</td> </tr> <tr> <td>831</td> </tr> </table>	green	831
black	green												
805	831												
black	green												
805	831												
green													
831													
3 Cable Length	<table border="1"> <tr> <td>1.5 m</td> <td>0150</td> </tr> <tr> <td>3.0 m</td> <td>0300</td> </tr> <tr> <td>5.0 m</td> <td>0500</td> </tr> <tr> <td>7.5 m</td> <td>0750</td> </tr> <tr> <td>10.0 m</td> <td>1000</td> </tr> </table>			1.5 m	0150	3.0 m	0300	5.0 m	0500	7.5 m	0750	10.0 m	1000
1.5 m	0150												
3.0 m	0300												
5.0 m	0500												
7.5 m	0750												
10.0 m	1000												
Technical Data	<table border="1"> <tr> <td>Operating voltage</td> <td>max. 50 V AC/DC</td> </tr> <tr> <td>Protection</td> <td>IP65 and IP67 when plugged and screwed down (EN 60529)</td> </tr> <tr> <td>Temperature range</td> <td>-25...+85 °C, depending on cable quality</td> </tr> </table>			Operating voltage	max. 50 V AC/DC	Protection	IP65 and IP67 when plugged and screwed down (EN 60529)	Temperature range	-25...+85 °C, depending on cable quality				
Operating voltage	max. 50 V AC/DC												
Protection	IP65 and IP67 when plugged and screwed down (EN 60529)												
Temperature range	-25...+85 °C, depending on cable quality												
Article No.	<p>The composition of your article number is explained on page 3.1.i</p> <p>7 0 0 0 - - - - -</p>												
	1 Form	2 Cable Type	3 Cable Length										
Notes	<p>Other versions on request. Differing cable lengths up to 2 m can be ordered in 0.2 m steps, from 2 m on in 0.5 m steps. Connection accessories and general accessories can be found at the end of chapter 3.6.</p>												

Fieldbus Connectors

FIELDBUS CONNECTORS

Industrial Ethernet

- Connection cables M12 - M12
- Gigabit Ethernet CAT6A

Male
straight

Male
straight

Male
90°

Male
90°



* only for products with UL/CSA approved cable

1 Form	51001	51021
Approvals	cULus *	
Type	8-pole, shielded X-coded	8-pole, shielded X-coded
Circuit diagram		
Contact layout		
2 Cable Type	Jacket Color	Jacket Color
4x2x0.14 mm ² PUR (UL/CSA)	green 790	green 790
3 Cable Length		
1.5 m	0150	
3.0 m	0300	
5.0 m	0500	
7.5 m	0750	
10.0 m	1000	
Technical Data		
Operating voltage	max. 50 V AC/60 V DC	
Protection	IP65 and IP67 when plugged and screwed down (EN 60529)	
Temperature range	-25...+85 °C, depending on cable quality	
Article No.		
The composition of your article number is explained on page 3.1.i	<div style="border: 1px solid black; padding: 5px; display: flex; justify-content: space-around;"> 7 0 0 0 - _____ - _____ - _____ </div>	
	1 Form	2 Cable Type
		3 Cable Length
Notes	Other versions on request. Differing cable lengths up to 2 m can be ordered in 0.2 m steps, from 2 m on in 0.5 m steps. Connection accessories and general accessories can be found at the end of chapter 3.6.	

FIELDBUS CONNECTORS

Industrial Ethernet

- Connection cables M12 - RJ45
- Gigabit Ethernet CAT6A

Male
straight

Male
straight

Male
straight

Flange female
straight



1 Form	51101	51551
	<p>Type</p> <p>8-pole, shielded</p> <p>X-coded</p>	<p>Type</p> <p>8-pole, shielded</p> <p>X-coded</p> <p>Rear mounting</p>
Circuit diagram		
Contact layout	<p>Male</p> <p>Male</p>	<p>Male</p> <p>Female</p>
2 Cable Type	Jacket Color	Jacket Color
<p>4×2×0.14 mm²</p> <p>PUR (UL/CSA)</p>	<p>green</p> <p>790</p>	<p>green</p> <p>790</p>
3 Cable Length		
1.5 m	0150	
3.0 m	0300	
5.0 m	0500	
7.5 m	0750	
10.0 m	1000	
Technical Data		
Operating voltage	max. 60 V DC	
Protection	IP67 (M12) - IP20 (RJ45)	
Temperature range	-25...+85 °C, depending on cable quality	
Article No.		
The composition of your article number is explained on page 3.1.i	<u>7</u> <u>0</u> <u>0</u> <u>0</u> - - - - - - - - - -	- - - - - - - - - -
	1 Form	2 Cable Type
		3 Cable Length
Notes	Other versions on request. Differing cable lengths up to 2 m can be ordered in 0.2 m steps, from 2 m on in 0.5 m steps. Connection accessories and general accessories can be found at the end of chapter 3.6.	

Fieldbus Connectors

FIELDBUS CONNECTORS

Industrial Ethernet

– with open ended wires RJ45

EtherNet/IP EtherCAT

PROFINET

Approvals:  ^{*}
Listed

* only for products with UL/CSA approved cable

Male
straight



Male
45° on top



Male
45° on bottom



1 Form	74101	74121	74141
Type	4-pole, shielded	4-pole, shielded	4-pole, shielded
Circuit diagram			
Contact layout			
2 Cable Type	Jacket Color	Jacket Color	Jacket Color
1×4×0.34 mm ²	green black red	green black red	green black red
PVC (UL/CSA), C-tracks	800	800	800
PUR (UL/CSA), Torsion	793	793	793
2×2×0.34 mm ²			
PUR (UL/CSA)	794	794	794
PUR (UL/CSA), robots/C-tracks	796 851 792	796 851 792	796 851 792
PUR (UL/CSA), C-tracks, 600 V	659	659	659
3 Cable Length			
1.5 m	0150		
3.0 m	0300		
5.0 m	0500		
7.5 m	0750		
10.0 m	1000		
Technical Data			
Operating voltage	max. 60 V DC		
Protection	IP20 inserted and tightened (EN 60529)		
Temperature range	-25...+85 °C, depending on cable quality		
Article No.			
The composition of your article number is explained on page 3.1.i	<div style="display: flex; justify-content: space-around; align-items: center;"> 7 0 0 0 - - </div>		
	1	2	3
	Form	Cable Type	Cable Length
Notes	Other versions on request. Differing cable lengths up to 2 m can be ordered in 0.2 m steps, from 2 m on in 0.5 m steps. Connection accessories and general accessories can be found at the end of chapter 3.6.		

FIELDBUS CONNECTORS

Industrial Ethernet

– with open ended wires RJ45

EtherNet/IP EtherCAT

PROFINET

Approvals:  ^{*}
Listed

* only for products with UL/CSA approved cable

Male

45° left



Male

45° right

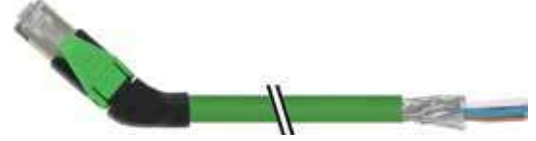

1 Form	Form	74161	74181
	Type	4-pole, shielded	4-pole, shielded
2 Cable Type	Circuit diagram		
	Contact layout		
3 Cable Length	Cable Type	Jacket Color	Jacket Color
	1x4x0.34 mm ²	green black red	green black red
	PVC (UL/CSA), C-tracks	800	800
	PUR (UL/CSA), Torsion	793	793
	2x2x0.34 mm ²		
	PUR (UL/CSA)	794	794
	PUR (UL/CSA), robots/C-tracks	796 851 792	796 851 792
PUR (UL/CSA), C-tracks, 600 V	659	659	
Technical Data	Article No.	<div style="display: flex; justify-content: space-between; align-items: center;"> <u>7</u> <u>0</u> <u>0</u> <u>0</u> - _____ - _____ - _____ </div>	
	Operating voltage	max. 60 V DC	
	Protection	IP20 inserted and tightened (EN 60529)	
	Temperature range	-25...+85 °C, depending on cable quality	
	The composition of your article number is explained on page 3.1.i	<div style="display: flex; justify-content: space-between; align-items: center;"> 1 Form 2 Cable Type 3 Cable Length </div>	
Notes	Other versions on request. Differing cable lengths up to 2 m can be ordered in 0.2 m steps, from 2 m on in 0.5 m steps. Connection accessories and general accessories can be found at the end of chapter 3.6.		

FIELDBUS CONNECTORS

Industrial Ethernet

– Connection cables RJ45 - RJ45

EtherNet/IP EtherCAT

PROFINET

Approvals:  ^{*}
Listed

* only for products with UL/CSA approved cable

Male

straight

Male

straight

Male

45° on bottom

Male

45° right



1 Form	74301	74521
---------------	--------------	--------------

Type	4-pole, shielded	4-pole, shielded
------	------------------	------------------

Circuit diagram		
Contact layout		

2 Cable Type	Jacket Color	Jacket Color
---------------------	---------------------	---------------------

1×4×0.34 mm ²	green	black	red	green	black	red
PVC (UL/CSA), C-tracks	800			800		
PUR (UL/CSA), Torsion	793			793		
2×2×0.34 mm ²						
PUR (UL/CSA)	794			794		
PUR (UL/CSA), robots/C-tracks	796	851	792	796	851	792
PUR (UL/CSA), C-tracks, 600 V	659			659		

3 Cable Length	
-----------------------	--

1.5 m	0150
3.0 m	0300
5.0 m	0500
7.5 m	0750
10.0 m	1000

Technical Data	
-----------------------	--

Operating voltage	max. 60 V DC
Protection	IP20 inserted and tightened (EN 60529)
Temperature range	-25...+85 °C, depending on cable quality

Article No.	
--------------------	--

The composition of your article number is explained on page 3.1.i	7 0 0 0 - - - - -
---	-------------------

1 Form	2 Cable Type	3 Cable Length
---------------	---------------------	-----------------------

Notes	
--------------	--

Other versions on request. Differing cable lengths up to 2 m can be ordered in 0.2 m steps, from 2 m on in 0.5 m steps. Connection accessories and general accessories can be found at the end of chapter 3.6.

FIELDBUS CONNECTORS

Industrial Ethernet

- Connection cables RJ45 - RJ45
- Gigabit Ethernet CAT6A

Male
straight

Male
straight



1 Form

74311

Type

8-pole, shielded

Circuit diagram

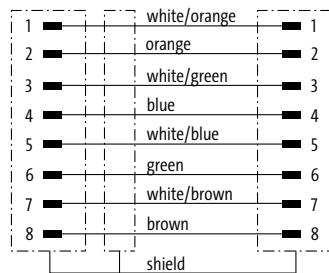

Contact layout

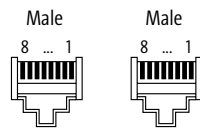

2 Cable Type

Jacket Color

4x2x0.14 mm²
PUR (UL/CSA)

green
790

3 Cable Length

1.5 m	0150
3.0 m	0300
5.0 m	0500
7.5 m	0750
10.0 m	1000

Technical Data

Operating voltage	max. 60 V DC
Protection	IP20 inserted and tightened (EN 60529)
Temperature range	-25...+85 °C, depending on cable quality

Article No.

The composition of your article number is explained on page 3.1.i

7 0 0 0

-

7 4 3 1 1

-

1 Form

2 Cable Type

3 Cable Length

Notes

Other versions on request. Differing cable lengths up to 2 m can be ordered in 0.2 m steps, from 2 m on in 0.5 m steps. Connection accessories and general accessories can be found at the end of chapter 3.6.

FIELDBUS CONNECTORS

Cabinetline

– Connection cables RJ45 - RJ45

Male
straight

Male
straight

Male
straight

Male
straight



1 Form	74701	74711		
Type	4-pole, shielded	8-pole, shielded		
Circuit diagram				
Contact layout				
2 Cable Type	Jacket Color	Jacket Color		
4×2×0.14 mm ² FRNC	gray	green	black	red
2×2×0.14 mm ² FRNC, Ctracks	777	478	380	578
3 Cable Length				
1.5 m	0150			
3.0 m	0300			
5.0 m	0500			
7.5 m	0750			
10.0 m	1000			
Technical Data				
Operating voltage	max. 60 V DC			
Protection	IP20 inserted and tightened (EN 60529)			
Temperature range	-25...+85 °C, depending on cable quality			
Article No.				
The composition of your article number is explained on page 3.1.i	7 0 0 0	-	-	-
	1	2	3	
	Form	Cable Type	Cable Length	
Notes				
	Other versions on request. Differing cable lengths up to 2 m can be ordered in 0.2 m steps, from 2 m on in 0.5 m steps. Connection accessories and general accessories can be found at the end of chapter 3.6.			

FIELDBUS CONNECTORS

Ethernet CAT5e

– Push Pull RJ45

– AIDA conform



Approvals: ^{*}

* only for products with UL/CSA approved cable

Male
straight



Male
straight



Male
straight

1 Form

74601

74641

Type
Circuit diagram

4-pole, shielded

4-pole, shielded

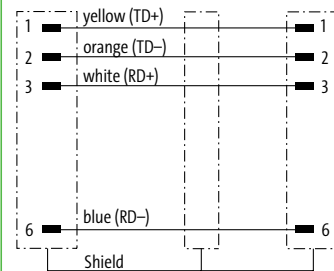
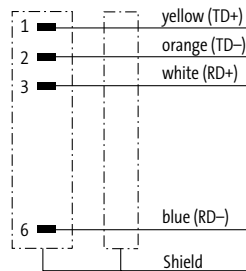

Contact layout

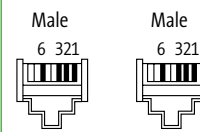
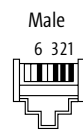

2 Cable Type

Jacket Color

Jacket Color

2x2x0.34 mm²
PUR (UL/CSA)
PUR (UL/CSA), robots/Ctracks

green
794
796

green
794
796

3 Cable Length

1.5 m **0150**
3.0 m **0300**
5.0 m **0500**
7.5 m **0750**
10.0 m **1000**

Technical Data

Operating voltage max. 60 V DC
Protection IP65 and IP67 when plugged and screwed down (EN 60529)
Temperature range -25...+85 °C, depending on cable quality

Article No.

The composition of your article number is explained on page 3.1.i

7 0 0 0 - - - -

1 Form

2 Cable Type

3 Cable Length

Notes

Other versions on request. Further cable lengths on request.
Connection accessories and general accessories can be found at the end of chapter 3.6.

FIELDBUS CONNECTORS

Push Pull Power

Male

straight



Male

straight



Male

straight

1 Form		99621	99641
Type	5-pole	5-pole	5-pole
Circuit diagram			
Contact layout			
2 Cable Type		Jacket Color	
Wire diameter 2.5 mm ² PUR (UL/CSA), robots/Ctracks	gray 962	gray 962	gray 962
3 Cable Length			
1.5 m	0150		
3.0 m	0300		
5.0 m	0500		
7.5 m	0750		
10.0 m	1000		
Technical Data			
Operating voltage	max. 24 V AC/DC		
Protection	IP65 and IP67 when plugged and screwed down (EN 60529)		
Temperature range	-40...+85 °C, depending on cable quality		
Article No.			
The composition of your article number is explained on page 3.1.i	7 0 0 0 - - - - -	- - - - -	- - - - -
	1 Form	2 Cable Type	3 Cable Length
Notes			
		Other versions on request. Further cable lengths on request. Connection accessories and general accessories can be found at the end of chapter 3.6.	

FIELDBUS CONNECTORS

Cube67

- with open ended wires M12
- Actuator supply external



* only for products with UL/CSA approved cable

Female
straight



Female
90°



1 Form	Form	15001	15021
	Type	2-pole	2-pole
	Circuit diagram		
2 Cable Type	Contact layout	Female 	
	Wire diameter 0.5 mm ² PUR (UL/CSA), robots/C/tracks	Jacket Color gray 414	Jacket Color gray 414
3 Cable Length	1.5 m	0150	
	3.0 m	0300	
	5.0 m	0500	
	7.5 m	0750	
	10.0 m	1000	
	Technical Data	Operating voltage: max. 30 V AC/DC Protection: IP67 inserted and tightened (EN 60529) Temperature range: -25...+85 °C, depending on cable quality	
Article No.	The composition of your article number is explained on page 3.1.i <div style="display: flex; justify-content: space-around; align-items: center;"> <u>7</u> <u>0</u> <u>0</u> <u>0</u> - - - </div> <div style="display: flex; justify-content: space-around; align-items: center; margin-top: 5px;"> <u>7</u> <u>0</u> <u>0</u> <u>5</u> M12 Lite (plastic hexagonal screw) on request </div>		
	1 Form	2 Cable Type	3 Cable Length
Notes	Other versions on request. Differing cable lengths up to 2 m can be ordered in 0.2 m steps, from 2 m on in 0.5 m steps. Connection accessories and general accessories can be found at the end of chapter 3.6.		

FIELDBUS CONNECTORS

Cube67

– Connection cables M12 - M12

– Hybrid cable

Male
straight

Female
straight

Male
90°

Female
90°



Approvals:

* only for products with UL/CSA approved cable

1 Form	46041	46061
Type	6-pole, shielded	6-pole, shielded
Circuit diagram		
Contact layout		
2 Cable Type	Jacket Color	Jacket Color
4x0.5 + 2x0.25 mm ²	green	green
PUR (UL/CSA), robots/C-tracks	802	802
Terminator M12 (male)	7000-15041-0000000	
Control cabinet entry system M12	7000-46111-0000000	
T-coupler M12/M12, female/male	7000-46101-0000000	
3 Cable Length		
1.5 m	0150	
3.0 m	0300	
5.0 m	0500	
7.5 m	0750	
10.0 m	1000	
Technical Data		
Operating voltage	max. 30 V AC/DC	
Protection	IP65 and IP67 when plugged and screwed down (EN 60529)	
Temperature range	-25...+85 °C, depending on cable quality	
Article No.		
The composition of your article number is explained on page 3.1.i	<div style="display: flex; justify-content: space-around; align-items: center;"> 7 0 0 0 - _ - _ _ _ </div>	
	1 Form	2 Cable Type
		3 Cable Length
Notes	Other versions on request. Differing cable lengths up to 2 m can be ordered in 0.2 m steps, from 2 m on in 0.5 m steps. Connection accessories and general accessories can be found at the end of chapter 3.6.	

FIELDBUS CONNECTORS

AS-Interface

– Connection cables M12 - M12

– for MASI68



* only for products with UL/CSA approved cable

Male

straight

Female

straight



1 Form	40005	40021
Type	2-pole	4-pole
Circuit diagram		
Contact layout		
2 Cable Type	Jacket Color	Jacket Color
Wire diameter 1.5 mm ² PUR (UL/CSA), robots/C-tracks	gray 588	gray
Wire diameter 0.75 mm ² PUR (UL/CSA), robots/C-tracks		862
3 Cable Length		
1.5 m	0150	
3.0 m	0300	
5.0 m	0500	
7.5 m	0750	
10.0 m	1000	
Technical Data		
Operating voltage	max. 250 V AC/DC	
Protection	IP67/IP68 inserted and tightened (EN 60529)	
Temperature range	-25...+85 °C, depending on cable quality	
Article No.		
The composition of your article number is explained on page 3.1.i	7 0 6 0 - - - - -	- - - - -
	1 Form	2 Cable Type 3 Cable Length
Notes	Other versions on request. Differing cable lengths up to 2 m can be ordered in 0.2 m steps, from 2 m on in 0.5 m steps. Connection accessories and general accessories can be found at the end of chapter 3.6.	

FIELDBUS CONNECTORS

Connection accessories			Art-No.
	T-coupler M12 – M12 Male straight - female/male straight straight, B-coded, 5-pole, shielded	PROFIBUS	7000-44151-0000000
	T-coupler M12 – M12 Female straight - male/female straight straight, B-coded, 5-pole, shielded	PROFIBUS	7000-44161-0000000
	T-coupler M12 – M12 Male straight - female straight straight, A-coded, 6-pole, shielded	Cube67 additional actuator power supply	7000-46101-0000000
	T-coupler M12 – M12 Female straight - male/male straight straight, A-coded, 4-pole	MASI68 additional actuator power supply	7060-42701-0000000
	Male M12, field-wireable, screw terminals straight, B-coded, 5-pole, shielded	PROFIBUS, Interbus Sealing range (cable Ø): 6...8 mm	7000-14001-0000000
	Female M12, field-wireable, screw terminals straight, B-coded, 5-pole, shielded	PROFIBUS, Interbus Sealing range (cable Ø): 6...8 mm	7000-14021-0000000
	Male M12, field-wireable, screw terminals 90°, B-coded, 5-pole, shielded	PROFIBUS, Interbus Sealing range (cable Ø): 6...8 mm	7000-14011-0000000
	90°, D-coded, 4-pole, shielded	Ethernet CAT5 Sealing range (cable Ø): 6...8 mm	7000-14581-0000000
	Female M12, field-wireable, screw terminals 90°, B-coded, 5-pole, shielded	PROFIBUS, Interbus Sealing range (cable Ø): 6...8 mm	7000-14031-0000000
	Male M12, field-wireable, IDC terminals straight, B-coded, 3-pole, shielded	PROFIBUS Sealing range (cable Ø): 7...8.8 mm	7000-14201-0000000
	straight, D-coded, 4-pole, shielded	Ethernet CAT5 Sealing range (cable Ø): 4.5...8.8 mm	7000-14521-0000000
	Female M12, field-wireable, IDC terminals straight, B-coded, 3-pole, shielded	PROFIBUS Sealing range (cable Ø): 7...8.8 mm	7000-14221-0000000
	straight, D-coded, 4-pole, shielded	Ethernet CAT5 Sealing range (cable Ø): 4.5...8.8 mm	7000-14621-0000000

FIELDBUS CONNECTORS

Connection accessories			Art-No.
	Male M12, field-wireable, screw terminals straight, A-coded, 5-pole	DeviceNet, CANopen Sealing range (cable Ø): 6...8 mm	7000-12761-0000000
	Female M12, field-wireable, screw terminals straight, A-coded, 5-pole	DeviceNet, CANopen Sealing range (cable Ø): 6...8 mm	7000-12961-0000000
	Male M12, field-wireable, screw terminals 90°, A-coded, 5-pole	DeviceNet, CANopen Sealing range (cable Ø): 6...8 mm	7000-12881-0000000
	Female M12, field-wireable, screw terminals 90°, A-coded, 5-pole	DeviceNet, CANopen Sealing range (cable Ø): 6...8 mm	7000-13041-0000000
	Male RJ45, field-wireable, IDC terminals straight, IP20, 4-pole, shielded	Ethernet CAT5 Sealing range (cable Ø): 4.5...9 mm	7000-74001-0000000
	straight, IP20, 8-pole, shielded	Ethernet CAT6A Sealing range (cable Ø): 4.5...9 mm	7000-74011-0000000
	straight, IP20, 8-pole, shielded	PROFINET Ethernet CAT5 Sealing range (cable Ø): 5...9 mm	7000-74071-0000000
	straight, IP20, 8-pole, shielded	Ethernet CAT5 Sealing range (cable Ø): 5...9 mm	7000-74075-0000000
	Male RJ45, field-wireable, IDC terminals 45°, IP20, 4-pole, shielded	Ethernet CAT5e Sealing range (cable Ø): 4.5...8 mm	7000-74021-0000000
	45°, IP20, 8-pole, shielded	Ethernet CAT6A Sealing range (cable Ø): 4.5...8 mm	7000-74031-0000000
	Male RJ45, field-wireable, IDC terminals 90°, IP20, 8-pole, shielded on top	Ethernet CAT5 PROFINET Sealing range (cable Ø): 5...9 mm	7000-74081-0000000
	90°, IP20, 8-pole, shielded on top	Ethernet CAT5 Sealing range (cable Ø): 5...9 mm	7000-74085-0000000
	90°, IP20, 8-pole, shielded on bottom	Ethernet CAT5 PROFINET Sealing range (cable Ø): 5...9 mm	7000-74091-0000000
	90°, IP20, 8-pole, shielded on bottom	Ethernet CAT5 Sealing range (cable Ø): 5...9 mm	7000-74095-0000000

Connection accessories			Art-No.
	Adapter M12/RJ45 (female/female) straight, D-coded, 4-pole, shielded	Ethernet CAT5	7000-44671-0000000
	Adapter M12/RJ45 (female/female) 90°, D-coded, 4-pole, shielded	Ethernet CAT5	7000-44681-0000000
	Adapter M12/RJ45 (female/female) straight, X-coded, 8-pole, shielded	Ethernet CAT6A	7000-51531-0000000
	Adapter M12/RJ45 (female/female) 90°, X-coded, 8-pole, shielded	Ethernet CAT6A	7000-51541-0000000
	Terminator M12 (male) straight, A-coded, 5-pole	DeviceNet, CANopen	7000-13461-0000000
	straight, B-coded, 4-pole	PROFIBUS	7000-14041-0000000
	straight, A-coded, 6-pole	Cube67	7000-15041-0000000
	Terminator 7/8" (male) straight, screw fixing, 5-pole	DeviceNet, CANopen	7000-78301-0000000
	Male M12, field-wireable, IDC terminals straight, X-coded, 8-pole, shielded	Ethernet CAT6A Sealing range (cable Ø): 5.5...9 mm	7000-21101-0000000
	M12 Flange female straight straight, X-coded, 8-pole, shielded Front mounting	Ethernet CAT6A	7000-21151-0000000
	straight, X-coded, 8-pole, shielded Rear mounting	Ethernet CAT6A	7000-21161-0000000
	M12 Flange female straight straight, Y-coded, 8-pole, shielded Front mounting	Ethernet CAT5	7000-15701-0000000

FIELDBUS CONNECTORS

Connection accessories			Art-No.
	M12 Flange female 90° 90°, Y-coded, 8-pole, shielded Front mounting	Ethernet CAT5	7000-15711-000000
	Control cabinet entry system M12 straight, A-coded, 5-pole, shielded straight, B-coded, 5-pole, shielded straight, A-coded, 6-pole, shielded	DeviceNet, CANopen PROFIBUS, Interbus Cube67	7000-42111-000000 7000-44111-000000 7000-46111-000000
	Control cabinet entry system M12 straight, D-coded, 4-pole, shielded (female/female)	Ethernet CAT5	7000-44611-000000
	Flange M12 male, pre-wired 0.2 m straight, B-coded, 5-pole straight, A-coded, 5-pole	PROFIBUS, Interbus DeviceNet, CANopen	7000-14121-9750020 7000-13521-9720020
	Flange M12 female, pre-wired 0.2 m straight, B-coded, 5-pole straight, A-coded, 5-pole	PROFIBUS, Interbus DeviceNet, CANopen	7000-14161-9750020 7000-13561-9720020
	Flange M12 female, CAT 5, pre-wired 0.2 m straight, D-coded, 4-pole, shielded	Ethernet CAT5	7000-14501-9760020
	Push Pull Power connector, spring clamp terminals straight, IP65/67, 5-pole	Sealing range (cable Ø): 9...13 mm	7000-99601-000000
	Push Pull RJ45 data connector, IDC terminals straight, IP65/67, 8-pole	Ethernet CAT5 Sealing range (cable Ø): 5.5...10 mm	7000-99591-000000
	Push Pull RJ45 data connector, IDC terminals straight, IP65/67, 4-pole	PROFINET IO Sealing range (cable Ø): 4...11 mm	7000-74041-000000

Connection accessories			Art-No.
	<p>Push Pull RJ45 data connector, IDC terminals 45°, IP65/67, 4-pole</p>	<p>PROFINET IO Sealing range (cable Ø): 6.5...9.5 mm</p>	<p>7000-74061-0000000</p>
	<p>Push Pull SCRJ POF male, field-wireable straight, IP65/67, for POF 1 mm</p>	<p>PROFINET IO Sealing range (cable Ø): 6.5...9.5 mm</p>	<p>7000-99701-0000000</p>
	<p>Push Pull SCRJ POF male, field-wireable straight, IP65/67, for POF 1 mm Connection Crimp</p>	<p>PROFINET IO Sealing range (cable Ø): 6.5...9.5 mm</p>	<p>7000-99691-0000000</p>
	<p>Push Pull SCRJ POF male, field-wireable straight Connection Crimp</p>		<p>7000-99695-0000000</p>
	<p>Protective cover Push Pull Power</p>		<p>7000-99661-0000000</p>
	<p>Protective cover Push Pull RJ45</p>		<p>7000-99671-0000000</p>
	<p>Cable drum (100 m) 1 × 2 × 0.64 mm², violet suitable for C-tracks</p>	<p>PROFIBUS</p>	<p>7000-C0201-8400000</p>
	<p>Cable drum (100 m) 2 × 0.25 + 2 × 0.34 mm², violet suitable for C-tracks</p>	<p>DeviceNet, CANopen</p>	<p>7000-C0201-8030000</p>

FIELDBUS CONNECTORS

Connection accessories			Art-No.
	Cable drum (100 m) 2 × 2 × 0.34 mm ² , green suitable for C-tracks	Ethernet CAT5, PROFINET IO, EtherCAT	7000-C0201-7960000
	Cable drum (100 m) 2 × 2 × 0.34 mm ² , violet suitable for C-tracks	Ethernet CAT5, PROFINET IO, EtherCAT	7000-C0201-7980000
	Cable drum (100 m) 2 × 1.5 mm ² , gray suitable for C-tracks	AS-Interface, MASI68	7000-C0201-5880000
	Cable drum (100 m) 4 × 0.75 mm ² , gray suitable for C-tracks	AS-Interface, MASI68	7000-C0201-8620000
	Bus Connection Plug 90° SUB-D9 (female), screw terminals SUB-D9 (male), screw terminals	CANopen PROFIBUS	55760 55762
	Bus Connection Plug 180° SUB-D9 (male), IDC terminals, rigid cable	PROFIBUS	55584
	Bus Connection Plug 90° SUB-D9 (male), IDC terminals, rigid cable	PROFIBUS	55585

Fieldbus Connectors

Connection accessories			Art-No.
	<p>Bus Connection Plug 90° SUB-D9 (male), IDC terminals, rigid cable, programming device conn.</p>	<p>PROFIBUS</p>	<p>55586</p>
	<p>Bus Connection Plug 90° SUB-D9 (male); M12 × 1, B-coded</p>	<p>PROFIBUS</p>	<p>7000-99441-0000000</p>
	<p>Bus Connection Plug 35° SUB-D9 (male); M12 × 1, B-coded</p>	<p>PROFIBUS</p>	<p>7000-99401-0000000</p>
	<p>Bus Connection Plug 90° SUB-D9 (male); M12 × 1, B-coded</p>	<p>PROFIBUS</p>	<p>7000-99411-0000000</p>
	<p>Bus Connection Plug 180° SUB-D9 (male); M12 × 1, B-coded</p>	<p>PROFIBUS</p>	<p>7000-99421-0000000</p>
	<p>Bus Connection Plug 90° SUB-D9 (male); M12 × 1, B-coded Zinc die casting</p>	<p>PROFIBUS</p>	<p>7000-99431-0000000</p>
Labeling accessories			Art-No.
	<p>Slip-on cable sleeve for ACS label plates (4 × 18 mm)</p>	<p>Cable diameter (4...6.5 mm)</p>	<p>7000-99004-0000000</p>

FIELDBUS CONNECTORS

Labeling accessories			Art-No.
	Snap-on cable sleeve for ACS label plates (4 × 18 mm)	Cable diameter (4.2...5.6 mm)	7000-99005-0000000
	for ACS label plates (4 × 18 mm)	Cable diameter (5...7 mm)	7000-99006-0000000
	ACS label plate for self marking (4 × 18 mm)		7000-99002-0000000
Mounting accessories			Art-No.
	Torque wrench set M8 (0.4 Nm, SW9)	M8 data connectors	7000-99101-0000000
	Torque wrench set M12 (0.6 Nm, SW13)	M12 data connector molded (standard)	7000-99102-0000000
End fitting accessories			Art-No.
	Tube adapter snap-in for corrugated tube (size 13mm)	Cable diameter (4...7 mm)	7000-99081-0000000



CONNECTORS FOR FOOD & BEVERAGE

- Made with stainless steel
- Resistant to cleaning substances
- High protection degree

MEETS DEMANDING HYGIENIC STANDARDS

The food and beverage industry needs an extremely clean environment – perfect hygiene is required. Products and components have to be highly resistant and handle tough environments. Murrelektronik offers a wide connector range for this industry and each product meets the tough requirements. All metal parts are made of stainless steel and the cables feature a PVC or TPE-S jacket.

Murrelektronik is closely connected to this industry and can fulfill all the important requirements of the food and beverage industry. And Murrelektronik offers even more:

- Complete system solutions
- Comprehensive diagnostic options
- Vibration-proof products
- Excellent logistics for fast deliveries
- Specialists with industry-specific knowledge

ECOLAB[®]



STAINLESS STEEL

With Open Ended Wires

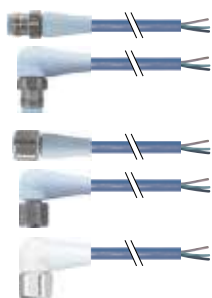

M12 F&B Pro male

- Straight
- 90°

M12 F&B Pro female

- Straight
- 90°
- 90° with LED

Page 3.7.1

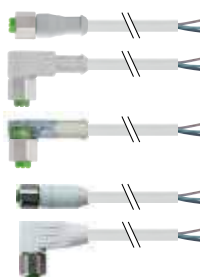

M12 F&B female

- Straight
- 90°
- 90° with LED
- Straight (shielded)
- 90° (shielded)

Page 3.7.10

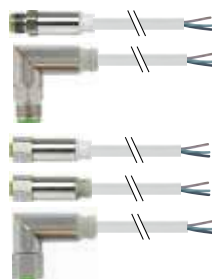

M12 Steel male

- Straight
- 90°

M12 Steel female

- Straight
- Straight with LED
- 90°

Page 3.7.15

Connection Cables



M12 F&B Pro male
• Straight
• 90°

M12 F&B Pro female
• Straight
• 90°

Page 3.7.19



M12 F&B male
• Straight

M12 F&B female
• Straight
• 90°
• 90° with LED

Page 3.7.14



M12 Steel male
• Straight
• 90°

M12 Steel female
• Straight
• Straight with LED
• 90°

Page 3.7.16

PLUG CONNECTORS FOR FOOD & BEVERAGE

M12 F&B Pro

- with open ended wires M12
- high resistance PP materials
- Screw, Stainless Steel 1.4404 (V4A)

Approvals: **ECOLAB**

Male
straight



Male
90°



1 Form	12001	12081
Type	3-pole	3-pole
Circuit diagram		
Contact layout	<p>Male</p>	
2 Cable Type	Jacket Color	Jacket Color
Wire diameter 0.34 mm ² TPE-S (UL) robots/C-tracks	pastel blue 315	pastel blue 315
3 Cable Length		
1.5 m	0150	
3.0 m	0300	
5.0 m	0500	
7.5 m	0750	
10.0 m	1000	
Technical Data		
Operating voltage	max. 250 V AC/DC	
Protection	IP65/IP68/IP69K inserted and tightened (EN 60529)	
Temperature range	-40...+105 °C, depending on cable quality	
Article No.		
The composition of your article number is explained on page 3.1.i	<p>7 0 2 4 - - - - - - - - - -</p>	
	1 Form	2 Cable Type
		3 Cable Length
Notes	Other versions on request. Further cable lengths on request.	

PLUG CONNECTORS FOR FOOD & BEVERAGE

M12 F&B Pro

- with open ended wires M12
- high resistance PP materials
- Screw, Stainless Steel 1.4404 (V4A)

Approvals: **ECOLAB**

Male

straight



Male

90°



1 Form	12021	12101
	Type 4-pole	Type 4-pole
Circuit diagram		
Contact layout		
2 Cable Type	Jacket Color	Jacket Color
Wire diameter 0.34 mm ² TPE-S (UL) robots/C-tracks	pastel blue 321	pastel blue 321
3 Cable Length		
1.5 m	0150	
3.0 m	0300	
5.0 m	0500	
7.5 m	0750	
10.0 m	1000	
Technical Data		
Operating voltage	max. 250 V AC/DC	
Protection	IP65/IP68/IP69K inserted and tightened (EN 60529)	
Temperature range	-40...+105 °C, depending on cable quality	
Article No.		
The composition of your article number is explained on page 3.1.i	<div style="display: flex; justify-content: space-around; align-items: center;"> 7 0 2 4 - - </div>	
	1 Form	2 Cable Type
		3 Cable Length
Notes	Other versions on request. Further cable lengths on request.	

Plug Connectors for Food & Beverage

PLUG CONNECTORS FOR FOOD & BEVERAGE

M12 F&B Pro

- with open ended wires M12
- high resistance PP materials
- Screw, Stainless Steel 1.4404 (V4A)

Approvals: **ECOLAB**

Male
straight



Male
90°



1 Form	12041	12121
Type	5-pole	5-pole
Circuit diagram		
Contact layout	<p>Male</p>	
2 Cable Type	Jacket Color	Jacket Color
Wire diameter 0.34 mm ² TPE-S (UL) robots/C-tracks	pastel blue 339	pastel blue 339
3 Cable Length		
1.5 m	0150	
3.0 m	0300	
5.0 m	0500	
7.5 m	0750	
10.0 m	1000	
Technical Data		
Operating voltage	max. 125 V AC/DC	
Protection	IP65/IP68/IP69K inserted and tightened (EN 60529)	
Temperature range	-40...+105 °C, depending on cable quality	
Article No.		
The composition of your article number is explained on page 3.1.i	<p>7 0 2 4 - - - - - - - - - -</p>	
	1 Form	2 Cable Type
		3 Cable Length
Notes	Other versions on request. Further cable lengths on request.	

PLUG CONNECTORS FOR FOOD & BEVERAGE

M12 F&B Pro

- with open ended wires M12
- high resistance PP materials
- Screw, Stainless Steel 1.4404 (V4A)

Approvals: **ECOLAB**

Female
straight



Female
90°



1 Form	12181	12321	
	Type 3-pole	Type 3-pole	
Circuit diagram			
Contact layout	<p>Female</p>		
2 Cable Type	Jacket Color	Jacket Color	
	Wire diameter 0.34 mm ² TPE-S (UL) robots/C-tracks	pastel blue 315	pastel blue 315
3 Cable Length	1.5 m	0150	
	3.0 m	0300	
	5.0 m	0500	
	7.5 m	0750	
	10.0 m	1000	
	Technical Data		
Operating voltage	max. 250 V AC/DC		
Protection	IP65/IP68/IP69K inserted and tightened (EN 60529)		
Temperature range	-40...+105 °C, depending on cable quality		
Article No.			
The composition of your article number is explained on page 3.1.i	<div style="display: flex; justify-content: space-around; align-items: center;"> 7 0 2 4 - - </div>		
	1 Form	2 Cable Type	3 Cable Length
Notes	Other versions on request. Further cable lengths on request.		

PLUG CONNECTORS FOR FOOD & BEVERAGE

M12 F&B Pro

- with open ended wires M12
- high resistance PP materials
- Screw, Stainless Steel 1.4404 (V4A)

Approvals: **ECOLAB**

Female
straight



Female
90°



1 Form	12221	12341
Type	4-pole	4-pole
Circuit diagram		
Contact layout	<p>Female</p>	
2 Cable Type	Jacket Color	Jacket Color
Wire diameter 0.34 mm ² TPE-S (UL) robots/C-tracks	pastel blue 321	pastel blue 321
3 Cable Length		
1.5 m	0150	
3.0 m	0300	
5.0 m	0500	
7.5 m	0750	
10.0 m	1000	
Technical Data		
Operating voltage	max. 250 V AC/DC	
Protection	IP65/IP68/IP69K inserted and tightened (EN 60529)	
Temperature range	-40...+105 °C, depending on cable quality	
Article No.		
The composition of your article number is explained on page 3.1.i	<p>7 0 2 4 - - - - - - - - - -</p>	
	1 Form	2 Cable Type
		3 Cable Length
Notes	Other versions on request. Further cable lengths on request.	

PLUG CONNECTORS FOR FOOD & BEVERAGE

M12 F&B Pro

- with open ended wires M12
- high resistance PP materials
- Screw, Stainless Steel 1.4404 (V4A)

Approvals: **ECOLAB**

Female
straight



Female
90°



1 Form	12241	12361	
	Type 5-pole	5-pole	
Circuit diagram			
Contact layout	Female 		
2 Cable Type	Jacket Color	Jacket Color	
	Wire diameter 0.34 mm ² TPE-S (UL) robots/C-tracks	pastel blue 339	pastel blue 339
3 Cable Length	1.5 m	0150	
	3.0 m	0300	
	5.0 m	0500	
	7.5 m	0750	
	10.0 m	1000	
	Technical Data		
Operating voltage	max. 125 V AC/DC		
Protection	IP65/IP68/IP69K inserted and tightened (EN 60529)		
Temperature range	-40...+105 °C, depending on cable quality		
Article No.			
The composition of your article number is explained on page 3.1.i	7 0 2 4 - - - - - - - - - -		
	1 Form	2 Cable Type	3 Cable Length
Notes	Other versions on request. Further cable lengths on request.		

PLUG CONNECTORS FOR FOOD & BEVERAGE

M12 F&B Pro

- with open ended wires M12
- high resistance PP materials
- Screw, Stainless Steel 1.4404 (V4A)

Approvals: **ECOLAB**

Female
90° with LED

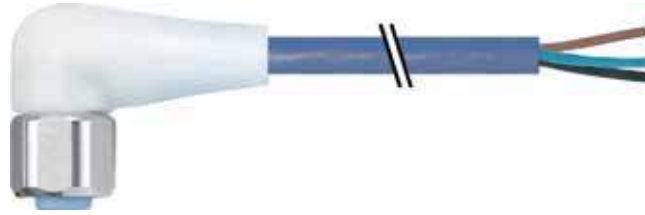

1 Form		12441	
Type	5-pole with 3 × LED (PNP) (NPN) on request		
Circuit diagram			
Contact layout	<p>Female</p>		
2 Cable Type		Jacket Color	
Wire diameter 0.34 mm ² TPE-S (UL) robots/C-tracks	<p>pastel blue 339</p>		
3 Cable Length			
1.5 m	0150		
3.0 m	0300		
5.0 m	0500		
7.5 m	0750		
10.0 m	1000		
Technical Data			
Operating voltage	24 V DC ±25%		
Protection	IP65/IP68/IP69K inserted and tightened (EN 60529)		
Temperature range	-40...+85 °C, depending on cable quality		
Article No.			
The composition of your article number is explained on page 3.1.i	<p>7 0 2 4 - 1 2 4 4 1 - _ _ _ _</p>		
	1 Form	2 Cable Type	3 Cable Length
Notes			
Other versions on request. Further cable lengths on request.			

PLUG CONNECTORS FOR FOOD & BEVERAGE

M12 F&B Pro

- Connection cables M12 - M12
- high resistance PP materials
- Screw, Stainless Steel 1.4404 (V4A)

Approvals: **ECOLAB**

Male

straight

Female

straight



1 Form	40001	40021
Type	3-pole	4-pole
Circuit diagram		
Contact layout		
2 Cable Type	Jacket Color	Jacket Color
Wire diameter 0.34 mm ² TPE-S (UL) robots/C-tracks	pastel blue 315	pastel blue 321
3 Cable Length		
0.3 m	0030	
0.6 m	0060	
1.0 m	0100	
1.5 m	0150	
2.0 m	0200	
Technical Data		
Operating voltage	max. 250 V AC/DC	
Protection	IP65/IP68/IP69K inserted and tightened (EN 60529)	
Temperature range	-40...+105 °C, depending on cable quality	
Article No.		
The composition of your article number is explained on page 3.1.i	<div style="display: flex; justify-content: space-around; align-items: center;"> 7 0 2 4 - - </div>	
	1 Form	2 Cable Type
		3 Cable Length
Notes	Other versions on request. Further cable lengths on request.	

Plug Connectors for Food & Beverage

PLUG CONNECTORS FOR FOOD & BEVERAGE

M12 F&B Pro

- Connection cables M12 - M12
- high resistance PP materials
- Screw, Stainless Steel 1.4404 (V4A)

Approvals: **ECOLAB**

Male
straight

Female
straight

Male
90°

Female
90°



1 Form	40041	40281
Type	5-pole	5-pole
Circuit diagram		
Contact layout		
2 Cable Type	Jacket Color	Jacket Color
Wire diameter 0.34 mm ² TPE-S (UL) robots/C-tracks	pastel blue 339	pastel blue 339
3 Cable Length		
0.3 m	0030	
0.6 m	0060	
1.0 m	0100	
1.5 m	0150	
2.0 m	0200	
Technical Data		
Operating voltage	max. 125 V AC/DC	
Protection	IP65/IP68/IP69K inserted and tightened (EN 60529)	
Temperature range	-40...+105 °C, depending on cable quality	
Article No.		
The composition of your article number is explained on page 3.1.i	7 0 2 4 - - - - - - - - - -	
	1 Form	2 Cable Type
		3 Cable Length
Notes	Other versions on request. Further cable lengths on request.	

PLUG CONNECTORS FOR FOOD & BEVERAGE

with open ended wires M12

– Stainless Steel 1.4404 (V4A)

– Profile gasket



Approvals:   
 * only for products with UL/CSA approved cable

Female
straight



Female
90°

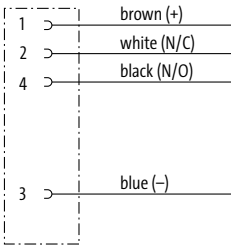

1 Form	12221	12341								
	Type 4-pole	Type 4-pole								
Circuit diagram										
Contact layout	<p>Female</p> 									
2 Cable Type	Jacket Color	Jacket Color								
Wire diameter 0.34 mm ² PVC (UL/CSA)	gray 214	gray 214								
3 Cable Length										
1.5 m	0150									
3.0 m	0300									
5.0 m	0500									
7.5 m	0750									
10.0 m	1000									
Technical Data										
Operating voltage	max. 250 V AC/DC									
Protection	IP65, IP68 inserted and tightened (EN 60529)									
Temperature range	-25...+85 °C, depending on cable quality									
Article No.										
The composition of your article number is explained on page 3.1.i	<table border="1"> <tr> <td><u>7</u></td> <td><u>0</u></td> <td><u>1</u></td> <td><u>4</u></td> <td>-</td> <td>-</td> <td>-</td> <td>-</td> </tr> </table>		<u>7</u>	<u>0</u>	<u>1</u>	<u>4</u>	-	-	-	-
<u>7</u>	<u>0</u>	<u>1</u>	<u>4</u>	-	-	-	-			
	1 Form	2 Cable Type	3 Cable Length							
Notes	Other versions on request. Further cable lengths on request.									

Plug Connectors for Food & Beverage

PLUG CONNECTORS FOR FOOD & BEVERAGE

with open ended wires M12

– Stainless Steel 1.4404 (V4A)

– Profile gasket

Approvals:   
* only for products with UL/CSA approved cable

Female
90° with LED

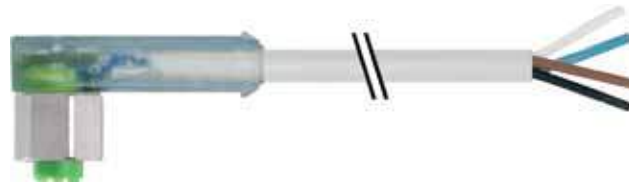

1 Form		12421	
Type	4-pole with 3 × LED (PNP) (NPN) on request		
Circuit diagram			
Contact layout	Female 		
2 Cable Type		Jacket Color	
Wire diameter 0.34 mm ² PVC (UL/CSA)	gray 214		
3 Cable Length			
1.5 m	0150		
3.0 m	0300		
5.0 m	0500		
7.5 m	0750		
10.0 m	1000		
Technical Data			
Operating voltage	24 V DC ±25%		
Protection	IP65, IP68 inserted and tightened (EN 60529)		
Temperature range	-25...+85 °C, depending on cable quality		
Article No.			
The composition of your article number is explained on page 3.1.i	7 0 1 4 - 1 2 4 2 1 - - - - -		
	1 Form	2 Cable Type	3 Cable Length
Notes	Other versions on request. Further cable lengths on request.		

PLUG CONNECTORS FOR FOOD & BEVERAGE

with open ended wires M12

– Stainless Steel 1.4404 (V4A)

– Profile gasket



Approvals:   
 * only for products with UL/CSA approved cable

Female
straight



Female
90°

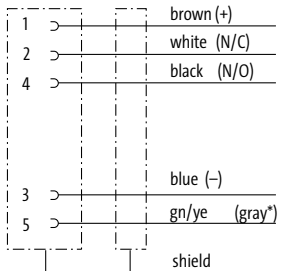

1 Form		13221		13281	
Type	5-pole, shielded			5-pole, shielded	
Circuit diagram	 <p>(* for cable type 203)</p>				
Contact layout	<p>Female</p> 				
2 Cable Type		Jacket Color		Jacket Color	
Wire diameter 0.34 mm ² PVC (UL/CSA)		gray 202 (203)	black 602 (603)	gray 202 (203)	black 602 (603)
3 Cable Length					
1.5 m	0150				
3.0 m	0300				
5.0 m	0500				
7.5 m	0750				
10.0 m	1000				
Technical Data					
Operating voltage	max. 60 V AC/DC				
Protection	IP65, IP68 inserted and tightened (EN 60529)				
Temperature range	-25...+85 °C, depending on cable quality				
Article No.					
The composition of your article number is explained on page 3.1.i	<div style="display: flex; justify-content: space-around; align-items: center;"> 7 0 1 4 - - </div>				
	1	2	3		
	Form	Cable Type	Cable Length		
Notes		Other versions on request. Further cable lengths on request.			

Plug Connectors for Food & Beverage

PLUG CONNECTORS FOR FOOD & BEVERAGE

Connection cables M12 - M12

– Stainless Steel 1.4404 (V4A)

– Profile gasket

Male
straight

Female
straight

Male
straight

Female
90°



Approvals: **ECOLAB**
* only for products with UL/CSA approved cable

1 Form	4 0 0 2 1	4 0 1 2 1
Type	4-pole	4-pole
Circuit diagram		
Contact layout		
2 Cable Type	Jacket Color	Jacket Color
Wire diameter 0.34 mm ² PVC (UL/CSA)	gray 214	gray 214
3 Cable Length		
0.3 m	0030	
0.6 m	0060	
1.0 m	0100	
1.5 m	0150	
2.0 m	0200	
Technical Data		
Operating voltage	max. 250 V AC/DC	
Protection	IP65, IP68 inserted and tightened (EN 60529)	
Temperature range	-25...+85 °C, depending on cable quality	
Article No.		
The composition of your article number is explained on page 3.1.i	7 0 1 4 - - - - - - - - - -	
	1 Form	2 Cable Type
		3 Cable Length
Notes	Other versions on request. Further cable lengths on request.	

PLUG CONNECTORS FOR FOOD & BEVERAGE

Connection cables M12 - M12

- Stainless Steel 1.4404 (V4A)
- Profile gasket

Approvals:   
 * only for products with UL/CSA approved cable

Male

straight

Female

90° with LED



1 Form	40341	
	Type	4-pole with 3 x LED (PNP) (NPN) on request
Circuit diagram		
Contact layout		
2 Cable Type	Jacket Color	
Wire diameter 0.34 mm ² PVC (UL/CSA)	gray 214	
3 Cable Length		
0.3 m	0030	
0.6 m	0060	
1.0 m	0100	
1.5 m	0150	
2.0 m	0200	
Technical Data		
Operating voltage	24 V DC ±25%	
Protection	IP65, IP68 inserted and tightened (EN 60529)	
Temperature range	-25...+85 °C, depending on cable quality	
Article No.		
The composition of your article number is explained on page 3.1.i	<u>7</u> <u>0</u> <u>1</u> <u>4</u> - <u>4</u> <u>0</u> <u>3</u> <u>4</u> <u>1</u> - _ _ _	_ _ _ _
	1 Form	2 Cable Type
		3 Cable Length
Notes	Other versions on request. Further cable lengths on request.	

PLUG CONNECTORS FOR FOOD & BEVERAGE

With open ended wires

- M12-Steel
- Stainless Steel 1.4404 (V4A)
- Permanently IP69K

Approvals:  

* only for products with UL/CSA approved cable

Male

straight



Male

90°

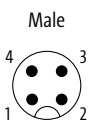

1 Form	12021	12101
Type	4-pole	4-pole
Circuit diagram		
Contact layout		
2 Cable Type	Jacket Color	Jacket Color
Wire diameter 0.34 mm ²	gray	gray
PVC (UL/CSA)	214	214
TPE-S	336	336
3 Cable Length		
1.5 m	0150	
3.0 m	0300	
5.0 m	0500	
7.5 m	0750	
10.0 m	1000	
Technical Data		
Operating voltage	max. 32 V AC/DC	
Protection	IP68, IP69K inserted and tightened (EN 60529)	
Temperature range	-40...+85 °C, depending on cable quality	
Article No.		
The composition of your article number is explained on page 3.1.i	<div style="display: flex; justify-content: space-around; align-items: center;"> 7 0 4 4 - - </div>	
	1 Form	2 Cable Type
		3 Cable Length
Notes	Other versions on request. Further cable lengths on request.	

PLUG CONNECTORS FOR FOOD & BEVERAGE

With open ended wires

- M12-Steel
- Stainless Steel 1.4404 (V4A)
- Permanently IP69K

Approvals: **ECOLAB** **CSF** **US**

* only for products with UL/CSA approved cable

Female
straight



1 Form	12221	12241
Type	4-pole	5-pole
Circuit diagram		<p>(* for cable type 219)</p>
Contact layout	<p>Female</p>	<p>Female</p>
2 Cable Type	Jacket Color	Jacket Color
Wire diameter 0.34 mm ²	gray	gray black
PVC (UL/CSA)	214	215 615
TPE-S	336	
3 Cable Length		
1.5 m	0150	
3.0 m	0300	
5.0 m	0500	
7.5 m	0750	
10.0 m	1000	
Technical Data		
Operating voltage	max. 32 V AC/DC	
Protection	IP68, IP69K inserted and tightened (EN 60529)	
Temperature range	-40...+85 °C, depending on cable quality	
Article No.		
The composition of your article number is explained on page 3.1.i	<p>7 0 4 4 - - - - -</p>	
	1 Form	2 Cable Type 3 Cable Length
Notes	Other versions on request. Further cable lengths on request.	

Plug Connectors for Food & Beverage

PLUG CONNECTORS FOR FOOD & BEVERAGE

With open ended wires

- M12-Steel
- Stainless Steel 1.4404 (V4A)
- Permanently IP69K

Approvals: 

* only for products with UL/CSA approved cable

Female

90°

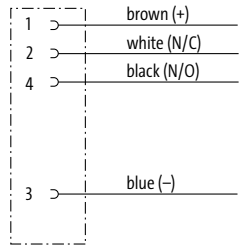
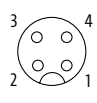

1 Form		12341	
Type	4-pole		
Circuit diagram			
Contact layout	<p>Female</p> 		
2 Cable Type		Jacket Color	
Wire diameter 0.34 mm ²		gray	
PVC (UL/CSA)		214	
TPE-S		336	
3 Cable Length			
1.5 m	0150		
3.0 m	0300		
5.0 m	0500		
7.5 m	0750		
10.0 m	1000		
Technical Data			
Operating voltage	max. 32 V AC/DC		
Protection	IP68, IP69K inserted and tightened (EN 60529)		
Temperature range	-40...+85 °C, depending on cable quality		
Article No.			
The composition of your article number is explained on page 3.1.i	<p>7 0 4 4 - 1 2 3 4 1 - - -</p>		
	1 Form	2 Cable Type	3 Cable Length
Notes			
Other versions on request. Further cable lengths on request.			

PLUG CONNECTORS FOR FOOD & BEVERAGE

With open ended wires



- M12-Steel
- Stainless Steel 1.4404 (V4A)
- Permanently IP69K

Approvals: 

* only for products with UL/CSA approved cable

Female
straight, with LED

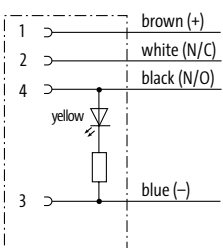

1 Form		12292	
Type	4-pole with 1 × LED (PNP) (NPN) on request		
Circuit diagram			
Contact layout	Female 		
2 Cable Type		Jacket Color	
Wire diameter 0.34 mm ²		gray	
PVC (UL/CSA)		214	
TPE-S		336	
3 Cable Length			
1.5 m		0150	
3.0 m		0300	
5.0 m		0500	
7.5 m		0750	
10.0 m		1000	
Technical Data			
Operating voltage	24 V AC/DC ±25%		
Protection	IP68, IP69K inserted and tightened (EN 60529)		
Temperature range	-40...+85 °C, depending on cable quality		
Article No.			
The composition of your article number is explained on page 3.1.i	7 0 4 4 - 1 2 2 9 2 - - - - -		
	1 Form	2 Cable Type	3 Cable Length
Notes		Other versions on request. Further cable lengths on request.	

Plug Connectors for Food & Beverage

PLUG CONNECTORS FOR FOOD & BEVERAGE

Connection cables

- M12-Steel
- Stainless Steel 1.4404 (V4A)
- Permanently IP69K

Approvals:  

* only for products with UL/CSA approved cable

Male
straight

Female
straight

Male
straight

Female
90°



1 Form	40021	40121
Type	4-pole	4-pole
Circuit diagram		
Contact layout		
2 Cable Type	Jacket Color	Jacket Color
Wire diameter 0.34 mm ²	gray	gray
PVC (UL/CSA)	214	214
TPE-S	336	336
3 Cable Length		
0.3 m	0030	
0.6 m	0060	
1.0 m	0100	
1.5 m	0150	
2.0 m	0200	
Technical Data		
Operating voltage	max. 32 V AC/DC	
Protection	IP68, IP69K inserted and tightened (EN 60529)	
Temperature range	-40...+85 °C, depending on cable quality	
Article No.		
The composition of your article number is explained on page 3.1.i	<p>7 0 4 4 - - - - - - - - - -</p>	
	1 Form	2 Cable Type
		3 Cable Length
Notes	Other versions on request. Further cable lengths on request.	

PLUG CONNECTORS FOR FOOD & BEVERAGE

Connection cables

- M12-Steel
- Stainless Steel 1.4404 (V4A)
- Permanently IP69K

Approvals: 

* only for products with UL/CSA approved cable

Male
90°

Female
straight



Male
90°

Female
90°

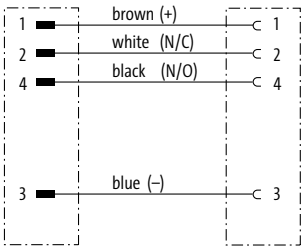
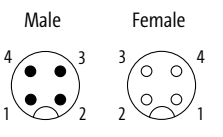

1 Form	40201	40261	
	Type 4-pole	Type 4-pole	
Circuit diagram			
	Contact layout		
2 Cable Type	Jacket Color	Jacket Color	
	Wire diameter 0.34 mm ²	gray	gray
	PVC (UL/CSA)	214	214
TPE-S	336	336	
3 Cable Length	0.3 m	0030	
	0.6 m	0060	
	1.0 m	0100	
	1.5 m	0150	
	2.0 m	0200	
	Technical Data		
Operating voltage	max. 32 V AC/DC		
Protection	IP68, IP69K inserted and tightened (EN 60529)		
Temperature range	-40...+85 °C, depending on cable quality		
Article No.			
The composition of your article number is explained on page 3.1.i	<div style="display: flex; justify-content: space-around; align-items: center;"> 7 0 4 4 - - </div>		
	1 Form	2 Cable Type	3 Cable Length
Notes	Other versions on request. Further cable lengths on request.		

Plug Connectors for Food & Beverage

PLUG CONNECTORS FOR FOOD & BEVERAGE

Connection cables

- M12-Steel
- Stainless Steel 1.4404 (V4A)
- Permanently IP69K

Approvals:  

* only for products with UL/CSA approved cable

Male

straight

Female

straight, with LED

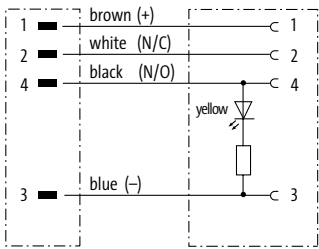
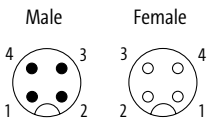

1 Form		4 0 3 1 2	
Type	4-pole with 1 × LED (PNP) (NPN) on request		
Circuit diagram			
Contact layout			
2 Cable Type		Jacket Color	
Wire diameter 0.34 mm ²		gray	
PVC (UL/CSA)		214	
TPE-S		336	
3 Cable Length			
0.3 m		0030	
0.6 m		0060	
1.0 m		0100	
1.5 m		0150	
2.0 m		0200	
Technical Data			
Operating voltage	24 V AC/DC ±25%		
Protection	IP68, IP69K inserted and tightened (EN 60529)		
Temperature range	-40...+85 °C, depending on cable quality		
Article No.			
The composition of your article number is explained on page 3.1.i		<u>7 0 4 4</u> - <u>4 0 3 1 2</u> - ____ - ____	
		1 Form	2 Cable Type
			3 Cable Length
Notes		Other versions on request. Further cable lengths on request.	

PLUG CONNECTORS FOR FOOD & BEVERAGE

Labeling accessories			Art-No.
	Slip-on cable sleeve for ACS label plates (4 × 18 mm)	Cable diameter (4...6.5 mm)	7000-99004-000000
	Snap-on cable sleeve for ACS label plates (4 × 18 mm)	Cable diameter (4.2...5.6 mm)	7000-99005-000000
	for ACS label plates (4 × 18 mm)	Cable diameter (5...7 mm)	7000-99006-000000
	ACS label plate for self marking (4 × 18 mm)		7000-99002-000000
	Colored ring M8/M12 sandy yellow	for unshielded molding	7000-99301-V011002
	zinc yellow	for unshielded molding	7000-99301-V011018
	redorange	for unshielded molding	7000-99301-V012008
	red	for unshielded molding	7000-99301-V013020
	violet	for unshielded molding	7000-99301-V014003
	purple	for unshielded molding	7000-99301-V014006
	blue	for unshielded molding	7000-99301-V015005
	green	for unshielded molding	7000-99301-V016018
	gray	for unshielded molding	7000-99301-V017035
	white	for unshielded molding	7000-99301-V019003
	black	for unshielded molding	7000-99301-V019004
Mounting accessories			Art-No.
	Torque wrench set M8 (0.4 Nm, SW9)	M8 data connectors	7000-99101-000000
	Torque wrench set M12 (0.6 Nm, SW13)	M12 data connector molded (standard)	7000-99102-000000
	Torque wrench set M12 (0.6 Nm, SW14)		7000-99107-000000
	Torque wrench M12 (0.6 Nm, SW14)	M12 data connector moulded (Xtreme)	7000-99108-000000
	Torque wrench M12 (0.6 Nm, SW17)	M12 field-wireable (IDC terminal)	7000-99094-000000
	Torque wrench M12 (0.6 Nm, SW18)	M12 field-wireable via (screw terminals)	7000-99103-000000

PLUG CONNECTORS FOR FOOD & BEVERAGE

Mounting accessories			Art-No.
	Hold clip M12 Plastic		7000-99045-0000000
End fitting accessories			Art-No.
	Tube adapter snap-in for corrugated tube (size 13mm)	Cable diameter (4...7 mm)	7000-99081-0000000
Connection accessories			Art-No.
	Universal holder modular	M8 M12	7000-99801-0000000
	Universal holder modular	M12 Y-connector M12	7000-99811-0000000



MOBILE APPLICATIONS FOR ROUGH APPLICATIONS

- Robust
- Resistant
- Sealed

KEEP YOUR MOBILE EQUIPMENT GOING STRONG WITH OUR FULLY POTTED CONNECTORS

Many leading mobile hydraulic valve manufacturers are currently updating their connection concepts. Instead of the old-fashioned (rectangular) valve connectors compliant with DIN EN 175301-803, they are increasingly recommending alternatives with Junior Power Timer, Deutsch or SuperSeal connectors.

MDC – MURRELEKTRONIK DEUTSCH CONNECTOR

Murrelektronik MDC connectors are pre-wired valve connectors, which are 100% compatible with Deutsch DT connectors. Even though the cables are connected to the housing and fully sealed, the connector is as compact as possible.

MSC – MURRELEKTRONIK SUPERSEAL CONNECTOR

Murrelektronik MSC cordsets are pre-wired valve connectors that are 100% compatible with the size 1.5 SuperSeal connectors. Even though the cables are connected to the housing and fully sealed, the connector is as compact as possible.

With Open Ended Wires



AMP Junior Power Timer

- Female straight
- Female 90°

Page 3.8.1



Deutsch MDC

- Male straight
- Y connector male
- Female straight

Page 3.8.3



SuperSeal MSC1.5

- Male straight
- Female straight

Page 3.8.8

MOBILE APPLICATIONS

Xtreme - Mobile Applications

- with open ended wires
- compatible with:
- AMP Junior Power Timer

Female
straight



1 Form	70001	70021	70061
Type	max. 230 V AC/DC without components	12...24 V AC/DC LED	12...24 V AC/DC LED and VDR
Circuit diagram			
Contact layout			
2 Cable Type	Jacket Color	Jacket Color	Jacket Color
Wire diameter 0.75 mm ²	black	black	black
PUR/PVC	750	750	750
PUR (UL/CSA), robots/C-tracks	754	754	754
Wire diameter 0.5 mm ²			
PUR, C-tracks	740	740	740
3 Cable Length			
1.5 m	0150		
3.0 m	0300		
5.0 m	0500		
7.5 m	0750		
10.0 m	1000		
Technical Data			
Operating voltage	max. 230 V AC/DC	12...24 V AC/DC	
Protection	IP65 inserted and tightened		
Temperature range	-25...+85 °C, depending on cable quality		
Article No.			
The composition of your article number is explained on page 3.1.i	<div style="display: flex; justify-content: space-around; align-items: center;"> 7 0 7 2 - - </div>		
	1	2	3
	Form	Cable Type	Cable Length
Notes	Other versions on request. Differing cable lengths up to 2 m can be ordered in 0.2 m steps, from 2 m on in 0.5 m steps.		

MOBILE APPLICATIONS

Xtreme - Mobile Applications

- with open ended wires
- compatible with:
- AMP Junior Power Timer

Female
90°



1 Form	70301	70321	70361
Type	max. 230 V AC/DC without components	12...24 V AC/DC LED	12...24 V AC/DC LED and VDR
Circuit diagram	<p>* for cable type (740)</p>	<p>* for cable type (740)</p>	<p>* for cable type (740)</p>
Contact layout			
2 Cable Type	Jacket Color	Jacket Color	Jacket Color
Wire diameter 0.75 mm ²	black	black	black
PUR/PVC	750	750	750
PUR (UL/CSA), robots/C-tracks	754	754	754
Wire diameter 0.5 mm ²			
PUR, C-tracks	740	740	740
3 Cable Length			
1.5 m	0150		
3.0 m	0300		
5.0 m	0500		
7.5 m	0750		
10.0 m	1000		
Technical Data			
Operating voltage	max. 230 V AC/DC	12...24 V AC/DC	
Protection	IP65 inserted and tightened		
Temperature range	-25...+85 °C, depending on cable quality		
Article No.			
The composition of your article number is explained on page 3.1.i	<div style="display: flex; justify-content: space-around; align-items: center;"> 7 0 7 2 - - </div>		
	1	2	3
	Form	Cable Type	Cable Length
Notes	Other versions on request. Differing cable lengths up to 2 m can be ordered in 0.2 m steps, from 2 m on in 0.5 m steps.		

MOBILE APPLICATIONS

Xtreme - Mobile Applications

- with open ended wires
- compatible with:
- Deutsch DT 06

Deutsch MDC 06-2S

Male straight



Deutsch MDC 06-3S

Male straight



1 Form	72011	72081									
	Type 2-pole 12...230 V AC/DC without components	Type 3-pole 6...230 V AC/DC without components									
Circuit diagram											
Contact layout	<p>Male female contacts</p>	<p>Male female contacts</p>									
2 Cable Type	Jacket Color	Jacket Color									
	Wire diameter 0.75 mm ² PUR/PVC PUR (UL/CSA), robots/Ctracks	<table border="1"> <tr> <td>black</td> <td>yellow</td> </tr> <tr> <td>750</td> <td></td> </tr> <tr> <td>754</td> <td>145</td> </tr> </table>	black	yellow	750		754	145	<table border="1"> <tr> <td>black</td> </tr> <tr> <td>564</td> </tr> </table>	black	564
	black	yellow									
750											
754	145										
black											
564											
3 Cable Length											
1.5 m	0150										
3.0 m	0300										
5.0 m	0500										
7.5 m	0750										
10.0 m	1000										
Technical Data											
Operating voltage	12...230 V AC/DC	6...230 V AC/DC									
Protection	IP68 inserted and tightened										
Temperature range	-25...+85 °C, depending on cable quality										
Article No.											
The composition of your article number is explained on page 3.1.i	<p>7 0 7 2 - - - - - - - - - -</p>										
	1 Form	2 Cable Type									
		3 Cable Length									
Notes	Other versions on request. Differing cable lengths up to 2 m can be ordered in 0.2 m steps, from 2 m on in 0.5 m steps.										

MOBILE APPLICATIONS

Xtreme - Mobile Applications

- with open ended wires
- compatible with:
- Deutsch DT 06

Deutsch MDC 06-4S

Male straight



Deutsch MDC 06-6S

Male straight



1 Form	72161	72221	
	<p>Type</p> <p>4-pole</p> <p>6...230 V AC/DC</p> <p>without components</p>	<p>6-pole</p> <p>6...230 V AC/DC</p> <p>without components</p>	
Circuit diagram			
Contact layout	<p>Male female contacts</p>	<p>Male female contacts</p>	
2 Cable Type	Jacket Color	Jacket Color	
<p>Wire diameter 0.75 mm²</p> <p>PUR (UL/CSA), robots/Ctracks</p>	<p>black</p> <p>569</p>	<p>black</p> <p>572</p>	
3 Cable Length			
1.5 m	0150		
3.0 m	0300		
5.0 m	0500		
7.5 m	0750		
10.0 m	1000		
Technical Data			
Operating voltage	6...230 V AC/DC		
Protection	IP68 inserted and tightened		
Temperature range	-25...+85 °C, depending on cable quality		
Article No.			
The composition of your article number is explained on page 3.1.i	<p><u>7 0 7 2</u> - - - - - - - - - -</p>		
	1 Form	2 Cable Type	3 Cable Length
Notes	Other versions on request. Differing cable lengths up to 2 m can be ordered in 0.2 m steps, from 2 m on in 0.5 m steps.		

Mobile Applications

MOBILE APPLICATIONS

Xtreme - Mobile Applications

- with open ended wires
- compatible with:
- Deutsch DT 06

Deutsch MDC 06-4S

Y connector
Male



1 Form		72191	
Type	4-/2-pole 6...230 V AC/DC without components		
Circuit diagram			
Contact layout	<p>Male female contacts</p>		
2 Cable Type		Jacket Color	
Wire diameter 0.75 mm ² PUR (UL/CSA), robots/Ctracks	black 754	yellow 145	
3 Cable Length			
1.5 m	0150		
3.0 m	0300		
5.0 m	0500		
7.5 m	0750		
10.0 m	1000		
Technical Data			
Operating voltage	6...230 V AC/DC		
Protection	IP68 inserted and tightened		
Temperature range	-25...+85 °C, depending on cable quality		
Article No.			
The composition of your article number is explained on page 3.1.i	<p><u>7 0 7 2</u> - <u>7 2 1 9 1</u> - _ _ _ _</p>		
	1 Form	2 Cable Type	3 Cable Length
Notes	Other versions on request. Differing cable lengths up to 2 m can be ordered in 0.2 m steps, from 2 m on in 0.5 m steps.		

MOBILE APPLICATIONS

Xtreme - Mobile Applications

- with open ended wires
- compatible with:
- Deutsch DT 06

Deutsch MDC 04-2P

Female straight



Deutsch MDC 04-3P

Female straight



1 Form

72301

72381

Type	2-pole 6...230 V AC/DC without components	3-pole 6...230 V AC/DC without components
Circuit diagram		
Contact layout	<p>Female male contacts</p>	<p>Female male contacts</p>

2 Cable Type

Jacket Color

Jacket Color

Wire diameter 0.75 mm ²	black	yellow	black
PUR/PVC	750		
PUR (UL/CSA), robots/Ctracks	754	145	564

3 Cable Length

1.5 m	0150
3.0 m	0300
5.0 m	0500
7.5 m	0750
10.0 m	1000

Technical Data

Operating voltage	6...230 V AC/DC
Protection	IP68 inserted and tightened
Temperature range	-25...+85 °C, depending on cable quality

Article No.

The composition of your article number is explained on page 3.1.i

7 0 7 2 - - - - -

1 Form

2 Cable Type

3 Cable Length

Notes

Other versions on request. Differing cable lengths up to 2 m can be ordered in 0.2 m steps, from 2 m on in 0.5 m steps.

MOBILE APPLICATIONS

Xtreme - Mobile Applications

- with open ended wires
- compatible with:
- Deutsch DT 06

Deutsch MDC 04-4P

Female straight



Deutsch MDC 04-6P

Female straight



1 Form	72461	72521
Type	4-pole 6...230 V AC/DC without components	6-pole 6...230 V AC/DC without components
Circuit diagram		
Contact layout	<p>Female male contacts</p>	<p>Female male contacts</p>
2 Cable Type	Jacket Color	Jacket Color
Wire diameter 0.75 mm ² PUR (UL/CSA), robots/Ctracks	black 569	black 572
3 Cable Length		
1.5 m	0150	
3.0 m	0300	
5.0 m	0500	
7.5 m	0750	
10.0 m	1000	
Technical Data		
Operating voltage	6...230 V AC/DC	
Protection	IP68 inserted and tightened	
Temperature range	-25...+85 °C, depending on cable quality	
Article No.		
The composition of your article number is explained on page 3.1.i	7 0 7 2 - - - - -	
	1 Form	2 Cable Type
		3 Cable Length
Notes	Other versions on request. Differing cable lengths up to 2 m can be ordered in 0.2 m steps, from 2 m on in 0.5 m steps.	

MOBILE APPLICATIONS

Xtreme - Mobile Applications

- with open ended wires
- compatible with:
- AMP SuperSeal 1.5

SuperSeal MSC1.5-2S

Male straight



SuperSeal MSC1.5-3S

Male straight



1 Form

73001

73081

Type

2-pole

3-pole

max. 24 V DC

max. 24 V DC

without components

without components

Circuit diagram

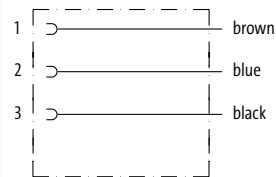
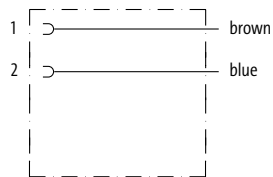

Contact layout

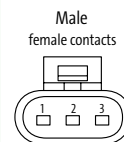
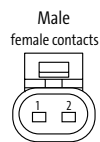

2 Cable Type

Jacket Color

Jacket Color

Wire diameter 0.75 mm²

black

black

PUR (UL), Ctracks

512

513

3 Cable Length

1.5 m

0150

3.0 m

0300

5.0 m

0500

7.5 m

0750

10.0 m

1000

Technical Data

Operating voltage

max. 24 V DC

Protection

IP67 inserted and tightened (EN 60529)

Temperature range

-40...+125 °C, depending on cable quality

Article No.

The composition of your article number is explained on page 3.1.i

7 0 7 2 - - - - -

1 Form

2 Cable Type

3 Cable Length

Notes

Other versions on request. Differing cable lengths up to 2 m can be ordered in 0.2 m steps, from 2 m on in 0.5 m steps.

MOBILE APPLICATIONS

Xtreme - Mobile Applications

- with open ended wires
- compatible with:
- AMP SuperSeal 1.5

SuperSeal MSC1.5-4S

Male straight



SuperSeal MSC1.5-6S

Male straight



1 Form	73161	73221	
	<p>Type</p> <p>4-pole max. 24 V DC without components</p>	<p>6-pole</p> <p>max. 24 V DC without components</p>	
Circuit diagram			
Contact layout			
2 Cable Type	Jacket Color	Jacket Color	
	<p>Wire diameter 0.75 mm² PUR (UL), C-tracks</p>	<p>black 514</p>	<p>black 516</p>
3 Cable Length	1.5 m	0150	
	3.0 m	0300	
	5.0 m	0500	
	7.5 m	0750	
	10.0 m	1000	
Technical Data	<p>Operating voltage: max. 24 V DC</p> <p>Protection: IP67 inserted and tightened (EN 60529)</p> <p>Temperature range: -40...+125 °C, depending on cable quality</p>		
Article No.	<p>The composition of your article number is explained on page 3.1.i</p> <p>7 0 7 2 - - - - - - - - - -</p>		
	1 Form	2 Cable Type	3 Cable Length
Notes	<p>Other versions on request. Differing cable lengths up to 2 m can be ordered in 0.2 m steps, from 2 m on in 0.5 m steps.</p>		

MOBILE APPLICATIONS

Xtreme - Mobile Applications

- with open ended wires
- compatible with:
- AMP SuperSeal 1.5

SuperSeal MSC1.5-2P

Female straight



SuperSeal MSC1.5-3P

Female straight



1 Form

73301

73381

Type

2-pole

3-pole

max. 24 V DC

max. 24 V DC

without components

without components

Circuit diagram

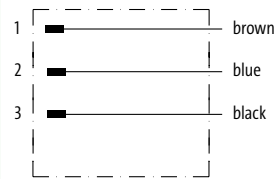
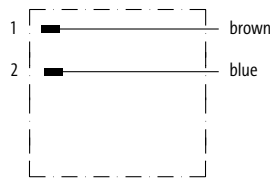

Contact layout

Female male contacts



Female male contacts

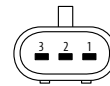

2 Cable Type

Jacket Color

Jacket Color

Wire diameter 0.75 mm²

black

black

PUR (UL), Ctracks

512

513

3 Cable Length

1.5 m	0150
3.0 m	0300
5.0 m	0500
7.5 m	0750
10.0 m	1000

Technical Data

Operating voltage	max. 24 V DC
Protection	IP67 inserted and tightened (EN 60529)
Temperature range	-40...+125 °C, depending on cable quality

Article No.

The composition of your article number is explained on page 3.1.i

7 0 7 2 - - - - -

1 Form

2 Cable Type

3 Cable Length

Notes

Other versions on request. Differing cable lengths up to 2 m can be ordered in 0.2 m steps, from 2 m on in 0.5 m steps.

MOBILE APPLICATIONS

Xtreme - Mobile Applications

- with open ended wires
- compatible with:
- AMP SuperSeal 1.5

SuperSeal MSC1.5-4P

Female straight



SuperSeal MSC1.5-6P

Female straight



1 Form	73461	73521
	Type	4-pole max. 24 V DC without components
Circuit diagram		
Contact layout		
2 Cable Type	Jacket Color	Jacket Color
	Wire diameter 0.75 mm ² PUR (UL), Ctracks	black 514
3 Cable Length	1.5 m	0150
	3.0 m	0300
	5.0 m	0500
	7.5 m	0750
	10.0 m	1000
Technical Data		
Operating voltage	max. 24 V DC	
Protection	IP67 inserted and tightened (EN 60529)	
Temperature range	-40...+125 °C, depending on cable quality	
Article No.		
The composition of your article number is explained on page 3.1.i	<div style="display: flex; justify-content: space-around; align-items: center;"> 7 0 7 2 - - </div>	
	1 Form	2 Cable Type
		3 Cable Length
Notes	Other versions on request. Differing cable lengths up to 2 m can be ordered in 0.2 m steps, from 2 m on in 0.5 m steps.	

M23 ROUND PLUG CONNECTORS MADE FOR DISTRIBUTION BOXES

- Highly resistant, halogen-free molding
- Safely sealed – acc. to IP67
- Reliable – 100% tested

COMPACT CONNECTOR FOR SAFE SIGNAL TRANSFER

Murrelektronik's M23 connectors are specially designed for distribution systems with M23 connections. They ensure a safe signal transfer from the distribution box to the control cabinet and a safe power supply to the distributor as well as the sensors and actuators connected to it.

With Open Ended Wires



M23 female, 12-pole

- Straight/90°
- For unshielded distribution boxes

Page 3.9.1



M23 female, 19-pole

- Straight/90°
- For unshielded distribution boxes

Page 3.9.2



M23 female, 19-pole

- Straight
- For shielded distribution boxes

Page 3.9.4

M23 ROUND PLUG CONNECTORS

With open ended wires

– 12-pole

Female
straight



Female
90°



1 Form	23051	23151
Type	11-pole used for 8-way distribution box, 4-pole	11-pole used for 8-way distribution box, 4-pole
Circuit diagram		
Contact layout	<p>Female</p>	
2 Cable Type	Jacket Color – No./diameter of wires	
PUR/PVC (UL/CSA), Ctracks	gray 362 – 8 × 0.34 + 3 × 0.75 mm ²	gray 362 – 8 × 0.34 + 3 × 0.75 mm ²
3 Cable Length		
5.0 m	0500	
10.0 m	1000	
15.0 m	1500	
Technical Data		
Operating voltage	max. 125 V AC/DC	
Protection	IP65 and IP67 when plugged and screwed down (EN 60529)	
Temperature range	-25...+85 °C, depending on cable quality	
Article No.		
The composition of your article number is explained on page 3.1.i	<p>7 0 0 0 – _____ – _____</p>	
	1 Form	2 Cable Type
		3 Cable Length
Notes	Other versions on request.	

M23 ROUND PLUG CONNECTORS

With open ended wires

– 19-pole

Female

straight



1 Form	23251	23251
Approvals		cULus
Type	19-pole used for 8-way distribution boxes, 5-pole	19-pole used for 8-way distribution boxes, 5-pole
Circuit diagram	<ul style="list-style-type: none"> 15 > white 7 > gray/pink 5 > green 4 > red/blue 16 > yellow 8 > white/green 3 > gray 14 > brown/green 17 > pink 9 > white/yellow 2 > red 13 > yellow/brown 11 > black 10 > white/gray 1 > violet 18 > gray/brown 19 > brown 0.75mm² 6 > blue 0.75mm² 12 > green/yellow 0.75mm² 	<ul style="list-style-type: none"> 15 > white 7 > gray/pink 5 > green 4 > red/blue 16 > yellow 8 > white/green 3 > gray 14 > brown/green 17 > pink 9 > white/yellow 2 > red 13 > yellow/brown 11 > black 10 > white/gray 1 > violet 18 > gray/brown 19 > brown 1.0mm² 6 > blue 1.0mm² 12 > green/yellow 1.0mm²
Contact layout	<p>Female</p>	
2 Cable Type	Jacket Color – No./diameter of wires	
	gray	gray
PUR/PVC (UL/CSA), Ctracks	398 – 16 × 0.34 + 3 × 0.75 mm ²	
PUR (UL/CSA), robots/Ctracks		452 – 16 × 0.5 + 3 × 1.0 mm ²
3 Cable Length		
5.0 m	0500	
10.0 m	1000	
15.0 m	1500	
Technical Data		
Operating voltage	max. 125 V AC/DC	
Protection	IP67 inserted and tightened (EN 60529)	
Temperature range	-5...+70 °C, depending on cable quality	-5...+70 °C, depending on cable quality
Article No.		
The composition of your article number is explained on page 3.1.i	<div style="display: flex; justify-content: space-around; align-items: center;"> 7 0 0 0 - - </div>	
	1 Form	2 Cable Type
		3 Cable Length
Notes	Other versions on request.	

M23 Round Plug Connectors

M23 ROUND PLUG CONNECTORS

With open ended wires

– 19-pole

Female
90°



1 Form	23351	23351
Approvals		cULus
Type	19-pole used for 8-way distribution boxes, 5-pole	19-pole used for 8-way distribution boxes, 5-pole
Circuit diagram	<ul style="list-style-type: none"> 15 ▷ white 7 ▷ gray/pink 5 ▷ green 4 ▷ red/blue 16 ▷ yellow 8 ▷ white/green 3 ▷ gray 14 ▷ brown/green 17 ▷ pink 9 ▷ white/yellow 2 ▷ red 13 ▷ yellow/brown 11 ▷ black 10 ▷ white/gray 1 ▷ violet 18 ▷ gray/brown 19 ▷ brown 0.75mm² 6 ▷ blue 0.75mm² 12 ▷ green/yellow 0.75mm² 	<ul style="list-style-type: none"> 15 ▷ white 7 ▷ gray/pink 5 ▷ green 4 ▷ red/blue 16 ▷ yellow 8 ▷ white/green 3 ▷ gray 14 ▷ brown/green 17 ▷ pink 9 ▷ white/yellow 2 ▷ red 13 ▷ yellow/brown 11 ▷ black 10 ▷ white/gray 1 ▷ violet 18 ▷ gray/brown 19 ▷ brown 1.0mm² 6 ▷ blue 1.0mm² 12 ▷ green/yellow 1.0mm²
Contact layout	Female 	
2 Cable Type	Jacket Color – No./diameter of wires	
	gray	gray
PUR/PVC (UL/CSA), Ctracks	398 – 16 × 0.34 + 3 × 0.75 mm ²	
PUR (UL/CSA), robots/Ctracks		452 – 16 × 0.5 + 3 × 1.0 mm ²
3 Cable Length		
5.0 m	0500	
10.0 m	1000	
15.0 m	1500	
Technical Data		
Operating voltage	max. 125 V AC/DC	
Protection	IP67 inserted and tightened (EN 60529)	
Temperature range	-5...+70 °C, depending on cable quality	-5...+70 °C, depending on cable quality
Article No.		
The composition of your article number is explained on page 3.1.i	7 0 0 0 – _____ – _____ – _____	
	1 Form	2 Cable Type
		3 Cable Length
Notes	Other versions on request.	

M23 ROUND PLUG CONNECTORS

With open ended wires

- 19-pole

Female
straight



1 Form	23711	23751
Type	11-pole used shielded for 4-way distribution boxes, 5-pole	19-pole used shielded for 8-way distribution boxes, 5-pole
Circuit diagram		
Contact layout	<p>Female</p>	
2 Cable Type	Jacket Color – No./diameter of wires	
	gray	gray
PUR (UL/CSA), robots/C-tracks	373 – 8 × 0.34 + 3 × 0.75 mm ²	401 – 16 × 0.34 + 3 × 0.75 mm ²
3 Cable Length		
5.0 m	0500	
10.0 m	1000	
15.0 m	1500	
Technical Data		
Operating voltage	max. 125 V AC/DC	
Protection	IP65 and IP67 when plugged and screwed down (EN 60529)	
Temperature range	-25...+85 °C, depending on cable quality	
Article No.		
The composition of your article number is explained on page 3.1.i	<div style="display: flex; justify-content: space-around; align-items: center;"> 7 0 0 0 - - </div>	
	1 Form	2 Cable Type
		3 Cable Length
Notes	Other versions on request.	

M23 Round Plug Connectors

ROUND PLUG CONNECTORS POWER POWERFUL AND SAFE

- Proven and reliable
- Molded and encapsulated plug connector
- Easy and safe connection



PLUG CONNECTOR FOR HIGH POWER TRANSFER

Perfect electrical connection, tightness and media resistance are the basic requirements for all types of plug connectors. In the field of motor connection technology, additional special properties are required: large connection cross-sections, high power with the smallest possible design and – most importantly – integrated anti-vibration locks that keeps the connector securely in place even if severe vibrations occur.

- The **M12 Power** is an extremely compact and performant M12 plug connector.
- The **MQ15 X-Power** enables particularly fast installation.
- The **7/8" round plug connector** has been optimized for highest performance

As a matter of course, all our plug connectors are tested 100%.

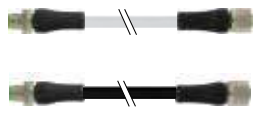
M12 Power

	<p>With open ended wires</p>	<p>M12 male/female</p> <ul style="list-style-type: none"> • Straight • K-coded, L-coded, S-coded, T-coded 	<p>Page 3.10.1</p>
	<p>Connection cables</p>	<p>M12 male – M12 female</p> <ul style="list-style-type: none"> • Straight • K-coded, L-coded, S-coded, T-coded 	<p>Page 3.10.5</p>
	<p>Field-wireable Screw terminals</p> <p>Field-wireable Terminals with Insulation Displacement Technology (IDC)</p>	<p>M12 male/female</p> <ul style="list-style-type: none"> • Straight • S-coded, T-coded <p>M12 male/female</p> <ul style="list-style-type: none"> • Straight • L-coded 	<p>Page 3.10.7</p>

MQ15 X-Power

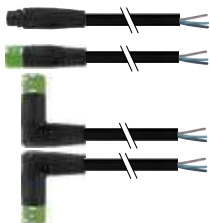

With open ended wires

MQ15 X-Power male/female

- Unshielded/shielded
- Straight
- 90°

Page 3.10.10



Connection cables

MQ15 X-Power male – MQ15 X-Power female

- Unshielded/shielded
- Straight

Page 3.10.25

7/8"

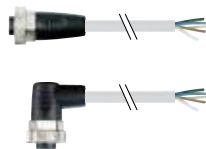

With open ended wires

7/8" male/female

- Straight/90°

Page 3.10.29

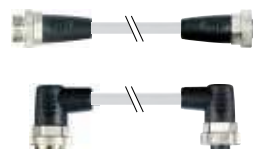

Connection cables

7/8" male – 7/8" female

- Straight/90°

Page 3.10.30



Field-wireable
Screw terminals

7/8" male/female

- Straight/90°

Page 3.10.31

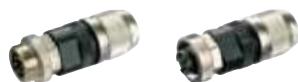

Field-wireable
Terminals with Insulation
Displacement Technology (IDC)

7/8" male/female

- Straight

Page 3.10.33

M23 Drives (Motors)



*We offer a wide range
for M23 Drives. Just talk to us!*

ROUND PLUG CONNECTORS POWER

With open ended wires

– M12 Power

Male

straight



1 Form		P3201	P4201
Type		5-pole K-coded Operating current: max. 12 A	5-pole L-coded Operating current: max. 16 A
Circuit diagram			
Contact layout			
2 Cable Type	Jacket Color		
Wire diameter 1.5 mm ² PUR/PVC PUR (UL/CSA), robots/Ctracks		black P05	gray 966 black P04
3 Cable Length			
1.5 m		0150	
3.0 m		0300	
5.0 m		0500	
7.5 m		0750	
10.0 m		1000	
Technical Data			
Operating voltage		max. 630 V AC/DC	max. 63 V AC/DC
Protection		IP65 and IP67 when plugged and screwed down (EN 60529)	
Temperature range		-25...+85 °C, depending on cable quality	
Article No.			
The composition of your article number is explained on page 3.1.i		7 0 0 0	— — — — —
		1 Form	2 Cable Type 3 Cable Length
Notes		Other versions on request. Differing cable lengths up to 2 m can be ordered in 0.2 m steps, from 2 m on in 0.5 m steps.	

ROUND PLUG CONNECTORS POWER

With open ended wires

– M12 Power

Female
straight



1 Form	P 3 2 2 1	P 4 2 2 1
Type	5-pole K-coded Operating current: max. 12 A	5-pole L-coded Operating current: max. 16 A
Circuit diagram		
Contact layout		
2 Cable Type	Jacket Color	Jacket Color
Wire diameter 1.5 mm ² PUR/PVC PUR (UL/CSA), robots/Ctracks	black P05	gray 966 black P04
3 Cable Length		
1.5 m	0150	
3.0 m	0300	
5.0 m	0500	
7.5 m	0750	
10.0 m	1000	
Technical Data		
Operating voltage	max. 630 V AC/DC	max. 63 V AC/DC
Protection	IP65 and IP67 when plugged and screwed down (EN 60529)	
Temperature range	-25...+85 °C, depending on cable quality	
Article No.		
The composition of your article number is explained on page 3.1.i	<div style="display: flex; align-items: center; justify-content: center;"> 7 0 0 0 - - - - - - </div>	
	1 Form	2 Cable Type
		3 Cable Length
Notes	Other versions on request. Differing cable lengths up to 2 m can be ordered in 0.2 m steps, from 2 m on in 0.5 m steps.	

Round Plug Connectors Power

ROUND PLUG CONNECTORS POWER

With open ended wires

– M12 Power

Male

straight



1 Form		P 6201	P 7201
Type		4-pole S-coded Operating current: max. 12 A	4-pole T-coded Operating current: max. 12 A
Circuit diagram			
Contact layout			
2 Cable Type		Jacket Color	Jacket Color
Wire diameter 1.5 mm ² PUR (UL/CSA), robots/Ctracks		black P06	black P07
3 Cable Length			
1.5 m		0150	
3.0 m		0300	
5.0 m		0500	
7.5 m		0750	
10.0 m		1000	
Technical Data			
Operating voltage		max. 630 V AC/DC	max. 63 V AC/DC
Protection		IP65 and IP67 when plugged and screwed down (EN 60529)	
Temperature range		-25...+85 °C, depending on cable quality	
Article No.			
The composition of your article number is explained on page 3.1.i		<u>7 0 0 0</u> - - - - - - - - - -	- - - - -
		1 Form	2 Cable Type 3 Cable Length
Notes		Other versions on request. Differing cable lengths up to 2 m can be ordered in 0.2 m steps, from 2 m on in 0.5 m steps.	

ROUND PLUG CONNECTORS POWER

With open ended wires

– M12 Power

Female
straight



1 Form	P 6221	P 7221
	Type	4-pole S-coded Operating current: max. 12 A
Circuit diagram		
Contact layout		
2 Cable Type	Jacket Color	Jacket Color
Wire diameter 1.5 mm ² PUR (UL/CSA), robots/Ctracks	black P06	black P07
3 Cable Length		
1.5 m	0150	
3.0 m	0300	
5.0 m	0500	
7.5 m	0750	
10.0 m	1000	
Technical Data		
Operating voltage	max. 630 V AC/DC	max. 63 V AC/DC
Protection	IP65 and IP67 when plugged and screwed down (EN 60529)	
Temperature range	-25...+85 °C, depending on cable quality	
Article No.		
The composition of your article number is explained on page 3.1.i	<div style="display: flex; justify-content: space-around; align-items: center;"> 7 0 0 0 - _ - _ _ _ </div>	
	1 Form	2 Cable Type
		3 Cable Length
Notes	Other versions on request. Differing cable lengths up to 2 m can be ordered in 0.2 m steps, from 2 m on in 0.5 m steps.	

Round Plug Connectors Power

ROUND PLUG CONNECTORS POWER

Connection cables

– M12 Power

Male
straight

Female
straight



1 Form		P3241	P4241
Type	5-pole K-coded Operating current: max. 12 A	5-pole L-coded Operating current: max. 16 A	
Circuit diagram			
Contact layout			
2 Cable Type		Jacket Color	Jacket Color
Wire diameter 1.5 mm ² PUR/PVC PUR (UL/CSA), robots/Ctracks		black P05	gray 966 black P04
3 Cable Length			
1.5 m		0150	
3.0 m		0300	
5.0 m		0500	
7.5 m		0750	
10.0 m		1000	
Technical Data			
Operating voltage		max. 630 V AC/DC	max. 63 V AC/DC
Protection		IP65 and IP67 when plugged and screwed down (EN 60529)	
Temperature range		-25...+85 °C, depending on cable quality	
Article No.			
The composition of your article number is explained on page 3.1.i		<div style="display: flex; justify-content: space-around; align-items: center;"> 7 0 0 0 - - - - </div>	
		1 Form	2 Cable Type
		3 Cable Length	
Notes		Other versions on request. Differing cable lengths up to 2 m can be ordered in 0.2 m steps, from 2 m on in 0.5 m steps.	

ROUND PLUG CONNECTORS POWER

Connection cables

– M12 Power

Male

straight

Female

straight



1 Form	P 6241	P 7241
Type	4-pole S-coded Operating current: max. 12 A	4-pole T-coded Operating current: max. 12 A
Circuit diagram		
Contact layout		
2 Cable Type	Jacket Color	Jacket Color
Wire diameter 1.5 mm ² PUR (UL/CSA), robots/Ctracks	black P06	black P07
3 Cable Length		
1.5 m	0150	
3.0 m	0300	
5.0 m	0500	
7.5 m	0750	
10.0 m	1000	
Technical Data		
Operating voltage	max. 630 V AC/DC	max. 63 V AC/DC
Protection	IP65 and IP67 when plugged and screwed down (EN 60529)	
Temperature range	-25...+85 °C, depending on cable quality	
Article No.		
The composition of your article number is explained on page 3.1.i	<div style="display: flex; justify-content: space-around; align-items: center;"> 7 0 0 0 - - </div>	
	1 Form	2 Cable Type
		3 Cable Length
Notes	Other versions on request. Differing cable lengths up to 2 m can be ordered in 0.2 m steps, from 2 m on in 0.5 m steps.	

Round Plug Connectors Power

ROUND PLUG CONNECTORS POWER

Field-wireable

– M12 Power

– Screw terminals

Approvals: 

Male
straight



Female
straight

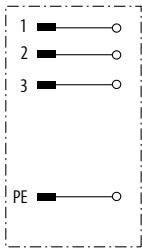
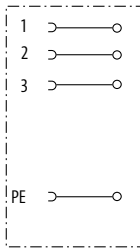
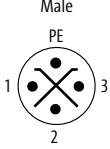
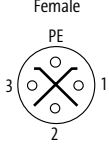

1 Form	P 6391	P 6411
Type	4-pole S-coded	4-pole S-coded
Circuit diagram		
Sealing range (cable Ø)	8...10 mm	
Contact layout	<p>Male</p> 	<p>Female</p> 
Technical Data		
Operating voltage	max. 630 V AC/DC	
Rated surge voltage	6 kV	
Operating current per contact	max. 12 A	
Material group	IEC 60664-1, category III	
Connection cross section	max. 1.5 mm ²	
Coding	S-coded	
Sealing range (cable Ø)	8...10 mm	
Locking of ports	Screw thread M12 × 1 mm (recommended torque 0.6 Nm) self-securing	
Protection	IP67 inserted and tightened (EN 60529)	
Material	PA	
suitable for corrugated tube (internal Ø)	without	
Temperature range	-40...+85 °C	
Article No.		
The composition of your article number is explained on page 3.1.i	<p style="text-align: center;"><u>7 0 0 0</u> - <u> </u> - <u>0 0 0</u> <u>0 0 0 0</u></p>	
1 Form		
Notes		
Other versions on request.		

ROUND PLUG CONNECTORS POWER

Field-wireable

– M12 Power

– Screw terminals

Approvals: 

Male

straight



Female

straight



1 Form

P7391

P7411

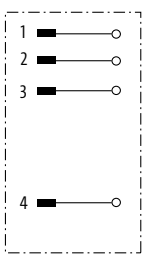
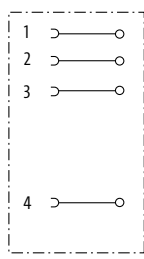
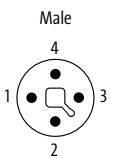
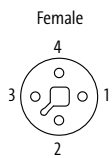
Type	4-pole T-coded	4-pole T-coded
Circuit diagram		
Sealing range (cable Ø)	8...10 mm	
Contact layout	<p>Male</p> 	<p>Female</p> 

Technical Data

Operating voltage	max. 63 V AC/DC
Rated surge voltage	1.5 kV
Operating current per contact	max. 12 A
Material group	IEC 60664-1, category III
Connection cross section	max. 1.5 mm ²
Coding	T-coded
Sealing range (cable Ø)	8...10 mm
Locking of ports	Screw thread M12 × 1 mm (recommended torque 0.6 Nm) self-securing
Protection	IP67 inserted and tightened (EN 60529)
Material	PA
suitable for corrugated tube (internal Ø)	without
Compression gland	M12 (SW18)
Temperature range	-40...+85 °C

Article No.

The composition of your article number is explained on page 3.1.i

7 0 0 0

-

0 0 0

0 0 0 0

1 Form

Notes

Other versions on request.

ROUND PLUG CONNECTORS POWER

Field-wireable

– M12 Power

– IDC terminals

Male

straight



Female

straight



1 Form	P4391	P4421
Type	5-pole L-coded	5-pole L-coded
Circuit diagram		
Contact layout	<p>Male</p>	<p>Female</p>
Technical Data		
Operating voltage	max. 63 V DC	
Operating current per contact	max. 12 A	
Connection cross section	max. 1.5 mm ²	
Coding	L-coded	
Sealing range (cable Ø)	5.8...13.5 mm	
Locking of ports	Screw thread M12 × 1 mm (recommended torque 0.6 Nm) self-securing	
Compression gland	M12 (SW17)	
Protection	IP65 and IP67 when plugged and screwed down (EN 60529)	
Material	Zinc die casting	
suitable for corrugated tube (internal Ø)	without	
Mating cycles	≥ 500	
Temperature range	-40...+85 °C	
Article No.		
The composition of your article number is explained on page 3.1.i	<p style="text-align: center;"> 7 0 0 0 - 0 0 0 - 0 0 0 0 </p>	
	<p>1 Form</p>	
Notes	Other versions on request.	

ROUND PLUG CONNECTORS POWER

With open ended wires

– MQ15 X-Power

Male

straight



1 Form	P 8101	P 8101
	6-pole max. 13 A (Power); max. 10 A (Signal)	6-pole max. 16 A (Power); max. 10 A (Signal)

Circuit diagram



Contact layout

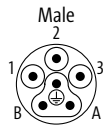

2 Cable Type	Jacket Color	Jacket Color
	Wire diameter 1.5 mm ² PVC (UL) PUR (UL), C-tracks Wire diameter 2.5 mm ² PUR (UL), C-tracks PVC (UL)	black P24 P84

3 Cable Length	1.0 m	0100
	2.0 m	0200
	3.0 m	0300
	5.0 m	0500
	10.0 m	1000

Technical Data

Operating voltage	max. 600 V AC (Power); max. 63 V AC/DC (Signal)
Protection	IP67 inserted and tightened (EN 60529)
Temperature range	-25...+80 °C, depending on cable quality

Article No.

The composition of your article number is explained on page 3.1.i

7 0 0 0 - - - - -

1 Form **2 Cable Type** **3 Cable Length**

Notes

Other versions on request. Differing cable lengths up to 2 m can be ordered in 0.2 m steps, from 2 m on in 0.5 m steps.

ROUND PLUG CONNECTORS POWER

With open ended wires

– MQ15 X-Power

Female
straight



1 Form	P 8121	P 8121
	Type 6-pole max. 13 A (Power); max. 10 A (Signal)	Type 6-pole max. 16 A (Power); max. 10 A (Signal)
Circuit diagram		
Contact layout		
2 Cable Type	Jacket Color	Jacket Color
Wire diameter 1.5 mm ² PVC (UL) PUR (UL), C-tracks	black P24 P84	black
Wire diameter 2.5 mm ² PUR (UL), C-tracks PVC (UL)		P01 P21
3 Cable Length		
1.0 m	0100	
2.0 m	0200	
3.0 m	0300	
5.0 m	0500	
10.0 m	1000	
Technical Data		
Operating voltage	max. 600 V AC (Power); max. 63 V AC/DC (Signal)	
Protection	IP67 inserted and tightened (EN 60529)	
Temperature range	-25...+80 °C, depending on cable quality	
Article No.		
The composition of your article number is explained on page 3.1.i	<div style="display: flex; justify-content: space-between; align-items: center;"> 7 0 0 0 – – – </div>	
	1 Form	2 Cable Type
		3 Cable Length
Notes	Other versions on request. Differing cable lengths up to 2 m can be ordered in 0.2 m steps, from 2 m on in 0.5 m steps.	

ROUND PLUG CONNECTORS POWER

With open ended wires

– MQ15 X-Power

Male

straight



1 Form

P 8201

P 8201

Type	4-pole Operating current: max. 13 A	4-pole Operating current: max. 16 A
Circuit diagram		
Contact layout		

2 Cable Type

Jacket Color

Jacket Color

Wire diameter 1.5 mm ²	black	black
PVC (UL)	P22	
PUR (UL), C-tracks	P02	
Wire diameter 2.5 mm ²		
PUR (UL), C-tracks		P03
PVC (UL)		P23

3 Cable Length

1.0 m	0100
2.0 m	0200
3.0 m	0300
5.0 m	0500
10.0 m	1000

Technical Data

Operating voltage	max. 600 V AC
Protection	IP67 inserted and tightened (EN 60529)
Temperature range	-25...+80 °C, depending on cable quality

Article No.

The composition of your article number is explained on page 3.1.i

7 0 0 0 - - - - -

1 Form

2 Cable Type

3 Cable Length

Notes

Other versions on request. Differing cable lengths up to 2 m can be ordered in 0.2 m steps, from 2 m on in 0.5 m steps.

ROUND PLUG CONNECTORS POWER

With open ended wires

– MQ15 X-Power

Female
straight



1 Form		P 8 2 2 1	P 8 2 2 1
Type	4-pole	Operating current: max. 13 A	4-pole Operating current: max. 16 A
Circuit diagram			
Contact layout			
2 Cable Type		Jacket Color	Jacket Color
Wire diameter 1.5 mm ²		black	black
PVC (UL)		P22	
PUR (UL), C-tracks		P02	
Wire diameter 2.5 mm ²			
PUR (UL), C-tracks			P03
PVC (UL)			P23
3 Cable Length			
1.0 m	0100		
2.0 m	0200		
3.0 m	0300		
5.0 m	0500		
10.0 m	1000		
Technical Data			
Operating voltage	max. 600 V AC		
Protection	IP67 inserted and tightened (EN 60529)		
Temperature range	-25...+80 °C, depending on cable quality		
Article No.			
The composition of your article number is explained on page 3.1.i		7 0 0 0 - - - - -	- - - - -
	1 Form	2 Cable Type	3 Cable Length
Notes			
		Other versions on request. Differing cable lengths up to 2 m can be ordered in 0.2 m steps, from 2 m on in 0.5 m steps.	

ROUND PLUG CONNECTORS POWER

With open ended wires

– MQ15 X-Power

Female

90°



1 Form	P 8131	P 8131	
	6-pole max. 13 A (Power); max. 10 A (Signal)	6-pole max. 16 A (Power); max. 10 A (Signal)	
Circuit diagram			
Contact layout			
2 Cable Type	Jacket Color	Jacket Color	
	Wire diameter 1.5 mm ²	black	black
	PVC (UL)	P24	
	PUR (UL), C-tracks	P84	
	Wire diameter 2.5 mm ²		
	PUR (UL), C-tracks		P01
PVC (UL)		P21	
3 Cable Length	1.0 m	0100	
	2.0 m	0200	
	3.0 m	0300	
	5.0 m	0500	
	10.0 m	1000	
	Technical Data		
Operating voltage	max. 600 V AC (Power); max. 63 V AC/DC (Signal)		
Protection	IP67 inserted and tightened (EN 60529)		
Temperature range	-25...+80 °C, depending on cable quality		
Article No.			
The composition of your article number is explained on page 3.1.i	7 0 0 0	-	-
	1 Form	2 Cable Type	3 Cable Length
Notes	Other versions on request. Differing cable lengths up to 2 m can be ordered in 0.2 m steps, from 2 m on in 0.5 m steps.		

Round Plug Connectors Power

ROUND PLUG CONNECTORS POWER

With open ended wires

– MQ15 X-Power

Female

90°



1 Form	P 8132	P 8132
Type	6-pole max. 13 A (Power); max. 10 A (Signal)	6-pole max. 16 A (Power); max. 10 A (Signal)
Circuit diagram		
Contact layout		
2 Cable Type	Jacket Color	Jacket Color
Wire diameter 1.5 mm ²	black	black
PVC (UL)	P24	
PUR (UL), C-tracks	P84	
Wire diameter 2.5 mm ²		
PUR (UL), C-tracks		P01
PVC (UL)		P21
3 Cable Length		
1.0 m	0100	
2.0 m	0200	
3.0 m	0300	
5.0 m	0500	
10.0 m	1000	
Technical Data		
Operating voltage	max. 600 V AC (Power); max. 63 V AC/DC (Signal)	
Protection	IP67 inserted and tightened (EN 60529)	
Temperature range	-25...+80 °C, depending on cable quality	
Article No.		
The composition of your article number is explained on page 3.1.i	<div style="display: flex; justify-content: space-around; align-items: center;"> 7 0 0 0 - - - - - </div>	
	1 Form	2 Cable Type
		3 Cable Length
Notes	Other versions on request. Differing cable lengths up to 2 m can be ordered in 0.2 m steps, from 2 m on in 0.5 m steps.	

ROUND PLUG CONNECTORS POWER

With open ended wires

– MQ15 X-Power

Male

90°



1 Form

P 8 2 1 1

Type

4-pole

Operating current: max. 13 A

Circuit diagram

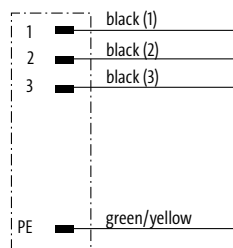

Contact layout

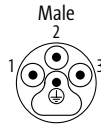

2 Cable Type

Jacket Color

Wire diameter 1.5 mm²

black

PVC (UL)

P22

3 Cable Length

1.0 m	0100
2.0 m	0200
3.0 m	0300
5.0 m	0500
10.0 m	1000

Technical Data

Operating voltage	max. 600 V AC
Protection	IP67 inserted and tightened (EN 60529)
Temperature range	-25...+80 °C, depending on cable quality

Article No.

The composition of your article number is explained on page 3.1.i

7 0 0 0

–

P 8 2 1 1

–

– – – –

– – – –

1 Form

2 Cable Type

3 Cable Length

Notes

Other versions on request. Differing cable lengths up to 2 m can be ordered in 0.2 m steps, from 2 m on in 0.5 m steps.

ROUND PLUG CONNECTORS POWER

With open ended wires

– MQ15 X-Power

Female

90°



1 Form	P 8231	P 8231
	4-pole Operating current: max. 13 A	4-pole Operating current: max. 16 A
Circuit diagram		
Contact layout		
2 Cable Type	Jacket Color	Jacket Color
Wire diameter 1.5 mm ²	black	black
PVC (UL)	P22	
PUR (UL), C-tracks	P02	
Wire diameter 2.5 mm ²		
PUR (UL), C-tracks		P03
PVC (UL)		P23
3 Cable Length		
1.0 m	0100	
2.0 m	0200	
3.0 m	0300	
5.0 m	0500	
10.0 m	1000	
Technical Data		
Operating voltage	max. 600 V AC	
Protection	IP67 inserted and tightened (EN 60529)	
Temperature range	-25...+80 °C, depending on cable quality	
Article No.		
The composition of your article number is explained on page 3.1.i	7 0 0 0 - - - - - - - - - -	
	1 Form	2 Cable Type
		3 Cable Length
Notes	Other versions on request. Differing cable lengths up to 2 m can be ordered in 0.2 m steps, from 2 m on in 0.5 m steps.	

ROUND PLUG CONNECTORS POWER

With open ended wires

– MQ15 X-Power

Female

90°



1 Form

P 8 2 3 2

P 8 2 3 2

Type	4-pole Operating current: max. 13 A	4-pole Operating current: max. 16 A
Circuit diagram		
Contact layout		

2 Cable Type

Jacket Color

Jacket Color

Wire diameter 1.5 mm ²	black	black
PVC (UL)	P22	
PUR (UL), C-tracks	P02	
Wire diameter 2.5 mm ²		
PUR (UL), C-tracks		P03
PVC (UL)		P23

3 Cable Length

1.0 m	0100
2.0 m	0200
3.0 m	0300
5.0 m	0500
10.0 m	1000

Technical Data

Operating voltage	max. 600 V AC
Protection	IP67 inserted and tightened (EN 60529)
Temperature range	-25...+80 °C, depending on cable quality

Article No.

The composition of your article number is explained on page 3.1.i

7 0 0 0 - - - - -

1 Form

2 Cable Type

3 Cable Length

Notes

Other versions on request. Differing cable lengths up to 2 m can be ordered in 0.2 m steps, from 2 m on in 0.5 m steps.

ROUND PLUG CONNECTORS POWER

With open ended wires

– MQ15 X-Power

Male
straight



Female
straight



1 Form	P8301	P8321
Type	6-pole, shielded max. 16 A (Power); max. 10 A (Signal)	6-pole, shielded max. 16 A (Power); max. 10 A (Signal)
Circuit diagram		
Contact layout		
2 Cable Type	Jacket Color	
4x2.5 + 2x1.5 mm ² PUR (UL), C-tracks	orange P11	orange P11
3 Cable Length		
1.0 m	0100	
2.0 m	0200	
3.0 m	0300	
5.0 m	0500	
10.0 m	1000	
Technical Data		
Operating voltage	max. 600 V AC (Power); max. 63 V AC/DC (Signal)	
Protection	IP67 inserted and tightened (EN 60529)	
Temperature range	-25...+80 °C, depending on cable quality	
Article No.		
The composition of your article number is explained on page 3.1.i	<div style="display: flex; justify-content: space-around; align-items: center;"> 7 0 0 0 - - - - - </div>	
	1 Form	2 Cable Type
Notes	Other versions on request. Differing cable lengths up to 2 m can be ordered in 0.2 m steps, from 2 m on in 0.5 m steps.	

ROUND PLUG CONNECTORS POWER

With open ended wires

– MQ15 X-Power

Male

straight



1 Form	P 8001	P 8001									
	4-pole, shielded Operating current: max. 13 A	4-pole, shielded Operating current: max. 16 A									
Circuit diagram											
Contact layout											
2 Cable Type	Jacket Color	Jacket Color									
	Wire diameter 1.5 mm ² PUR (UL), C-tracks	orange P12	orange								
Wire diameter 2.5 mm ² PUR (UL), C-tracks		P13									
3 Cable Length	1.0 m	0100									
	2.0 m	0200									
	3.0 m	0300									
	5.0 m	0500									
	10.0 m	1000									
Technical Data											
Operating voltage	max. 600 V AC										
Protection	IP67 inserted and tightened (EN 60529)										
Temperature range	-25...+80 °C, depending on cable quality										
Article No.											
The composition of your article number is explained on page 3.1.i	<table border="1"> <tr> <td><u>7</u></td> <td><u>0</u></td> <td><u>0</u></td> <td><u>0</u></td> <td>-</td> <td>---</td> <td>-</td> <td>---</td> <td>---</td> </tr> </table>		<u>7</u>	<u>0</u>	<u>0</u>	<u>0</u>	-	---	-	---	---
<u>7</u>	<u>0</u>	<u>0</u>	<u>0</u>	-	---	-	---	---			
	1 Form	2 Cable Type	3 Cable Length								
Notes	Other versions on request. Differing cable lengths up to 2 m can be ordered in 0.2 m steps, from 2 m on in 0.5 m steps.										

ROUND PLUG CONNECTORS POWER

With open ended wires

– MQ15 X-Power

Female

straight



1 Form	P8021	P8021
	Type 4-pole, shielded Operating current: max. 13 A	Type 4-pole, shielded Operating current: max. 16 A
Circuit diagram		
Contact layout		
2 Cable Type	Jacket Color	Jacket Color
Wire diameter 1.5 mm ² PUR (UL), C-tracks	orange P12	orange
Wire diameter 2.5 mm ² PUR (UL), C-tracks		P13
3 Cable Length		
1.0 m	0100	
2.0 m	0200	
3.0 m	0300	
5.0 m	0500	
10.0 m	1000	
Technical Data		
Operating voltage	max. 600 V AC	
Protection	IP67 inserted and tightened (EN 60529)	
Temperature range	-25...+80 °C, depending on cable quality	
Article No.		
The composition of your article number is explained on page 3.1.i	<div style="display: flex; justify-content: space-around; align-items: center;"> 7 0 0 0 - - </div>	
	1 Form	2 Cable Type
		3 Cable Length
Notes	Other versions on request. Differing cable lengths up to 2 m can be ordered in 0.2 m steps, from 2 m on in 0.5 m steps.	

ROUND PLUG CONNECTORS POWER

With open ended wires

– MQ15 X-Power

Female

90°

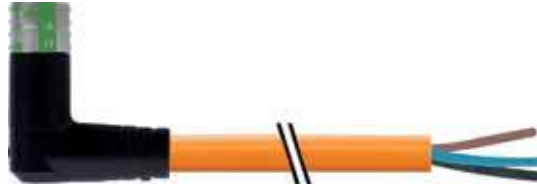

1 Form	P 8331	P 8332
	Type 6-pole, shielded max. 16 A (Power); max. 10 A (Signal)	Type 6-pole, shielded max. 16 A (Power); max. 10 A (Signal)
Circuit diagram		
Contact layout		
2 Cable Type	Jacket Color	Jacket Color
	4×2.5 + 2×1.5 mm ² PUR (UL), C-tracks	orange P11
3 Cable Length	1.0 m	0100
	2.0 m	0200
	3.0 m	0300
	5.0 m	0500
	10.0 m	1000
	Technical Data	
Operating voltage	max. 600 V AC (Power); max. 63 V AC/DC (Signal)	
Protection	IP67 inserted and tightened (EN 60529)	
Temperature range	-25...+80 °C, depending on cable quality	
Article No.		
The composition of your article number is explained on page 3.1.i	<div style="display: flex; justify-content: space-around; align-items: center;"> 7 0 0 0 - _ _ _ - _ _ _ </div>	
	1 Form	2 Cable Type
		3 Cable Length
Notes	Other versions on request. Differing cable lengths up to 2 m can be ordered in 0.2 m steps, from 2 m on in 0.5 m steps.	

Round Plug Connectors Power

ROUND PLUG CONNECTORS POWER

With open ended wires

– MQ15 X-Power

Female

90°



1 Form	P8031	P8031
	Type 4-pole, shielded Operating current: max. 13 A	Type 4-pole, shielded Operating current: max. 16 A
Circuit diagram		
Contact layout		
2 Cable Type	Jacket Color	Jacket Color
Wire diameter 1.5 mm ² PUR (UL), C-tracks	orange P12	orange
Wire diameter 2.5 mm ² PUR (UL), C-tracks		P13
3 Cable Length		
1.0 m	0100	
2.0 m	0200	
3.0 m	0300	
5.0 m	0500	
10.0 m	1000	
Technical Data		
Operating voltage	max. 600 V AC	
Protection	IP67 inserted and tightened (EN 60529)	
Temperature range	-25...+80 °C, depending on cable quality	
Article No.		
The composition of your article number is explained on page 3.1.i	<div style="display: flex; justify-content: space-around; align-items: center;"> 7 0 0 0 - _ - _ _ _ </div>	
	1 Form	2 Cable Type
		3 Cable Length
Notes	Other versions on request. Differing cable lengths up to 2 m can be ordered in 0.2 m steps, from 2 m on in 0.5 m steps.	

ROUND PLUG CONNECTORS POWER

With open ended wires

– MQ15 X-Power

Female

90°



1 Form	P 8 0 3 2	P 8 0 3 2									
	Type 4-pole, shielded Operating current: max. 13 A	Type 4-pole, shielded Operating current: max. 16 A									
Circuit diagram											
Contact layout											
2 Cable Type	Jacket Color	Jacket Color									
	Wire diameter 1.5 mm ² PUR (UL), C-tracks	orange P12	orange								
Wire diameter 2.5 mm ² PUR (UL), C-tracks		P13									
3 Cable Length	1.0 m	0100									
	2.0 m	0200									
	3.0 m	0300									
	5.0 m	0500									
	10.0 m	1000									
	Technical Data										
Operating voltage	max. 600 V AC										
Protection	IP67 inserted and tightened (EN 60529)										
Temperature range	-25...+80 °C, depending on cable quality										
Article No.											
The composition of your article number is explained on page 3.1.i	<table border="1"> <tr> <td><u>7</u></td> <td><u>0</u></td> <td><u>0</u></td> <td><u>0</u></td> <td>-</td> <td>---</td> <td>-</td> <td>---</td> <td>---</td> </tr> </table>		<u>7</u>	<u>0</u>	<u>0</u>	<u>0</u>	-	---	-	---	---
<u>7</u>	<u>0</u>	<u>0</u>	<u>0</u>	-	---	-	---	---			
	1 Form	2 Cable Type	3 Cable Length								
Notes	Other versions on request. Differing cable lengths up to 2 m can be ordered in 0.2 m steps, from 2 m on in 0.5 m steps.										

ROUND PLUG CONNECTORS POWER

Connection cables

– MQ15 X-Power

Male

straight

Female

straight



1 Form	P 8241	P 8241
	4-pole Operating current: max. 13 A	4-pole Operating current: max. 16 A
Circuit diagram		
Contact layout		
2 Cable Type	Jacket Color	Jacket Color
Wire diameter 1.5 mm ²	black	black
PVC (UL)	P22	
PUR (UL), C-tracks	P02	
Wire diameter 2.5 mm ²		
PUR (UL), C-tracks		P03
PVC (UL)		P23
3 Cable Length		
1.0 m	0100	
2.0 m	0200	
3.0 m	0300	
5.0 m	0500	
10.0 m	1000	
Technical Data		
Operating voltage	max. 600 V AC	
Protection	IP67 inserted and tightened (EN 60529)	
Temperature range	-25...+80 °C, depending on cable quality	
Article No.		
The composition of your article number is explained on page 3.1.i	<div style="display: flex; justify-content: space-around; align-items: center;"> 7 0 0 0 - - - - - </div>	
	1 Form	2 Cable Type
		3 Cable Length
Notes	Other versions on request. Differing cable lengths up to 2 m can be ordered in 0.2 m steps, from 2 m on in 0.5 m steps.	

ROUND PLUG CONNECTORS POWER

Connection cables

– MQ15 X-Power

Male

straight

Female

straight



1 Form	P 8141	P 8141
	6-pole max. 13 A (Power); max. 10 A (Signal)	6-pole max. 16 A (Power); max. 10 A (Signal)
Circuit diagram		
Contact layout		
2 Cable Type	Jacket Color	Jacket Color
Wire diameter 1.5 mm ²	black	black
PVC (UL)	P24	
PUR (UL), C-tracks	P84	
Wire diameter 2.5 mm ²		
PUR (UL), C-tracks		P01
PVC (UL)		P21
3 Cable Length		
1.0 m	0100	
2.0 m	0200	
3.0 m	0300	
5.0 m	0500	
10.0 m	1000	
Technical Data		
Operating voltage	max. 600 V AC (Power); max. 63 V AC/DC (Signal)	
Protection	IP67 inserted and tightened (EN 60529)	
Temperature range	-25...+80 °C, depending on cable quality	
Article No.		
The composition of your article number is explained on page 3.1.i	<div style="display: flex; justify-content: space-around; align-items: center;"> 7 0 0 0 - - </div>	
	1 Form	2 Cable Type
		3 Cable Length
Notes	Other versions on request. Differing cable lengths up to 2 m can be ordered in 0.2 m steps, from 2 m on in 0.5 m steps.	

Round Plug Connectors Power

ROUND PLUG CONNECTORS POWER

Connection cables

– MQ15 X-Power

Male
straight

Female
straight



1 Form	P8041	P8041
	Type 4-pole, shielded Operating current: max. 13 A	Type 4-pole, shielded Operating current: max. 16 A
Circuit diagram		
Contact layout		
2 Cable Type	Jacket Color	Jacket Color
	Wire diameter 1.5 mm ² PUR (UL), C-tracks	orange P12
Wire diameter 2.5 mm ² PUR (UL), C-tracks		P13
3 Cable Length	1.0 m	0100
	2.0 m	0200
	3.0 m	0300
	5.0 m	0500
	10.0 m	1000
Technical Data	Operating voltage	max. 600 V AC
	Protection	IP67 inserted and tightened (EN 60529)
	Temperature range	-25...+80 °C, depending on cable quality
Article No.		
The composition of your article number is explained on page 3.1.i	<div style="display: flex; justify-content: space-around; align-items: center;"> 7 0 0 0 - - - - - - </div>	
	1 Form	2 Cable Type
		3 Cable Length
Notes	Other versions on request. Differing cable lengths up to 2 m can be ordered in 0.2 m steps, from 2 m on in 0.5 m steps.	

ROUND PLUG CONNECTORS POWER

Connection cables

– MQ15 X-Power

Male

straight

Female

straight



1 Form

P 8341

Type

6-pole, shielded

max. 16 A (Power); max. 10 A (Signal)

Circuit diagram

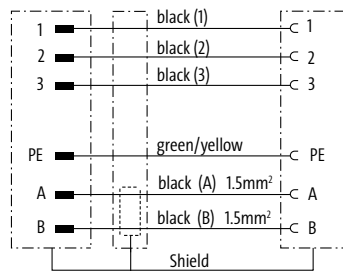

Contact layout

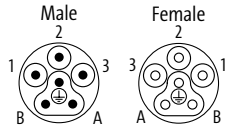

2 Cable Type

Jacket Color

4×2.5 + 2×1.5 mm²

PUR (UL), C-tracks

orange

P11

3 Cable Length

1.0 m

0100

2.0 m

0200

3.0 m

0300

5.0 m

0500

10.0 m

1000

Technical Data

Operating voltage

max. 600 V AC (Power); max. 63 V AC/DC (Signal)

Protection

IP67 inserted and tightened (EN 60529)

Temperature range

-25...+80 °C, depending on cable quality

Article No.

The composition of your article number is explained on page 3.1.i

7 0 0 0

-

P 8 3 4 1

-

1 Form

2 Cable Type

3 Cable Length

Notes

Other versions on request. Differing cable lengths up to 2 m can be ordered in 0.2 m steps, from 2 m on in 0.5 m steps.

ROUND PLUG CONNECTORS POWER

With open ended wires

- 7/8"

Female
straight



Female
90°



Approvals: 

* only for products with UL/CSA approved cable

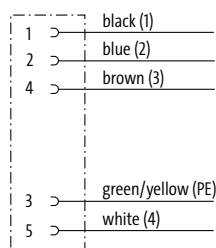
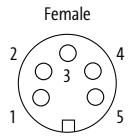
1 Form		78021	78051
Type		5-pole Power cable	5-pole Power cable
Circuit diagram			
Contact layout			
2 Cable Type		Jacket Color	Jacket Color
Wire diameter 1.0 mm ² PUR/PVC		gray 965	gray 965
Wire diameter 2.5 mm ² PUR (UL/CSA), robots/C-tracks		962	962
Wire diameter 1.5 mm ² PUR (UL/CSA), robots/C-tracks		961	961
3 Cable Length			
1.5 m		0150	
3.0 m		0300	
5.0 m		0500	
7.5 m		0750	
10.0 m		1000	
Technical Data			
Operating voltage		max. 230/400 V AC/DC	
Protection		IP67 inserted and tightened (EN 60529)	
Temperature range		-25...+85 °C, depending on cable quality	
Article No.			
The composition of your article number is explained on page 3.1.i		<u>7 0 0 0</u> - - - - -	- - - - -
		1 Form	2 Cable Type
			3 Cable Length
Notes			
		Other versions on request. Differing cable lengths up to 2 m can be ordered in 0.2 m steps, from 2 m on in 0.5 m steps.	

ROUND PLUG CONNECTORS POWER

Connection cables

- 7/8"



* only for products with UL/CSA approved cable

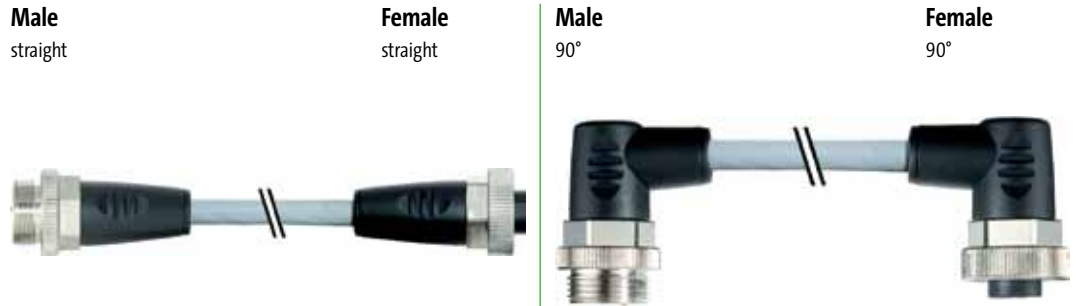

1 Form		50021	50051
Type		5-pole Power cable	5-pole Power cable
Circuit diagram			
Contact layout			
2 Cable Type		Jacket Color	Jacket Color
Wire diameter 1.0 mm ² PUR/PVC		gray 965	gray 965
Wire diameter 2.5 mm ² PUR (UL/CSA), robots/C-tracks		962	962
Wire diameter 1.5 mm ² PUR (UL/CSA), robots/C-tracks		961	961
3 Cable Length			
0.3 m		0030	
0.6 m		0060	
1.0 m		0100	
1.5 m		0150	
2.0 m		0200	
Technical Data			
Operating voltage		max. 230/400 V AC/DC	
Protection		IP67 inserted and tightened (EN 60529)	
Temperature range		-25...+85 °C, depending on cable quality	
Article No.			
The composition of your article number is explained on page 3.1.i		<u>7</u> <u>0</u> <u>0</u> <u>0</u> - - - - - - - - - -	- - - - -
		1 Form	2 Cable Type 3 Cable Length
Notes			
		Other versions on request. Differing cable lengths up to 2 m can be ordered in 0.2 m steps, from 2 m on in 0.5 m steps.	

ROUND PLUG CONNECTORS POWER

Field-wireable

- 7/8"

- Screw terminals

Male

straight



Male

90°

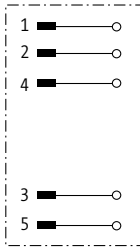
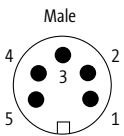

Approvals:  us

1 Form	78081	meX	78101	meX	78141	meX
Type	5-pole		5-pole		5-pole	
Circuit diagram						
Sealing range (cable Ø)	6...8 mm		10...12 mm		6...8.7 mm	
Contact layout						
Technical Data						
Operating voltage	max. 250 V AC/DC					
Operating current per contact	max. 9 A					
Connection cross section	max. 1.5 mm ²					
Sealing range (cable Ø)	6...8 mm		10...12 mm		6...8.7 mm	
Locking of ports	Screw thread 7/8" (recommended torque 1.5 Nm) self-securing					
Protection	IP67 inserted and tightened (EN 60529)					
Temperature range	-25...+85 °C					
Article No.						
The composition of your article number is explained on page 3.1.i	<u>7 0 0 0</u>		<u>0 0 0</u>		<u>0 0 0 0</u>	
	1 Form					
Notes	Other versions on request.					

ROUND PLUG CONNECTORS POWER

Field-wireable

- 7/8"

- Screw terminals

Approvals:  US

Female

straight



Female

90°

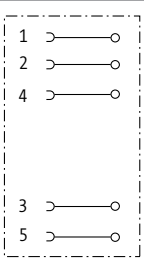
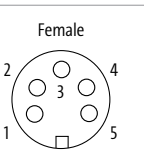

1 Form	78201	me \times	78221	me \times	78261	me \times
Type	5-pole		5-pole		5-pole	
Circuit diagram						
Sealing range (cable Ø)	6...8 mm		10...12 mm		6...8.7 mm	
Contact layout						
Technical Data						
Operating voltage	max. 250 V AC/DC					
Operating current per contact	max. 9 A					
Connection cross section	max. 1.5 mm ²					
Sealing range (cable Ø)	6...8 mm		10...12 mm		6...8.7 mm	
Protection	IP67 inserted and tightened (EN 60529)					
Locking of ports	Screw thread 7/8" (recommended torque 1.5 Nm) self-securing					
Locking material	Zinc die casting, matte nickel plated					
Temperature range	-25...+85 °C					
Article No.						
The composition of your article number is explained on page 3.1.i	<u>7 0 0 0</u>		<u>0 0 0</u>		<u>0 0 0 0</u>	
	1 Form					
Notes	Other versions on request.					

ROUND PLUG CONNECTORS POWER

Field-wireable

- 7/8"

- IDC terminals

Male

straight



Female

straight



1 Form	78091	me	78211	me
Type	5-pole		5-pole	
Circuit diagram				
Connection cross section	0.75...1.5 mm ²			
Contact layout	<p>Male</p>		<p>Female</p>	
Technical Data				
Operating voltage	max. 230/400 V AC/DC			
Rated surge voltage	4 kV			
Operating current per contact	max. 10 A			
Material group	IEC 60664-1, category I			
Connection cross section	0.75...1.5 mm ² (conductor diameter min. 0.15 mm)			
Coding	A-coded, 5-pole			
Sealing range (cable Ø)	6.8...9.5 mm			
Wire isolation	PVC, PP, TPE			
Outer wire Ø	max. 2.8 mm			
Locking of ports	Screw thread 7/8" (recommended torque 1.5 Nm) self-securing			
Protection	IP65 and IP67 when plugged and screwed down (EN 60529)			
Locking material	Brass			
Temperature range	-40...+85 °C			
Article No.				
The composition of your article number is explained on page 3.1.i	<div style="display: flex; justify-content: space-around; align-items: center;"> <u>7</u> <u>0</u> <u>0</u> <u>0</u> - _____ - <u>0</u> <u>0</u> <u>0</u> <u>0</u> <u>0</u> <u>0</u> <u>0</u> </div>			
	1 Form			
Notes	Other versions on request.			

ROUND PLUG CONNECTORS POWER

Connection accessories			Art-No.
	Flange 7/8" male, pre-wired 0.2 m 5-pole	7/8" Round Plug Connectors	7000-78341-9780020
	Flange 7/8" female, pre-wired 0.2 m 5-pole	7/8" Round Plug Connectors	7000-78381-9780020
	Control cabinet entry system 7/8"	7/8" Round Plug Connectors Ethernet CAT5	7000-50111-0000000
	T-coupler 7/8"-7/8", female/male 5-pole		7000-50061-0000000
Mounting accessories			Art-No.
	Torque wrench set 7/8" (1.5 Nm, SW22)	7/8" data connenctor moulded (IDC terminal)	7000-99104-0000000
	Torque wrench set 7/8" (1.5 Nm, SW24)	7700-XXXXX - 7/8" data connenctor moulded (screw terminals)	7000-99105-0000000
	Torque wrench 7/8" (1.5 Nm, SW22)	7/8" data connenctor moulded (IDC terminal)	7000-99096-0000000
	Torque wrench 7/8" (1.5 Nm, SW24)	7700-XXXXX - 7/8" data connenctor moulded (screw terminals)	7000-99097-0000000



TPE SERIES – THE NORTH AMERICAN STANDARD

- Product range RJ45, M12, 7/8"
- High material resistance
- Reliable – 100% tested

FROM SIGNAL AND DATA TO POWER

Our Ethernet products developed for the requirements of the North American market use shielded UL-approved cables and are approved for a voltage of 600 V.

The 4- and 8-pole cables are available in a great variety of configurations. The three cable types are suitable for moving applications, fulfil the CAT5 requirements and are resistant against different media such as welding sparks, oils and UV radiation. The S7V cable is ITC/PLTC/CMX-Outdoor-approved and suitable for PROFINET.

The MINI-A (7/8") cables are the perfect solution for current and switching circuit connections. The cables are cULus-listed. Available with 3, 4 and 5 pole and all configurations of head types. The range of 600 V cables in AWG 16 includes a TC-ER-approved TPR variant with flame resistance FT4 and a halogen-free PUR type.

Signal



M12 male

- Straight
- 90°

Page 3.11.1

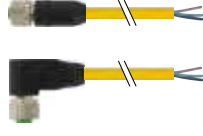

M12 female

- Straight
- 90°

Page 3.11.3



M12 male

- Straight
- 90°

M12 female

- Straight
- 90°

Page 3.11.5

Data



M12 male (shielded)

- Straight
- 90°

EtherNet/IP
PROFINET
EtherCAT

Page 3.11.9



M12 female flange plug (shielded)

- Straight

EtherNet/IP
PROFINET

Page 3.11.11



RJ45 male (shielded)

- Straight

EtherNet/IP
PROFINET

Page 3.11.12

EtherNet/IP



EtherCAT

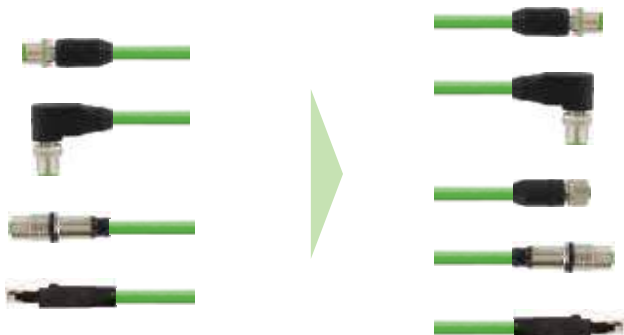

M12 male (shielded)

- Straight
- 90°

M12 female flange plug (shielded)

- Straight

RJ45 male (shielded)

- Straight

M12 male (shielded)

- Straight
- 90°

M12 female (shielded)

- Straight

M12 female flange plug (shielded)

- Straight

RJ45 male (shielded)

- Straight

Page 3.11.17

Power

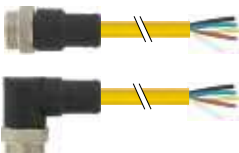

7/8" MINI male

- Straight
- 90°

Page 3.11.36

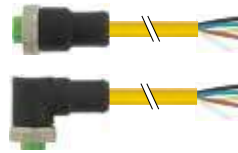

7/8" MINI female

- Straight
- 90°

Page 3.11.42

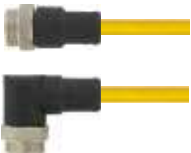

7/8" MINI male

- Straight
- 90°

7/8" MINI female

- Straight
- 90°

Page 3.11.48

TPE SERIES - THE NORTH AMERICAN STANDARD

With open ended wires M12

- ITC, PLTC cable
- Signal

Male
straight





Male
90°

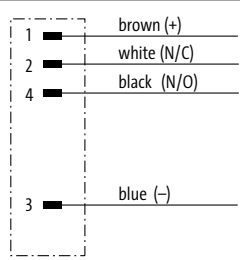

Approvals: 

* only for products with UL/CSA approved cable

1 Form		12021	12101
Type		4-pole	4-pole
Circuit diagram			
Contact layout	<p>Male</p> 		
2 Cable Type		Jacket Color	Jacket Color
Wire diameter 0.75 mm ²		yellow	yellow
TPE (UL/CSA), welding spark, C-tracks		150	150
3 Cable Length			
1.5 m		0150	
3.0 m		0300	
5.0 m		0500	
7.5 m		0750	
10.0 m		1000	
Technical Data			
Operating voltage		max. 250 V AC/DC	
Protection		IP65, IP66K, IP67 inserted and tightened (EN 60529)	
Temperature range		-25...+85 °C, depending on cable quality	
Article No.			
The composition of your article number is explained on page 3.1.i		<u>7 7 0 0</u> - - - - - - - - - -	- - - - -
		1 Form	2 Cable Type 3 Cable Length
Notes		Other versions on request. Differing cable lengths up to 2 m can be ordered in 0.2 m steps, from 2 m on in 0.5 m steps.	

TPE SERIES - THE NORTH AMERICAN STANDARD

With open ended wires M12

- ITC, PLTC cable

- Signal

Approvals: 

* only for products with UL/CSA approved cable

Male

straight



Male

90°

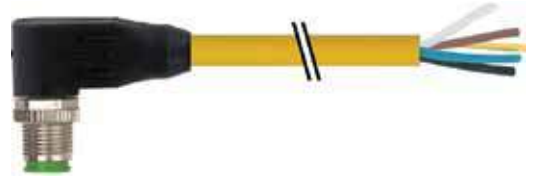

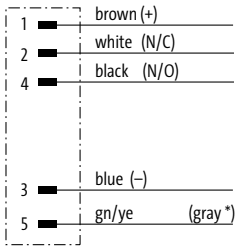
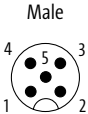
1 Form	12041	12121
	Type 5-pole	Type 5-pole
Circuit diagram	 <p>(* for cable type 162)</p>	
	Contact layout	
	<p>Male</p> 	
2 Cable Type	Jacket Color	Jacket Color
Wire diameter 0.75 mm ² TPE (UL/CSA), welding spark, C-tracks	yellow 161 (162)	yellow 161 (162)
3 Cable Length		
1.5 m	0150	
3.0 m	0300	
5.0 m	0500	
7.5 m	0750	
10.0 m	1000	
Technical Data		
Operating voltage	max. 125 V AC/DC	
Protection	IP65, IP66K, IP67 inserted and tightened (EN 60529)	
Temperature range	-25...+85 °C, depending on cable quality	
Article No.		
The composition of your article number is explained on page 3.1.i	<div style="display: flex; justify-content: space-around; align-items: center;"> <u>7</u> <u>7</u> <u>0</u> <u>0</u> - _____ - _____ - _____ </div>	
	1 Form	2 Cable Type
		3 Cable Length
Notes	Other versions on request. Differing cable lengths up to 2 m can be ordered in 0.2 m steps, from 2 m on in 0.5 m steps.	

TPE Series - The North American standard

TPE SERIES - THE NORTH AMERICAN STANDARD

With open ended wires M12

- ITC, PLTC cable
- Signal

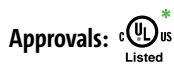

* only for products with UL/CSA approved cable

Female
straight



Female
90°



1 Form		12221	12341
Type	4-pole		4-pole
Circuit diagram			
Contact layout	Female 		
2 Cable Type		Jacket Color	
Wire diameter 0.75 mm ²	yellow		yellow
TPE (UL/CSA), welding spark, C-tracks	150		150
3 Cable Length			
1.5 m	0150		
3.0 m	0300		
5.0 m	0500		
7.5 m	0750		
10.0 m	1000		
Technical Data			
Operating voltage	max. 250 V AC/DC		
Protection	IP65, IP66K, IP67 inserted and tightened (EN 60529)		
Temperature range	-25...+85 °C, depending on cable quality		
Article No.			
The composition of your article number is explained on page 3.1.i	<div style="display: flex; justify-content: space-around; align-items: center;"> 7 7 0 0 - - </div>		
	1	2	3
	Form	Cable Type	Cable Length
Notes		Other versions on request. Differing cable lengths up to 2 m can be ordered in 0.2 m steps, from 2 m on in 0.5 m steps.	

TPE SERIES - THE NORTH AMERICAN STANDARD

With open ended wires M12

- ITC, PLTC cable

- Signal

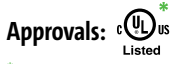

* only for products with UL/CSA approved cable

Female
straight



Female
90°

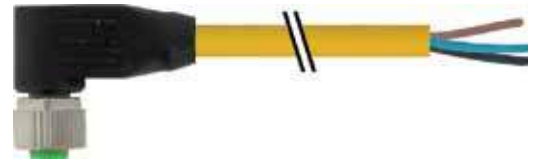

1 Form	Form	12241	12361
	Type	5-pole	5-pole
2 Cable Type	Circuit diagram		
	Contact layout	<p>Female</p>	
3 Cable Length	Wire diameter 0.75 mm ²	yellow	yellow
	TPE (UL/CSA), welding spark, C-tracks	161 (162)	161 (162)
Technical Data	1.5 m	0150	
	3.0 m	0300	
	5.0 m	0500	
	7.5 m	0750	
	10.0 m	1000	
Article No.	Operating voltage	max. 125 V AC/DC	
	Protection	IP65, IP66K, IP67 inserted and tightened (EN 60529)	
Notes	Temperature range	-25...+85 °C, depending on cable quality	
	The composition of your article number is explained on page 3.1.i	<div style="text-align: center;"> 7 7 0 0 - - - </div>	
		1 Form	2 Cable Type
			3 Cable Length
Other versions on request. Differing cable lengths up to 2 m can be ordered in 0.2 m steps, from 2 m on in 0.5 m steps.			

TPE SERIES - THE NORTH AMERICAN STANDARD

Connection cables M12 - M12

– ITC, PLTC cable

– Signal

Male

straight

Female

straight

Male

straight

Female

90°

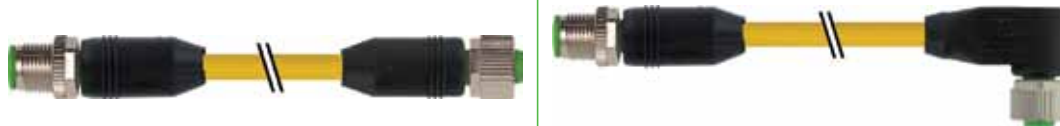

Approvals: 

* only for products with UL/CSA approved cable

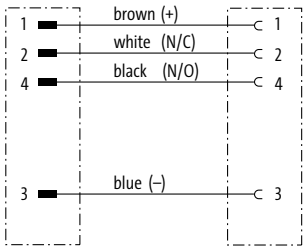
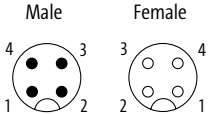
1 Form	40021	40121
Type	4-pole	4-pole
Circuit diagram		
Contact layout		
2 Cable Type	Jacket Color	Jacket Color
Wire diameter 0.75 mm ² TPE (UL/CSA), welding spark, C-tracks	yellow 150	yellow 150
3 Cable Length		
0.3 m	0030	
0.6 m	0060	
1.0 m	0100	
1.5 m	0150	
2.0 m	0200	
Technical Data		
Operating voltage	max. 250 V AC/DC	
Protection	IP65, IP66K, IP67 inserted and tightened (EN 60529)	
Temperature range	-25...+85 °C, depending on cable quality	
Article No.		
The composition of your article number is explained on page 3.1.i	<div style="display: flex; justify-content: space-around; align-items: center;"> 7 7 0 0 - - </div>	
	1 Form	2 Cable Type
		3 Cable Length
Notes	Other versions on request. Differing cable lengths up to 2 m can be ordered in 0.2 m steps, from 2 m on in 0.5 m steps.	

TPE SERIES - THE NORTH AMERICAN STANDARD

Connection cables M12 - M12

- ITC, PLTC cable
- Signal

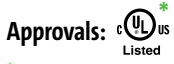

* only for products with UL/CSA approved cable



1 Form	4 0 2 0 1	4 0 2 6 1
	<p>Type: 4-pole</p> <p>Circuit diagram:</p>	4-pole
<p>Contact layout:</p>	<p>Male: 4, 3, 1, 2</p> <p>Female: 3, 4, 2, 1</p>	
2 Cable Type	Jacket Color	Jacket Color
<p>Wire diameter 0.75 mm²</p> <p>TPE (UL/CSA), welding spark, C-tracks</p>	<p>yellow</p> <p>150</p>	<p>yellow</p> <p>150</p>
3 Cable Length		
0.3 m	0030	
0.6 m	0060	
1.0 m	0100	
1.5 m	0150	
2.0 m	0200	
Technical Data		
Operating voltage	max. 250 V AC/DC	
Protection	IP65, IP66K, IP67 inserted and tightened (EN 60529)	
Temperature range	-25...+85 °C, depending on cable quality	
Article No.		
The composition of your article number is explained on page 3.1.i	<u>7</u> <u>7</u> <u>0</u> <u>0</u> - - - - - - - - - -	- - - - - - - - - -
	1 Form	2 Cable Type
		3 Cable Length
Notes	Other versions on request. Differing cable lengths up to 2 m can be ordered in 0.2 m steps, from 2 m on in 0.5 m steps.	

TPE Series - The North American standard

TPE SERIES - THE NORTH AMERICAN STANDARD

Connection cables M12 - M12

- ITC, PLTC cable
- Signal

Male
straight

Female
straight

Male
straight

Female
90°



Approvals: *

* only for products with UL/CSA approved cable

1 Form	40041	40141
Type	5-pole	5-pole
Circuit diagram	<p>(* for cable type 162)</p>	
Contact layout		
2 Cable Type	Jacket Color	Jacket Color
Wire diameter 0.75 mm ² TPE (UL/CSA), welding spark, C-tracks	yellow 161 (162)	yellow 161 (162)
3 Cable Length		
0.3 m	0030	
0.6 m	0060	
1.0 m	0100	
1.5 m	0150	
2.0 m	0200	
Technical Data		
Operating voltage	max. 125 V AC/DC	
Protection	IP65, IP66K, IP67 inserted and tightened (EN 60529)	
Temperature range	-25...+85 °C, depending on cable quality	
Article No.		
The composition of your article number is explained on page 3.1.i	<div style="display: flex; justify-content: space-around; align-items: center;"> 7 7 0 0 - - </div>	
	1 Form	2 Cable Type
		3 Cable Length
Notes	Other versions on request. Differing cable lengths up to 2 m can be ordered in 0.2 m steps, from 2 m on in 0.5 m steps.	

TPE SERIES - THE NORTH AMERICAN STANDARD

Connection cables M12 - M12

- ITC, PLTC cable

- Signal

Approvals: 

* only for products with UL/CSA approved cable



1 Form	4 0 2 2 1	4 0 2 8 1
	Type 5-pole	Type 5-pole
Circuit diagram	<p>(* for cable type 162)</p>	
Contact layout		
2 Cable Type	Jacket Color	Jacket Color
Wire diameter 0.75 mm ² TPE (UL/CSA), welding spark, Ctracks	yellow 161 (162)	yellow 161 (162)
3 Cable Length		
0.3 m	0030	
0.6 m	0060	
1.0 m	0100	
1.5 m	0150	
2.0 m	0200	
Technical Data		
Operating voltage	max. 125 V AC/DC	
Protection	IP65, IP66K, IP67 inserted and tightened (EN 60529)	
Temperature range	-25...+85 °C, depending on cable quality	
Article No.		
The composition of your article number is explained on page 3.1.i	<div style="display: flex; justify-content: space-around; align-items: center;"> 7 7 0 0 - - </div>	
	1 Form	2 Cable Type
		3 Cable Length
Notes	Other versions on request. Differing cable lengths up to 2 m can be ordered in 0.2 m steps, from 2 m on in 0.5 m steps.	

TPE Series - The North American standard

TPE SERIES - THE NORTH AMERICAN STANDARD

with open ended wires RJ45

– CMX-Outdoor

– Data

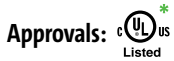

* only for products with UL/CSA approved cable

Male
straight
ITC, PLTC cable



Male
straight



1 Form		14541		14541	
Type	4-pole, shielded D-coded			4-pole, shielded D-coded	
Circuit diagram					
Contact layout	<p>Male</p>				
2 Cable Type		Jacket Color		Jacket Color	
2x2x0.34 mm ² TPE (UL/CSA), robots/C-tracks		green S7V		blue	
2x2x0.25 mm ² TPE (UL/CSA), robots/C-tracks				S4U	
3 Cable Length					
1.5 m	0150				
3.0 m	0300				
5.0 m	0500				
7.5 m	0750				
10.0 m	1000				
Technical Data					
Operating voltage	max. 60 V DC				
Protection	IP65, IP66K, IP67 inserted and tightened (EN 60529)				
Temperature range	-25...+85 °C, depending on cable quality				
Article No.					
The composition of your article number is explained on page 3.1.i		<u>7 7 0 0</u>	-	-	-
		1 Form	2 Cable Type	3 Cable Length	
Notes		Other versions on request. Differing cable lengths up to 2 m can be ordered in 0.2 m steps, from 2 m on in 0.5 m steps.			

TPE SERIES - THE NORTH AMERICAN STANDARD

with open ended wires RJ45

– CMX-Outdoor

– Data

PROFI® EtherNet/IP™
NET

Approvals:  ^{*}
Listed

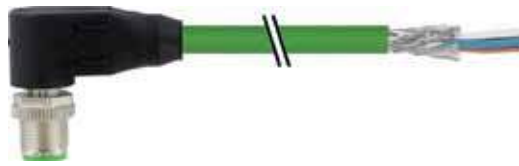

* only for products with UL/CSA approved cable

Male
90°
ITC, PLTC cable



Male
90°

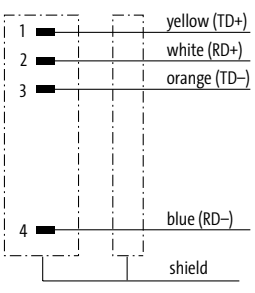
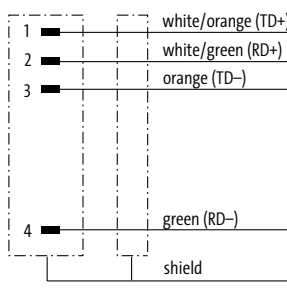

1 Form	14561	14561										
	<p>Type 4-pole, shielded D-coded</p> <p>Circuit diagram</p> 	<p>Type 4-pole, shielded D-coded</p> <p>Circuit diagram</p> 										
Contact layout	<p>Male</p> 											
2 Cable Type	Jacket Color	Jacket Color										
	<p>2x2x0.34 mm² TPE (UL/CSA), robots/C-tracks</p> <p>2x2x0.25 mm² TPE (UL/CSA), robots/C-tracks</p>	<p>green S7V</p>	<p>blue S4U</p>									
3 Cable Length	<table border="1"> <tr><td>1.5 m</td><td>0150</td></tr> <tr><td>3.0 m</td><td>0300</td></tr> <tr><td>5.0 m</td><td>0500</td></tr> <tr><td>7.5 m</td><td>0750</td></tr> <tr><td>10.0 m</td><td>1000</td></tr> </table>		1.5 m	0150	3.0 m	0300	5.0 m	0500	7.5 m	0750	10.0 m	1000
1.5 m	0150											
3.0 m	0300											
5.0 m	0500											
7.5 m	0750											
10.0 m	1000											
Technical Data	<p>Operating voltage: max. 60 V DC</p> <p>Protection: IP65, IP66K, IP67 inserted and tightened (EN 60529)</p> <p>Temperature range: -25...+85 °C, depending on cable quality</p>											
Article No.	<p>The composition of your article number is explained on page 3.1.i</p> <p><u>7</u> <u>7</u> <u>0</u> <u>0</u> - - - - -</p>											
	1 Form	2 Cable Type										
		3 Cable Length										
Notes	<p>Other versions on request. Differing cable lengths up to 2 m can be ordered in 0.2 m steps, from 2 m on in 0.5 m steps.</p>											

TPE SERIES - THE NORTH AMERICAN STANDARD

with open ended wires RJ45

– CMX-Outdoor

– Data

PROFI® EtherNet/IP™
NET

Approvals: 



Flange female

ITC, PLTC cable



Flange female

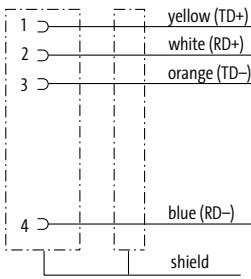
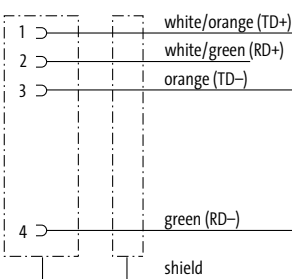

1 Form	14511	14511
Type	4-pole, shielded D-coded Rear mounting	4-pole, shielded D-coded Rear mounting
Circuit diagram		
Contact layout	Female 	
2 Cable Type	Jacket Color	Jacket Color
2×2×0.34 mm ² TPE (UL/CSA), robots/C-tracks	green S7V	blue
2×2×0.25 mm ² TPE (UL/CSA), robots/C-tracks		S4U
3 Cable Length		
1.5 m	0150	
3.0 m	0300	
5.0 m	0500	
7.5 m	0750	
10.0 m	1000	
Technical Data		
Operating voltage	max. 60 V DC	
Protection	IP67 inserted and tightened (EN 60529)	
Temperature range	-25...+85 °C, depending on cable quality	
Article No.		
The composition of your article number is explained on page 3.1.i	7 7 0 0 - - - - -	- - - - -
	1 Form	2 Cable Type
		3 Cable Length
Notes	Other versions on request. Differing cable lengths up to 2 m can be ordered in 0.2 m steps, from 2 m on in 0.5 m steps.	

TPE SERIES - THE NORTH AMERICAN STANDARD

with open ended wires RJ45

– CMX-Outdoor

– Data

PROFI® EtherNet/IP™
NET

Approvals:  ^{*}
Listed



* only for products with UL/CSA approved cable

Male
straight
ITC, PLTC cable



Male
straight

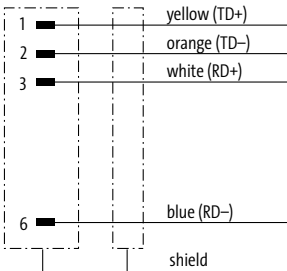
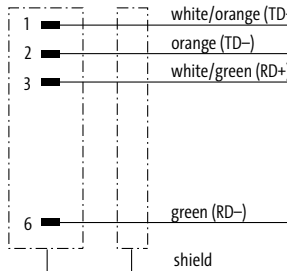

1 Form		74101	74101
Type	4-pole, shielded		4-pole, shielded
Circuit diagram			
Contact layout	<p>Male</p> 		
2 Cable Type		Jacket Color	Jacket Color
2x2x0.34 mm ² TPE (UL/CSA), robots/C-tracks	green	57V	blue
2x2x0.25 mm ² TPE (UL/CSA), robots/C-tracks			S4U
3 Cable Length			
1.5 m	0150		
3.0 m	0300		
5.0 m	0500		
7.5 m	0750		
10.0 m	1000		
Technical Data			
Operating voltage	max. 60 V DC		
Protection	IP20 inserted and tightened (EN 60529)		
Temperature range	-25...+85 °C, depending on cable quality		
Article No.			
The composition of your article number is explained on page 3.1.i	<div style="display: flex; align-items: center; justify-content: center;"> 7 7 0 0 - - - </div>		
	1	2	3
	Form	Cable Type	Cable Length
Notes			
Other versions on request. Differing cable lengths up to 2 m can be ordered in 0.2 m steps, from 2 m on in 0.5 m steps.			

TPE Series - The North American standard

TPE SERIES - THE NORTH AMERICAN STANDARD

With open ended wires M12

– CMX-Outdoor

– Data



Male
straight



Male
90°



1 Form	17541	17561
Type	8-pole, shielded	8-pole, shielded
Circuit diagram		
Contact layout		
2 Cable Type	Jacket Color	Jacket Color
4x2x0.25 mm ² TPE (UL/CSA), robots/C-tracks	blue S4W	blue S4W
3 Cable Length		
1.5 m	0150	
3.0 m	0300	
5.0 m	0500	
7.5 m	0750	
10.0 m	1000	
Technical Data		
Operating voltage	max. 60 V AC/DC	
Protection	IP65, IP66K, IP67 inserted and tightened (EN 60529)	
Temperature range	-25...+85 °C, depending on cable quality	
Article No.		
The composition of your article number is explained on page 3.1.i	<div style="display: flex; justify-content: space-around; align-items: center;"> 7 7 0 0 - - </div>	
	1 Form	2 Cable Type
		3 Cable Length
Notes	Other versions on request. Differing cable lengths up to 2 m can be ordered in 0.2 m steps, from 2 m on in 0.5 m steps.	

TPE SERIES - THE NORTH AMERICAN STANDARD

With open ended wires M12

– CMX-Outdoor

– Data

PROFI® EtherNet/IP™
NET

Female
straight



1 Form	17581	
Type	8-pole, shielded	
Circuit diagram		
Contact layout	<p>Female</p>	
2 Cable Type	Jacket Color	
4×2×0.25 mm ² TPE (UL/CSA), robots/C-tracks	blue	S4W
3 Cable Length		
1.5 m	0150	
3.0 m	0300	
5.0 m	0500	
7.5 m	0750	
10.0 m	1000	
Technical Data		
Operating voltage	max. 60 V AC/DC	
Protection	IP65, IP66K, IP67 inserted and tightened (EN 60529)	
Temperature range	-25...+85 °C, depending on cable quality	
Article No.		
The composition of your article number is explained on page 3.1.i	<p><u>7 7 0 0</u> - <u>1 7 5 8 1</u> - _ _ _ _</p>	
	1 Form	2 Cable Type
		3 Cable Length
Notes	Other versions on request. Differing cable lengths up to 2 m can be ordered in 0.2 m steps, from 2 m on in 0.5 m steps.	

TPE SERIES - THE NORTH AMERICAN STANDARD

With open ended wires M12

– CMX-Outdoor

– Data



Flange female



1 Form		17511	
Type	8-pole, shielded Rear mounting		
Circuit diagram			
Contact layout	Female 		
2 Cable Type		Jacket Color	
4x2x0.25 mm ² TPE (UL/CSA), robots/Ctracks	blue S4W		
3 Cable Length			
1.5 m	0150		
3.0 m	0300		
5.0 m	0500		
7.5 m	0750		
10.0 m	1000		
Technical Data			
Operating voltage	max. 60 V AC/DC		
Protection	IP67 inserted and tightened (EN 60529)		
Temperature range	-25...+85 °C, depending on cable quality		
Article No.			
The composition of your article number is explained on page 3.1.i	7 7 0 0 - 1 7 5 1 1 - _ _ _ _		
	1 Form	2 Cable Type	3 Cable Length
Notes			
Other versions on request. Differing cable lengths up to 2 m can be ordered in 0.2 m steps, from 2 m on in 0.5 m steps.			

TPE SERIES - THE NORTH AMERICAN STANDARD

with open ended wires RJ45

– CMX-Outdoor

– Data



Male
straight



1 Form		74118	
Type	8-pole, shielded		
Circuit diagram			
Contact layout	<p>Male</p>		
2 Cable Type		Jacket Color	
4x2x0.25 mm ² TPE (UL/CSA), robots/C-tracks	<p>blue</p> <p>S4W</p>		
3 Cable Length			
1.5 m	0150		
3.0 m	0300		
5.0 m	0500		
7.5 m	0750		
10.0 m	1000		
Technical Data			
Operating voltage	max. 60 V DC		
Protection	IP20 inserted and tightened (EN 60529)		
Temperature range	-25...+85 °C, depending on cable quality		
Article No.			
The composition of your article number is explained on page 3.1.i	<p><u>7 7 0 0</u> - <u>7 4 1 1 8</u> - _ _ _ _</p>		
	1 Form	2 Cable Type	3 Cable Length
Notes		Other versions on request. Differing cable lengths up to 2 m can be ordered in 0.2 m steps, from 2 m on in 0.5 m steps.	

TPE Series - The North American standard

TPE SERIES - THE NORTH AMERICAN STANDARD

Connection cables M12 - M12

– CMX-Outdoor

– Data

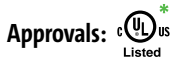

* only for products with UL/CSA approved cable

Male
straight
ITC, PLTC cable

Male
straight

Male
straight

Male
straight



1 Form		4 4 5 1 1		4 4 5 1 1	
Type	4-pole, shielded D-coded			4-pole, shielded D-coded	
Circuit diagram					
Contact layout					
2 Cable Type		Jacket Color		Jacket Color	
2x2x0.34 mm ² TPE (UL/CSA), robots/C-tracks		green		blue	
2x2x0.25 mm ² TPE (UL/CSA), robots/C-tracks		S7V		S4U	
3 Cable Length					
1.5 m	0150				
3.0 m	0300				
5.0 m	0500				
7.5 m	0750				
10.0 m	1000				
Technical Data					
Operating voltage	max. 60 V DC				
Protection	IP65, IP66K, IP67 inserted and tightened (EN 60529)				
Temperature range	-25...+85 °C, depending on cable quality				
Article No.					
The composition of your article number is explained on page 3.1.i		7 7 0 0	-	-	-
		1	Form	2	Cable Type
		3	Cable Length		
Notes	Other versions on request. Differing cable lengths up to 2 m can be ordered in 0.2 m steps, from 2 m on in 0.5 m steps.				

TPE SERIES - THE NORTH AMERICAN STANDARD

Connection cables M12 - M12

– CMX-Outdoor

– Data

PROFI® EtherNet/IP™
NET

Approvals:  ^{*}
Listed

* only for products with UL/CSA approved cable

Male
straight
ITC, PLTC cable

Male
90°



Male
straight

Male
90°

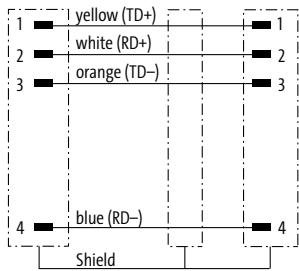
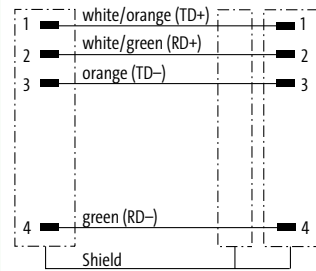
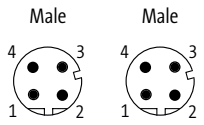
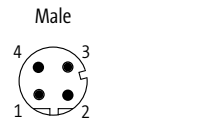

1 Form	4 4 5 4 1	4 4 5 4 1
	<p>Type</p> <p>4-pole, shielded</p> <p>D-coded</p>	<p>Type</p> <p>4-pole, shielded</p> <p>D-coded</p>
Circuit diagram		
Contact layout	<p>Male</p> 	<p>Male</p> 
2 Cable Type	Jacket Color	Jacket Color
	<p>2x2x0.34 mm² TPE (UL/CSA), robots/C-tracks</p> <p>2x2x0.25 mm² TPE (UL/CSA), robots/C-tracks</p>	<p>green</p> <p>S7V</p>
3 Cable Length	<p>1.5 m 0150</p> <p>3.0 m 0300</p> <p>5.0 m 0500</p> <p>7.5 m 0750</p> <p>10.0 m 1000</p>	
Technical Data	<p>Operating voltage max. 60 V DC</p> <p>Protection IP65, IP66K, IP67 inserted and tightened (EN 60529)</p> <p>Temperature range -25...+85 °C, depending on cable quality</p>	
Article No.	<p>The composition of your article number is explained on page 3.1.i</p> <p>7 7 0 0 - - - - -</p>	
	1 Form	2 Cable Type
		3 Cable Length
Notes	<p>Other versions on request. Differing cable lengths up to 2 m can be ordered in 0.2 m steps, from 2 m on in 0.5 m steps.</p>	

TPE Series - The North American standard

TPE SERIES - THE NORTH AMERICAN STANDARD

Connection cables M12 - M12

– CMX-Outdoor

– Data

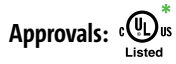

* only for products with UL/CSA approved cable

Male

90°
ITC, PLTC cable

Male

90°

Male

90°

Male

90°



1 Form

4 4 5 6 1

4 4 5 6 1

Type

4-pole, shielded

4-pole, shielded

Circuit diagram

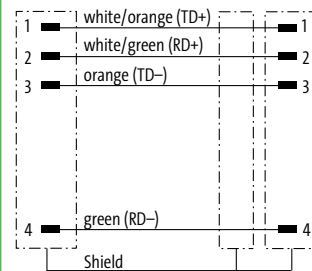
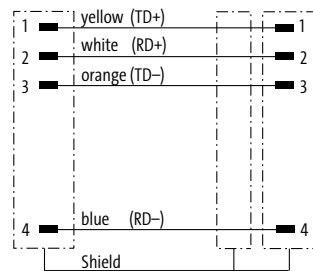

Contact layout

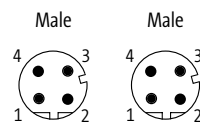

2 Cable Type

Jacket Color

Jacket Color

2x2x0.34 mm²
TPE (UL/CSA), robots/C-tracks

green
S7V

blue

2x2x0.25 mm²
TPE (UL/CSA), robots/C-tracks

S4U

3 Cable Length

1.5 m	0150
3.0 m	0300
5.0 m	0500
7.5 m	0750
10.0 m	1000

Technical Data

Operating voltage	max. 60 V DC
Protection	IP65, IP66K, IP67 inserted and tightened (EN 60529)
Temperature range	-25...+85 °C, depending on cable quality

Article No.

The composition of your article number is explained on page 3.1.i

7 7 0 0 - - - - -

1 Form

2 Cable Type

3 Cable Length

Notes

Other versions on request. Differing cable lengths up to 2 m can be ordered in 0.2 m steps, from 2 m on in 0.5 m steps.

TPE SERIES - THE NORTH AMERICAN STANDARD

Connection cables M12 - M12

– CMX-Outdoor

– Data

PROFI® EtherNet/IP™
NET

Approvals:  ^{*}
Listed

* only for products with UL/CSA approved cable

Male
straight
ITC, PLTC cable

Female
straight

Male
straight

Female
straight



1 Form

4 4 5 7 1

4 4 5 7 1

Type

4-pole, shielded

4-pole, shielded

Circuit diagram

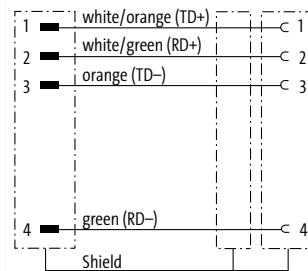
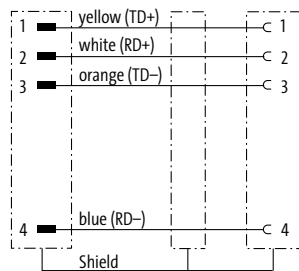

Contact layout

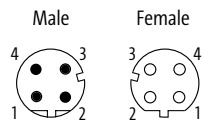

2 Cable Type

Jacket Color

Jacket Color

2x2x0.34 mm²
TPE (UL/CSA), robots/C-tracks
2x2x0.25 mm²
TPE (UL/CSA), robots/C-tracks

green
S7V

blue
S4U

3 Cable Length

1.5 m **0150**
3.0 m **0300**
5.0 m **0500**
7.5 m **0750**
10.0 m **1000**

Technical Data

Operating voltage max. 60 V DC
Protection IP65, IP66K, IP67 inserted and tightened (EN 60529)
Temperature range -25...+85 °C, depending on cable quality

Article No.

The composition of your article number is explained on page 3.1.i

7 7 0 0 - - - - -

1 Form

2 Cable Type

3 Cable Length

Notes

Other versions on request. Differing cable lengths up to 2 m can be ordered in 0.2 m steps, from 2 m on in 0.5 m steps.

TPE SERIES - THE NORTH AMERICAN STANDARD

Connection cables M12 - M12

– CMX-Outdoor

– Data

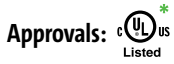

* only for products with UL/CSA approved cable

Male

straight
ITC, PLTC cable

Flange female

Male

straight

Flange female



1 Form		4 4 8 1 1		4 4 8 1 1	
Type	4-pole, shielded	D-coded		D-coded	
	Rear mounting	Rear mounting		Rear mounting	
Circuit diagram					
Contact layout					
2 Cable Type		Jacket Color		Jacket Color	
2x2x0.34 mm ²	TPE (UL/CSA), robots/C-tracks	green	S7V	blue	
2x2x0.25 mm ²	TPE (UL/CSA), robots/C-tracks			S4U	
3 Cable Length					
1.5 m	0150				
3.0 m	0300				
5.0 m	0500				
7.5 m	0750				
10.0 m	1000				
Technical Data					
Operating voltage	max. 60 V DC				
Protection	IP67 inserted and tightened (EN 60529)				
Temperature range	-25...+85 °C, depending on cable quality				
Article No.					
The composition of your article number is explained on page 3.1.i		7 7 0 0 - - - - -		- - - - -	
		1 Form		2 Cable Type	
				3 Cable Length	
Notes					
		Other versions on request. Differing cable lengths up to 2 m can be ordered in 0.2 m steps, from 2 m on in 0.5 m steps.			

TPE SERIES - THE NORTH AMERICAN STANDARD

Connection cables M12 - RJ45

– CMX-Outdoor

– Data

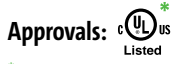

* only for products with UL/CSA approved cable

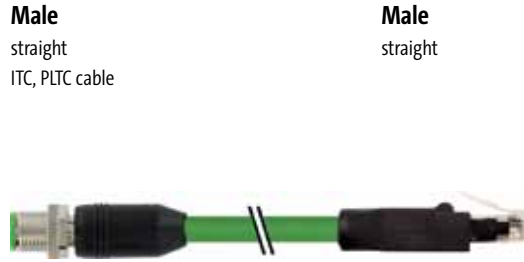

1 Form	4 4 7 1 1	4 4 7 1 1	
	<p>Type</p> <p>4-pole, shielded</p> <p>D-coded</p>	<p>Type</p> <p>4-pole, shielded</p> <p>D-coded</p>	
Circuit diagram			
	<p>Contact layout</p>		
2 Cable Type	Jacket Color	Jacket Color	
	<p>2x2x0.34 mm² TPE (UL/CSA), robots/C-tracks</p> <p>2x2x0.25 mm² TPE (UL/CSA), robots/C-tracks</p>	<p>green</p> <p>S7V</p>	<p>blue</p> <p>S4U</p>
3 Cable Length	1.5 m	0150	
	3.0 m	0300	
	5.0 m	0500	
	7.5 m	0750	
	10.0 m	1000	
Technical Data	Operating voltage	max. 60 V DC	
	Protection	IP67 (M12) - IP20 (RJ45)	
	Temperature range	-25...+85 °C, depending on cable quality	
Article No.	<p>The composition of your article number is explained on page 3.1.i</p> <p><u>7 7 0 0</u> - - - - -</p>		
	1 Form	2 Cable Type	3 Cable Length
Notes	Other versions on request. Differing cable lengths up to 2 m can be ordered in 0.2 m steps, from 2 m on in 0.5 m steps.		

TPE Series - The North American standard

TPE SERIES - THE NORTH AMERICAN STANDARD

Connection cables M12 - RJ45

– CMX-Outdoor

– Data

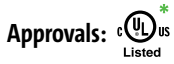

* only for products with UL/CSA approved cable

Male

90°
ITC, PLTC cable



Male

straight

Male

90°



Male

straight

1 Form		44761		44761	
Type	4-pole, shielded D-coded			4-pole, shielded D-coded	
Circuit diagram					
Contact layout					
2 Cable Type		Jacket Color		Jacket Color	
2x2x0.34 mm ² TPE (UL/CSA), robots/C-tracks		green		blue	
2x2x0.25 mm ² TPE (UL/CSA), robots/C-tracks		S7V		S4U	
3 Cable Length					
1.5 m	0150				
3.0 m	0300				
5.0 m	0500				
7.5 m	0750				
10.0 m	1000				
Technical Data					
Operating voltage	max. 60 V DC				
Protection	IP67 (M12) - IP20 (RJ45)				
Temperature range	-25...+85 °C, depending on cable quality				
Article No.					
The composition of your article number is explained on page 3.1.i		<u>7</u> <u>7</u> <u>0</u> <u>0</u>	-	-	-
		1 Form	2 Cable Type	3 Cable Length	
Notes		Other versions on request. Differing cable lengths up to 2 m can be ordered in 0.2 m steps, from 2 m on in 0.5 m steps.			

TPE SERIES - THE NORTH AMERICAN STANDARD

Connection cables M12 - RJ45

– CMX-Outdoor

– Data

PROFI® EtherNet/IP™
NET

Approvals: 

* only for products with UL/CSA approved cable

Flange female

ITC, PLTC cable

Male

straight



Flange female

Male

straight



1 Form

4 4 8 5 1

4 4 8 5 1

Type

4-pole, shielded

4-pole, shielded

Circuit diagram

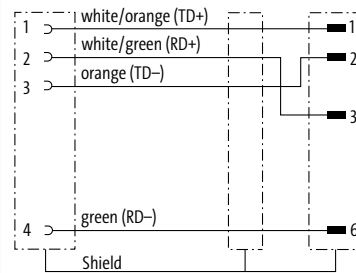
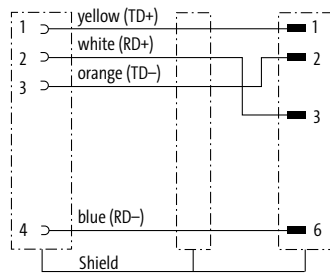

Contact layout

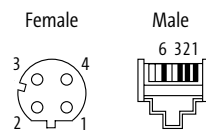

2 Cable Type

Jacket Color

Jacket Color

2x2x0.34 mm²
TPE (UL/CSA), robots/C-tracks

green
S7V

blue

2x2x0.25 mm²
TPE (UL/CSA), robots/C-tracks

S4U

3 Cable Length

1.5 m **0150**
3.0 m **0300**
5.0 m **0500**
7.5 m **0750**
10.0 m **1000**

Technical Data

Operating voltage max. 60 V DC
Protection IP67 (M12) - IP20 (RJ45)
Temperature range -25...+85 °C, depending on cable quality

Article No.

The composition of your article number is explained on page 3.1.i

7 7 0 0 - - - - -

1 Form

2 Cable Type

3 Cable Length

Notes

Other versions on request. Differing cable lengths up to 2 m can be ordered in 0.2 m steps, from 2 m on in 0.5 m steps.

TPE SERIES - THE NORTH AMERICAN STANDARD

Connection cables RJ45 - RJ45

– CMX-Outdoor

– Data

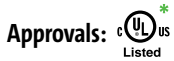

* only for products with UL/CSA approved cable

Male

straight
ITC, PLTC cable

Male

straight

Male

straight

Male

straight



1 Form		74301	74301
Type	4-pole, shielded	4-pole, shielded	4-pole, shielded
Circuit diagram			
Contact layout			
2 Cable Type	Jacket Color		Jacket Color
2x2x0.34 mm ² TPE (UL/CSA), robots/C-tracks	green S7V		blue
2x2x0.25 mm ² TPE (UL/CSA), robots/C-tracks			S4U
3 Cable Length			
1.5 m	0150		
3.0 m	0300		
5.0 m	0500		
7.5 m	0750		
10.0 m	1000		
Technical Data			
Operating voltage	max. 60 V DC		
Protection	IP20 inserted and tightened (EN 60529)		
Temperature range	-25...+85 °C, depending on cable quality		
Article No.			
The composition of your article number is explained on page 3.1.i	7 7 0 0 - - - - -		
	1 Form	2 Cable Type	3 Cable Length
Notes	Other versions on request. Differing cable lengths up to 2 m can be ordered in 0.2 m steps, from 2 m on in 0.5 m steps.		

TPE SERIES - THE NORTH AMERICAN STANDARD

Connection cables M12 - M12

– CMX-Outdoor

– Data

PROFI® EtherNet/IP™
NET

Male
straight

Male
straight

Male
straight

Male
90°



1 Form

48511

48541

Type

8-pole, shielded

8-pole, shielded

Circuit diagram

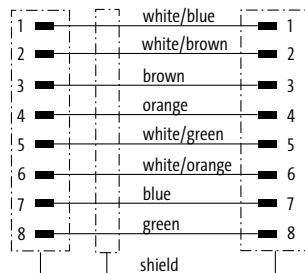

Contact layout

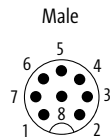

2 Cable Type

Jacket Color

Jacket Color

4x2x0.25 mm²
TPE (UL/CSA), robots/C-tracks

blue
S4W

blue
S4W

3 Cable Length

1.5 m	0150
3.0 m	0300
5.0 m	0500
7.5 m	0750
10.0 m	1000

Technical Data

Operating voltage	max. 60 V AC/DC
Protection	IP65 and IP67 when plugged and screwed down (EN 60529)
Temperature range	-25...+85 °C, depending on cable quality

Article No.

The composition of your article number is explained on page 3.1.i

7 7 0 0 - - - - -

1 Form

2 Cable Type

3 Cable Length

Notes

Other versions on request. Differing cable lengths up to 2 m can be ordered in 0.2 m steps, from 2 m on in 0.5 m steps.

TPE SERIES - THE NORTH AMERICAN STANDARD

Connection cables M12 - M12

– CMX-Outdoor

– Data

PROFI® EtherNet/IP™
NET

Male
90°

Male
90°



1 Form **48561**

Type **8-pole, shielded**

Circuit diagram

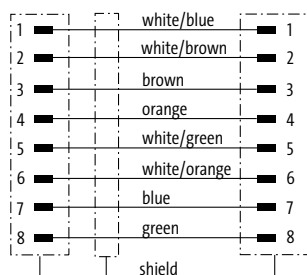

Contact layout

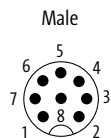

2 Cable Type **Jacket Color**

4x2x0.25 mm²

TPE (UL/CSA), robots/C-tracks

blue

S4W

3 Cable Length

1.5 m

0150

3.0 m

0300

5.0 m

0500

7.5 m

0750

10.0 m

1000

Technical Data

Operating voltage

max. 60 V AC/DC

Protection

IP65 and IP67 when plugged and screwed down (EN 60529)

Temperature range

-25...+85 °C, depending on cable quality

Article No.

The composition of your article number is explained on page 3.1.i

7 7 0 0

-

4 8 5 6 1

-

1 Form

2 Cable Type

3 Cable Length

Notes

Other versions on request. Differing cable lengths up to 2 m can be ordered in 0.2 m steps, from 2 m on in 0.5 m steps.

TPE SERIES - THE NORTH AMERICAN STANDARD

Connection cables M12 - M12

– CMX-Outdoor

– Data

PROFI® EtherNet/IP™
NET

Male

straight

Female

straight



1 Form	48571	
Type	8-pole, shielded	
Circuit diagram		
Contact layout		
2 Cable Type	Jacket Color	
4x2x0.25 mm ² TPE (UL/CSA), robots/C-tracks	<div style="background-color: #00a0e3; color: white; padding: 2px;">blue</div> <div style="background-color: #00a0e3; color: white; padding: 2px;">S4W</div>	
3 Cable Length		
1.5 m	0150	
3.0 m	0300	
5.0 m	0500	
7.5 m	0750	
10.0 m	1000	
Technical Data		
Operating voltage	max. 60 V AC/DC	
Protection	IP65 and IP67 when plugged and screwed down (EN 60529)	
Temperature range	-25...+85 °C, depending on cable quality	
Article No.		
The composition of your article number is explained on page 3.1.i	<div style="display: flex; justify-content: space-around; align-items: center;"> <div style="border: 1px solid black; padding: 2px;">7</div> <div style="border: 1px solid black; padding: 2px;">7</div> <div style="border: 1px solid black; padding: 2px;">0</div> <div style="border: 1px solid black; padding: 2px;">0</div> - <div style="border: 1px solid black; padding: 2px;">4</div> <div style="border: 1px solid black; padding: 2px;">8</div> <div style="border: 1px solid black; padding: 2px;">5</div> <div style="border: 1px solid black; padding: 2px;">7</div> <div style="border: 1px solid black; padding: 2px;">1</div> - <div style="border: 1px solid black; padding: 2px;">_</div> <div style="border: 1px solid black; padding: 2px;">_</div> <div style="border: 1px solid black; padding: 2px;">_</div> <div style="border: 1px solid black; padding: 2px;">_</div> </div>	
	1 Form	2 Cable Type
		3 Cable Length
Notes	Other versions on request. Differing cable lengths up to 2 m can be ordered in 0.2 m steps, from 2 m on in 0.5 m steps.	

TPE Series - The North American standard

TPE SERIES - THE NORTH AMERICAN STANDARD

Connection cables M12 - M12

– CMX-Outdoor

– Data

PROFI EtherNet/IP
NET

Male
straight

Male
straight

Male
90°

Male
straight



1 Form	48521	48551
---------------	--------------	--------------

Type	8-pole, shielded	8-pole, shielded
------	------------------	------------------

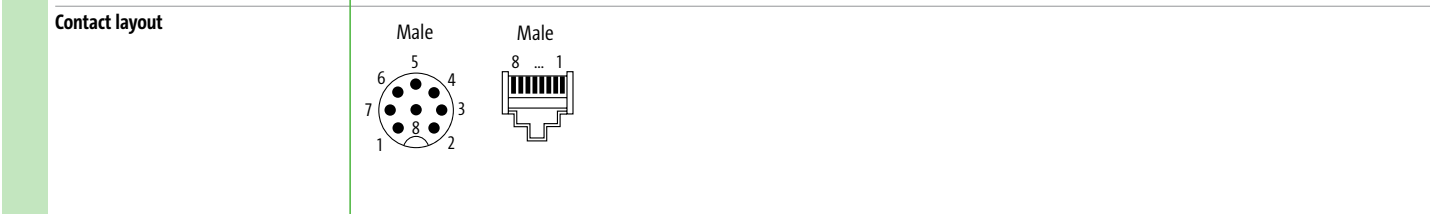
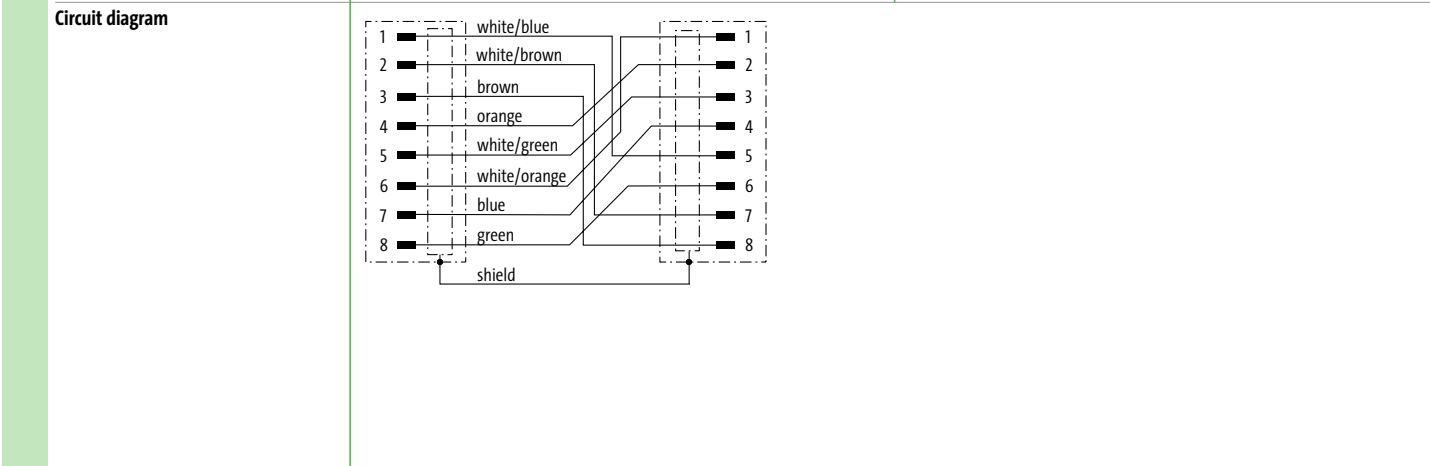

2 Cable Type	Jacket Color	Jacket Color
---------------------	---------------------	---------------------

4x2x0.25 mm ² TPE (UL/CSA), robots/C-tracks	blue S4W	blue S4W
---	-------------	-------------

3 Cable Length	
-----------------------	--

1.5 m	0150
3.0 m	0300
5.0 m	0500
7.5 m	0750
10.0 m	1000

Technical Data	
-----------------------	--

Operating voltage	max. 30 V AC/DC
Protection	IP67 (M12) - IP20 (RJ45)
Temperature range	-25...+85 °C, depending on cable quality

Article No.	
--------------------	--

The composition of your article number is explained on page 3.1.i

7	7	0	0	-	-	-	-
----------	----------	----------	----------	---	---	---	---

1 Form	2 Cable Type	3 Cable Length
---------------	---------------------	-----------------------

Notes

Other versions on request. Differing cable lengths up to 2 m can be ordered in 0.2 m steps, from 2 m on in 0.5 m steps.

TPE SERIES - THE NORTH AMERICAN STANDARD

Connection cables M12 - M12

– CMX-Outdoor

– Data



Flange female

Male
straight



1 Form	48851	
Type	8-pole, shielded Rear mounting	
Circuit diagram		
Contact layout		
2 Cable Type	Jacket Color	
4x2x0.25 mm ² TPE (UL/CSA), robots/C-tracks	<div style="background-color: #00a0e3; color: white; padding: 2px;">blue</div> <div style="background-color: #00a0e3; color: white; padding: 2px;">S4W</div>	
3 Cable Length		
1.5 m	0150	
3.0 m	0300	
5.0 m	0500	
7.5 m	0750	
10.0 m	1000	
Technical Data		
Operating voltage	max. 30 V AC/DC	
Protection	IP67 (M12) - IP20 (RJ45)	
Temperature range	-25...+85 °C, depending on cable quality	
Article No.		
The composition of your article number is explained on page 3.1.i	<div style="display: flex; align-items: center; justify-content: center; gap: 10px;"> 7 7 0 0 - 4 8 8 5 1 - _ _ _ </div>	
	1 Form	2 Cable Type
		3 Cable Length
Notes	Other versions on request. Differing cable lengths up to 2 m can be ordered in 0.2 m steps, from 2 m on in 0.5 m steps.	

TPE Series - The North American standard

TPE SERIES - THE NORTH AMERICAN STANDARD

Connection cables RJ45 - RJ45

– CMX-Outdoor

– Data



Male

straight

Male

straight



1 Form 74718

Type 8-pole, shielded

Circuit diagram	
1	white/orange
2	orange
3	white/green
4	green
5	white/brown
6	brown
7	white/blue
8	blue
shield	

Contact layout	
Male	

2 Cable Type Jacket Color

4x2x0.25 mm ²	blue
TPE (UL/CSA), robots/Ctracks	S4W

3 Cable Length

1.5 m	0150
3.0 m	0300
5.0 m	0500
7.5 m	0750
10.0 m	1000

Technical Data

Operating voltage	max. 60 V DC
Protection	IP20 inserted and tightened (EN 60529)
Temperature range	-25...+85 °C, depending on cable quality

Article No.

The composition of your article number is explained on page 3.1.i	7 7 0 0 - 7 4 7 1 8 - _____
	1 Form 2 Cable Type 3 Cable Length

Notes

Other versions on request. Differing cable lengths up to 2 m can be ordered in 0.2 m steps, from 2 m on in 0.5 m steps.

TPE SERIES - THE NORTH AMERICAN STANDARD

Connection cables M12 - M12

– CMX-Outdoor

– Data

– X-coded



* only for products with UL/CSA approved cable

Male
straight

Male
straight

Male
straight

Male
90°



1 Form	510 01	51011
Approvals	cULus *	
Type	8-pole, shielded X-coded	8-pole, shielded X-coded
Circuit diagram		
Contact layout		
2 Cable Type	Jacket Color	Jacket Color
4x2x0.14 mm ² TPE (UL/CSA), robots/C-tracks	blue S4X	blue S4X
3 Cable Length		
1.5 m	0150	
3.0 m	0300	
5.0 m	0500	
7.5 m	0750	
10.0 m	1000	
Technical Data		
Operating voltage	max. 50 V AC/60 V DC	
Protection	IP67 inserted and tightened (EN 60529)	
Temperature range	-25...+85 °C, depending on cable quality	
Article No.		
The composition of your article number is explained on page 3.1.i	<div style="display: flex; justify-content: space-around; align-items: center;"> 7 7 0 0 - - </div>	
	1 Form	2 Cable Type
		3 Cable Length
Notes	Other versions on request. Differing cable lengths up to 2 m can be ordered in 0.2 m steps, from 2 m on in 0.5 m steps.	

TPE SERIES - THE NORTH AMERICAN STANDARD

Connection cables M12 - M12

– CMX-Outdoor

– Data

– X-coded

PROFI® EtherNet/IP™
NET

Male
90°

Male
90°



1 Form	51021	
Type	8-pole, shielded X-coded	
Circuit diagram		
Contact layout		
2 Cable Type	Jacket Color	
4x2x0.14 mm ² TPE (UL/CSA), robots/Ctracks	blue S4X	
3 Cable Length		
1.5 m		0150
3.0 m		0300
5.0 m		0500
7.5 m		0750
10.0 m		1000
Technical Data		
Operating voltage	max. 50 V AC/60 V DC	
Protection	IP67 inserted and tightened (EN 60529)	
Temperature range	-25...+85 °C, depending on cable quality	
Article No.		
The composition of your article number is explained on page 3.1.i	<div style="display: flex; justify-content: space-around; align-items: center;"> <u>7</u> <u>7</u> <u>0</u> <u>0</u> - <u>5</u> <u>1</u> <u>0</u> <u>2</u> <u>1</u> - </div>	
	1 Form	2 Cable Type
		3 Cable Length
Notes	Other versions on request. Differing cable lengths up to 2 m can be ordered in 0.2 m steps, from 2 m on in 0.5 m steps.	

TPE SERIES - THE NORTH AMERICAN STANDARD

Connection cables M12 - RJ45

– CMX-Outdoor

– Data

– X-coded



Male
straight

Male
straight

Male
90°

Male
straight



1 Form	51101	51201	
	8-pole, shielded	8-pole, shielded	
Type			
Circuit diagram			
Contact layout			
2 Cable Type	Jacket Color	Jacket Color	Jacket Color
4x2x0.14 mm ² TPE (UL/CSA), robots/C-tracks	blue S4X	blue S4X	blue S4X
3 Cable Length			
1.5 m	0150		
3.0 m	0300		
5.0 m	0500		
7.5 m	0750		
10.0 m	1000		
Technical Data			
Operating voltage	max. 60 V DC		
Protection	IP66K, IP67 (M12) - IP20 (RJ45)		
Temperature range	-25...+85 °C, depending on cable quality		
Article No.			
The composition of your article number is explained on page 3.1.i	<div style="display: flex; justify-content: space-around; align-items: center;"> 7 7 0 0 - - </div>		
	1 Form	2 Cable Type	3 Cable Length
Notes	Other versions on request. Differing cable lengths up to 2 m can be ordered in 0.2 m steps, from 2 m on in 0.5 m steps.		

TPE Series - The North American standard

TPE SERIES - THE NORTH AMERICAN STANDARD

Connection cables RJ45 - RJ45

– CMX-Outdoor

– Data

– X-coded



Male
straight

Male
straight

Male
straight

Flange female



1 Form	74315	51551
	Type 8-pole, shielded	Type 8-pole, shielded Rear mounting
Circuit diagram		
Contact layout	<p>Male</p>	<p>Male</p> <p>Female</p>
2 Cable Type	Jacket Color	Jacket Color
4x2x0.14 mm ² TPE (UL/CSA), robots/Ctracks	blue S4X	blue S4X
3 Cable Length		
1.5 m	0150	
3.0 m	0300	
5.0 m	0500	
7.5 m	0750	
10.0 m	1000	
Technical Data		
Operating voltage	max. 60 V DC	
Protection	IP20 inserted and tightened (EN 60529)	IP67 (M12) - IP20 (RJ45)
Temperature range	-25...+85 °C, depending on cable quality	
Article No.		
The composition of your article number is explained on page 3.1.i	7 7 0 0 - - - - -	- - - - -
	1 Form	2 Cable Type 3 Cable Length
Notes	Other versions on request. Differing cable lengths up to 2 m can be ordered in 0.2 m steps, from 2 m on in 0.5 m steps.	

TPE SERIES - THE NORTH AMERICAN STANDARD

With open ended wires

- 7/8" MINI

- Power

Approvals: 

* only for products with UL/CSA approved cable

Male



straight
TC-ER



Male

straight

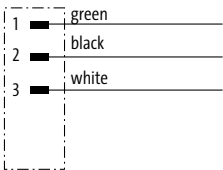

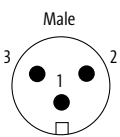
1 Form	A3001	A3001
	Type 3-pole	Type 3-pole
Circuit diagram		
Contact layout		
2 Cable Type	Jacket Color	Jacket Color
	Wire diameter 1.5 mm ² PUR (UL/CSA), C-tracks TPE (UL/CSA), robots	<div style="background-color: yellow; padding: 2px;">yellow</div> <div style="background-color: yellow; padding: 2px;">U1B</div>
3 Cable Length	1.5 m	0150
	3.0 m	0300
	5.0 m	0500
	7.5 m	0750
	10.0 m	1000
Technical Data	Operating voltage	max. 600 V AC/DC
	Protection	IP68 inserted and tightened (EN 60529)
	Temperature range	-25...+80 °C, depending on cable quality
Article No.	The composition of your article number is explained on page 3.1.i	
	<div style="display: flex; justify-content: space-around; align-items: center;"> 7 7 0 0 - - </div>	
	1 Form	2 Cable Type
		3 Cable Length
Notes	Other versions on request. Differing cable lengths up to 2 m can be ordered in 0.2 m steps, from 2 m on in 0.5 m steps.	

TPE Series - The North American standard

TPE SERIES - THE NORTH AMERICAN STANDARD

With open ended wires

- 7/8" MINI

- Power

Male

straight
TC-ER



Male

straight



Approvals:  *

* only for products with UL/CSA approved cable

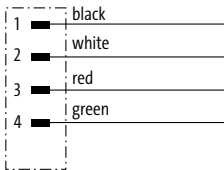
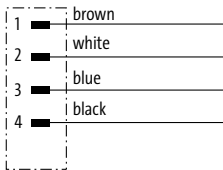
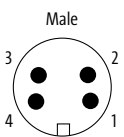
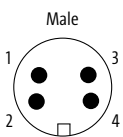
1 Form		A 4 0 0 1	A 4 0 0 1
Type		4-pole	4-pole
Circuit diagram			
Contact layout			
2 Cable Type		Jacket Color	Jacket Color
Wire diameter 1.5 mm ² PUR (UL/CSA), C-tracks TPE (UL/CSA), robots		<div style="background-color: yellow; padding: 2px;">yellow</div> <div style="background-color: yellow; padding: 2px;">U1C</div>	<div style="background-color: black; color: white; padding: 2px;">black</div> <div style="background-color: black; color: white; padding: 2px;">UMC</div>
3 Cable Length			
1.5 m		0150	
3.0 m		0300	
5.0 m		0500	
7.5 m		0750	
10.0 m		1000	
Technical Data			
Operating voltage		max. 600 V AC/DC	
Protection		IP68 inserted and tightened (EN 60529)	
Temperature range		-25...+80 °C, depending on cable quality	
Article No.			
The composition of your article number is explained on page 3.1.i		<div style="border-bottom: 1px solid black; width: 100px; display: inline-block; margin-right: 10px;">7 7 0 0</div> <div style="border-bottom: 1px solid black; width: 100px; display: inline-block; margin-right: 10px;">-</div> <div style="border-bottom: 1px solid black; width: 100px; display: inline-block; margin-right: 10px;">-</div> <div style="border-bottom: 1px solid black; width: 100px; display: inline-block; margin-right: 10px;">-</div> <div style="border-bottom: 1px solid black; width: 100px; display: inline-block; margin-right: 10px;">-</div>	
		1 Form	2 Cable Type
			3 Cable Length
Notes		Other versions on request. Differing cable lengths up to 2 m can be ordered in 0.2 m steps, from 2 m on in 0.5 m steps.	

TPE SERIES - THE NORTH AMERICAN STANDARD

With open ended wires

- 7/8" MINI

- Power

Approvals: 

* only for products with UL/CSA approved cable

Male

straight
TC-ER



Male

straight

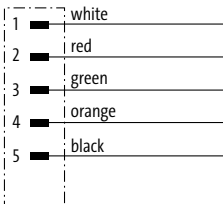
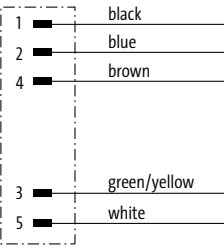
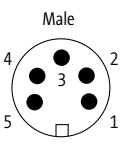

1 Form	A 5001	A 5001
	Type 5-pole	Type 5-pole
Circuit diagram		
Contact layout		
2 Cable Type	Jacket Color	Jacket Color
Wire diameter 1.5 mm ² PUR (UL/CSA), C-tracks TPE (UL/CSA), robots	yellow U1D	black UMD
3 Cable Length		
1.5 m	0150	
3.0 m	0300	
5.0 m	0500	
7.5 m	0750	
10.0 m	1000	
Technical Data		
Operating voltage	max. 600 V AC/DC	
Protection	IP68 inserted and tightened (EN 60529)	
Temperature range	-25...+80 °C, depending on cable quality	
Article No.		
The composition of your article number is explained on page 3.1.i	<div style="display: flex; justify-content: space-around; align-items: center;"> 7 7 0 0 - - </div>	
	1 Form	2 Cable Type
		3 Cable Length
Notes	Other versions on request. Differing cable lengths up to 2 m can be ordered in 0.2 m steps, from 2 m on in 0.5 m steps.	

TPE Series - The North American standard

TPE SERIES - THE NORTH AMERICAN STANDARD

With open ended wires

- 7/8" MINI

- Power

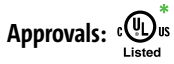

* only for products with UL/CSA approved cable

Male

90°
TC-ER



Male

90°



1 Form		A3011	A3011
Type		3-pole	3-pole
Circuit diagram			
Contact layout			
2 Cable Type		Jacket Color	Jacket Color
Wire diameter 1.5 mm ²		yellow	black
PUR (UL/CSA), C-tracks			UMB
TPE (UL/CSA), robots		U1B	
3 Cable Length			
1.5 m		0150	
3.0 m		0300	
5.0 m		0500	
7.5 m		0750	
10.0 m		1000	
Technical Data			
Operating voltage		max. 600 V AC/DC	
Protection		IP68 inserted and tightened (EN 60529)	
Temperature range		-25...+80 °C, depending on cable quality	
Article No.			
The composition of your article number is explained on page 3.1.i		7 7 0 0 - - - - -	- - - - -
		1 Form	2 Cable Type 3 Cable Length
Notes			
		Other versions on request. Differing cable lengths up to 2 m can be ordered in 0.2 m steps, from 2 m on in 0.5 m steps.	

TPE SERIES - THE NORTH AMERICAN STANDARD

With open ended wires

- 7/8" MINI

- Power

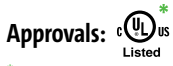

* only for products with UL/CSA approved cable

Male

90°
TC-ER

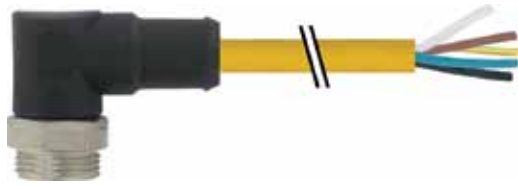

Male

90°



1 Form	Form	A 4 0 1 1		A 4 0 1 1							
	Type	4-pole		4-pole							
	Circuit diagram										
2 Cable Type	Contact layout										
	Jacket Color	<table border="1"> <tr><td>yellow</td></tr> <tr><td>U1C</td></tr> </table>		yellow	U1C	<table border="1"> <tr><td>black</td></tr> <tr><td>UMC</td></tr> </table>		black	UMC		
yellow											
U1C											
black											
UMC											
3 Cable Length	Wire diameter 1.5 mm ²	PUR (UL/CSA), C-tracks		black							
		TPE (UL/CSA), robots		UMC							
	1.5 m	0150									
	3.0 m	0300									
	5.0 m	0500									
Technical Data	7.5 m	0750									
	10.0 m	1000									
	Operating voltage	max. 600 V AC/DC									
	Protection	IP68 inserted and tightened (EN 60529)									
	Temperature range	-25...+80 °C, depending on cable quality									
Article No.	Article No.										
	The composition of your article number is explained on page 3.1.i	<table border="1"> <tr> <td><u>7</u></td> <td><u>7</u></td> <td><u>0</u></td> <td><u>0</u></td> <td>-</td> <td>-</td> <td>-</td> </tr> </table>				<u>7</u>	<u>7</u>	<u>0</u>	<u>0</u>	-	-
<u>7</u>	<u>7</u>	<u>0</u>	<u>0</u>	-	-	-					
Notes		1 Form	2 Cable Type	3 Cable Length							
	Notes	Other versions on request. Differing cable lengths up to 2 m can be ordered in 0.2 m steps, from 2 m on in 0.5 m steps.									

TPE SERIES - THE NORTH AMERICAN STANDARD

With open ended wires

- 7/8" MINI

- Power

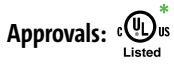

* only for products with UL/CSA approved cable

Male

90°
TC-ER



Male

90°



1 Form	A5011	A5011
	<p>Type 5-pole</p> <p>Circuit diagram</p> <p>Contact layout</p>	<p>Type 5-pole</p> <p>Circuit diagram</p>
2 Cable Type	Jacket Color	Jacket Color
	<p>Wire diameter 1.5 mm² PUR (UL/CSA), C-tracks TPE (UL/CSA), robots</p>	<p>yellow UID</p>
3 Cable Length	1.5 m	0150
	3.0 m	0300
	5.0 m	0500
	7.5 m	0750
	10.0 m	1000
Technical Data	Operating voltage	max. 600 V AC/DC
	Protection	IP68 inserted and tightened (EN 60529)
	Temperature range	-25...+80 °C, depending on cable quality
Article No.	<p>The composition of your article number is explained on page 3.1.i</p> <p>7 7 0 0 - - - - - - - - - -</p>	
Notes	<p>Other versions on request. Differing cable lengths up to 2 m can be ordered in 0.2 m steps, from 2 m on in 0.5 m steps.</p>	

TPE SERIES - THE NORTH AMERICAN STANDARD

With open ended wires

- 7/8" MINI

- Power

Approvals: 

* only for products with UL/CSA approved cable

Female
straight
TC-ER



Female
straight

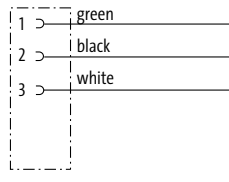
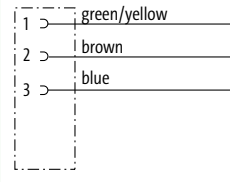
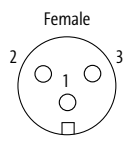

1 Form	A 3 0 2 1	A 3 0 2 1	
	<p>Type 3-pole</p> <p>Circuit diagram</p> 	<p>Type 3-pole</p> <p>Circuit diagram</p> 	
<p>Contact layout</p> 			
2 Cable Type	Jacket Color	Jacket Color	
<p>Wire diameter 1.5 mm² PUR (UL/CSA), C-tracks TPE (UL/CSA), robots</p>	<p>yellow</p> <p>U1B</p>	<p>black</p> <p>UMB</p>	
3 Cable Length			
1.5 m	0150		
3.0 m	0300		
5.0 m	0500		
7.5 m	0750		
10.0 m	1000		
Technical Data			
Operating voltage	max. 600 V AC/DC		
Protection	IP68 inserted and tightened (EN 60529)		
Temperature range	-25...+80 °C, depending on cable quality		
Article No.			
The composition of your article number is explained on page 3.1.i	<u>7</u> <u>7</u> <u>0</u> <u>0</u> - - - - - - - - - -	- - - - - - - - - -	- - - - - - - - - -
	1 Form	2 Cable Type	3 Cable Length
Notes	Other versions on request. Differing cable lengths up to 2 m can be ordered in 0.2 m steps, from 2 m on in 0.5 m steps.		

TPE Series - The North American standard

TPE SERIES - THE NORTH AMERICAN STANDARD

With open ended wires

- 7/8" MINI

- Power

Approvals:  *

* only for products with UL/CSA approved cable

Female
straight
TC-ER



Female
straight

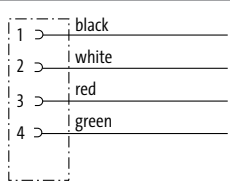
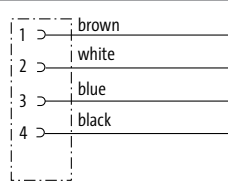
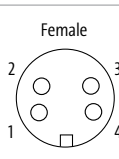
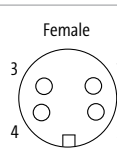

1 Form		A 4 0 2 1	A 4 0 2 1										
Type	4-pole		4-pole										
Circuit diagram													
Contact layout													
2 Cable Type	Jacket Color		Jacket Color										
Wire diameter 1.5 mm ² PUR (UL/CSA), C-tracks TPE (UL/CSA), robots	<table border="1"> <tr><td>yellow</td></tr> <tr><td>U1C</td></tr> </table>		yellow	U1C	<table border="1"> <tr><td>black</td></tr> <tr><td>UMC</td></tr> </table>	black	UMC						
yellow													
U1C													
black													
UMC													
3 Cable Length	<table border="1"> <tr><td>1.5 m</td><td>0150</td></tr> <tr><td>3.0 m</td><td>0300</td></tr> <tr><td>5.0 m</td><td>0500</td></tr> <tr><td>7.5 m</td><td>0750</td></tr> <tr><td>10.0 m</td><td>1000</td></tr> </table>			1.5 m	0150	3.0 m	0300	5.0 m	0500	7.5 m	0750	10.0 m	1000
1.5 m	0150												
3.0 m	0300												
5.0 m	0500												
7.5 m	0750												
10.0 m	1000												
Technical Data	<table border="1"> <tr><td>Operating voltage</td><td>max. 600 V AC/DC</td></tr> <tr><td>Protection</td><td>IP68 inserted and tightened (EN 60529)</td></tr> <tr><td>Temperature range</td><td>-25...+80 °C, depending on cable quality</td></tr> </table>			Operating voltage	max. 600 V AC/DC	Protection	IP68 inserted and tightened (EN 60529)	Temperature range	-25...+80 °C, depending on cable quality				
Operating voltage	max. 600 V AC/DC												
Protection	IP68 inserted and tightened (EN 60529)												
Temperature range	-25...+80 °C, depending on cable quality												
Article No.	<p>The composition of your article number is explained on page 3.1.i</p> <p><u>7 7 0 0</u> -</p>												
	1 Form	2 Cable Type	3 Cable Length										
Notes	Other versions on request. Differing cable lengths up to 2 m can be ordered in 0.2 m steps, from 2 m on in 0.5 m steps.												

TPE SERIES - THE NORTH AMERICAN STANDARD

With open ended wires

- 7/8" MINI

- Power

Approvals: 

* only for products with UL/CSA approved cable

Female
straight
TC-ER



Female
straight

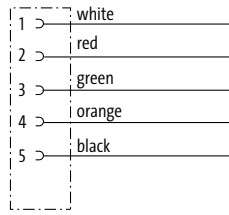
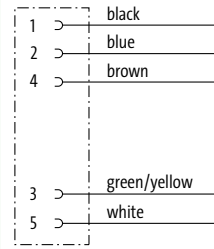
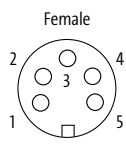

1 Form	A 5021	A 5021
	5-pole	5-pole
Circuit diagram		
Contact layout		
2 Cable Type	Jacket Color	Jacket Color
Wire diameter 1.5 mm ² PUR (UL/CSA), C-tracks TPE (UL/CSA), robots	yellow U1D	black UMD
3 Cable Length		
1.5 m	0150	
3.0 m	0300	
5.0 m	0500	
7.5 m	0750	
10.0 m	1000	
Technical Data		
Operating voltage	max. 600 V AC/DC	
Protection	IP68 inserted and tightened (EN 60529)	
Temperature range	-25...+80 °C, depending on cable quality	
Article No.		
The composition of your article number is explained on page 3.1.i	<div style="display: flex; justify-content: space-around; align-items: center;"> 7 7 0 0 - - </div>	
	1 Form	2 Cable Type
		3 Cable Length
Notes	Other versions on request. Differing cable lengths up to 2 m can be ordered in 0.2 m steps, from 2 m on in 0.5 m steps.	

TPE Series - The North American standard

TPE SERIES - THE NORTH AMERICAN STANDARD

With open ended wires

- 7/8" MINI

- Power



* only for products with UL/CSA approved cable

Female

90°
TC-ER



Female

90°



1 Form	A3031	A3031				
	Type 3-pole	Type 3-pole				
Circuit diagram						
	Contact layout					
2 Cable Type	Jacket Color	Jacket Color				
	Wire diameter 1.5 mm ² PUR (UL/CSA), C-tracks TPE (UL/CSA), robots	<table border="1"> <tr><td>yellow</td></tr> <tr><td>U1B</td></tr> </table>	yellow	U1B	<table border="1"> <tr><td>black</td></tr> <tr><td>UMB</td></tr> </table>	black
yellow						
U1B						
black						
UMB						
3 Cable Length	1.5 m	0150				
	3.0 m	0300				
	5.0 m	0500				
	7.5 m	0750				
	10.0 m	1000				
Technical Data	Operating voltage	max. 600 V AC/DC				
	Protection	IP68 inserted and tightened (EN 60529)				
	Temperature range	-25...+80 °C, depending on cable quality				
Article No.	<div style="display: flex; justify-content: space-between; align-items: center;"> <div style="border: 1px solid black; padding: 5px;">7 7 0 0</div> <div style="font-size: 2em;">-</div> <div style="border: 1px solid black; width: 100px; height: 20px;"></div> <div style="font-size: 2em;">-</div> <div style="border: 1px solid black; width: 100px; height: 20px;"></div> </div>					
The composition of your article number is explained on page 3.1.i	1 Form	2 Cable Type	3 Cable Length			
Notes	Other versions on request. Differing cable lengths up to 2 m can be ordered in 0.2 m steps, from 2 m on in 0.5 m steps.					

TPE SERIES - THE NORTH AMERICAN STANDARD

With open ended wires

- 7/8" MINI

- Power

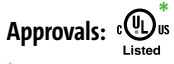

* only for products with UL/CSA approved cable

Female

90°
TC-ER



Female

90°



1 Form		A 4 0 3 1	A 4 0 3 1
Type	4-pole	4-pole	4-pole
Circuit diagram			
Contact layout			
2 Cable Type		Jacket Color	Jacket Color
Wire diameter 1.5 mm ²		yellow	black
PUR (UL/CSA), C-tracks			UMC
TPE (UL/CSA), robots		U1C	
3 Cable Length			
1.5 m		0150	
3.0 m		0300	
5.0 m		0500	
7.5 m		0750	
10.0 m		1000	
Technical Data			
Operating voltage		max. 600 V AC/DC	
Protection		IP68 inserted and tightened (EN 60529)	
Temperature range		-25...+80 °C, depending on cable quality	
Article No.			
The composition of your article number is explained on page 3.1.i		7 7 0 0 - - - - -	- - - - -
		1 Form	2 Cable Type
			3 Cable Length
Notes			
		Other versions on request. Differing cable lengths up to 2 m can be ordered in 0.2 m steps, from 2 m on in 0.5 m steps.	

TPE SERIES - THE NORTH AMERICAN STANDARD

With open ended wires

- 7/8" MINI

- Power



* only for products with UL/CSA approved cable

Female

90°
TC-ER



Female

90°



1 Form	A5031	A5031
	<p>Type 5-pole</p> <p>Circuit diagram</p> <p>Contact layout</p>	<p>Type 5-pole</p> <p>Circuit diagram</p>
2 Cable Type	Jacket Color	Jacket Color
<p>Wire diameter 1.5 mm² PUR (UL/CSA), C-tracks TPE (UL/CSA), robots</p>	<p>yellow</p> <p>U1D</p>	<p>black</p> <p>UMD</p>
3 Cable Length		
1.5 m	0150	
3.0 m	0300	
5.0 m	0500	
7.5 m	0750	
10.0 m	1000	
Technical Data		
Operating voltage	max. 600 V AC/DC	
Protection	IP68 inserted and tightened (EN 60529)	
Temperature range	-25...+80 °C, depending on cable quality	
Article No.		
The composition of your article number is explained on page 3.1.i	7 7 0 0 - - - - -	- - - - -
	1 Form	2 Cable Type
		3 Cable Length
Notes	Other versions on request. Differing cable lengths up to 2 m can be ordered in 0.2 m steps, from 2 m on in 0.5 m steps.	

TPE SERIES - THE NORTH AMERICAN STANDARD

Connection cables

- 7/8" MINI - 7/8" MINI

- Power

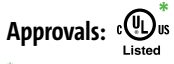

* only for products with UL/CSA approved cable

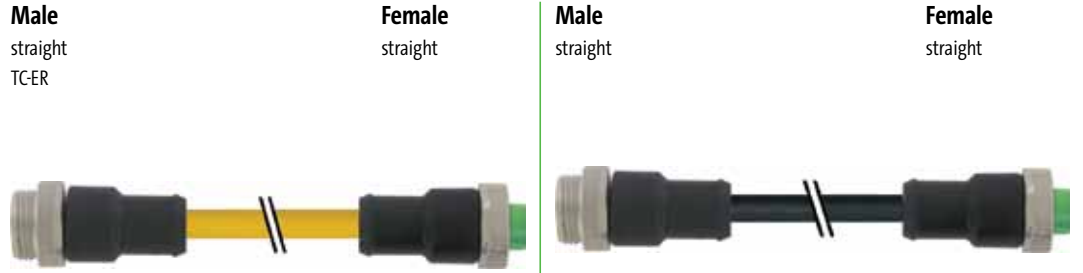

1 Form		A3A01	A3A01
Type	3-pole	3-pole	3-pole
Circuit diagram			
Contact layout			
2 Cable Type	Jacket Color	Jacket Color	Jacket Color
Wire diameter 1.5 mm ² PUR (UL/CSA), C-tracks TPE (UL/CSA), robots	yellow U1B	black UMB	
3 Cable Length			
1.5 m	0150		
3.0 m	0300		
5.0 m	0500		
7.5 m	0750		
10.0 m	1000		
Technical Data			
Operating voltage	max. 600 V AC/DC		
Protection	IP68 inserted and tightened (EN 60529)		
Temperature range	-25...+80 °C, depending on cable quality		
Article No.			
The composition of your article number is explained on page 3.1.i	7 7 0 0	-	-
	1 Form	2 Cable Type	3 Cable Length
Notes	Other versions on request. Differing cable lengths up to 2 m can be ordered in 0.2 m steps, from 2 m on in 0.5 m steps.		

TPE SERIES - THE NORTH AMERICAN STANDARD

Connection cables

– 7/8" MINI - 7/8" MINI

– Power

Male

90°
TC-ER

Female

90°

Male

90°

Female

90°

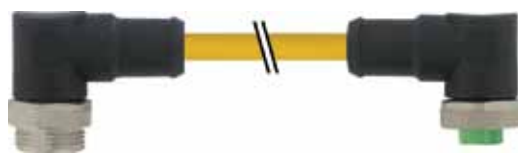

Approvals: *

* only for products with UL/CSA approved cable

1 Form		A3A31	A3A31
Type		3-pole	3-pole
Circuit diagram			
Contact layout			
2 Cable Type		Jacket Color	Jacket Color
Wire diameter 1.5 mm ²		yellow	black
PUR (UL/CSA), C-tracks			UMB
TPE (UL/CSA), robots		U1B	
3 Cable Length			
1.5 m		0150	
3.0 m		0300	
5.0 m		0500	
7.5 m		0750	
10.0 m		1000	
Technical Data			
Operating voltage		max. 600 V AC/DC	
Protection		IP68 inserted and tightened (EN 60529)	
Temperature range		-25...+80 °C, depending on cable quality	
Article No.			
The composition of your article number is explained on page 3.1.i		7 7 0 0 - - - - - - - - - -	- - - - -
		1 Form	2 Cable Type
			3 Cable Length
Notes		Other versions on request. Differing cable lengths up to 2 m can be ordered in 0.2 m steps, from 2 m on in 0.5 m steps.	

TPE SERIES - THE NORTH AMERICAN STANDARD

Connection cables

– 7/8" MINI - 7/8" MINI

– Power

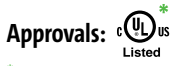

* only for products with UL/CSA approved cable

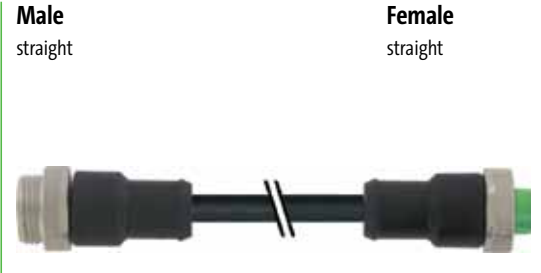
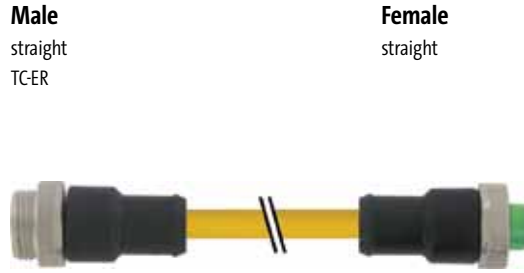

1 Form		A4A01		A4A01	
Type	4-pole			4-pole	
Circuit diagram					
Contact layout					
2 Cable Type	Jacket Color	yellow		black	
Wire diameter 1.5 mm ²		U1C		UMC	
PUR (UL/CSA), C-tracks					
TPE (UL/CSA), robots					
3 Cable Length					
1.5 m	0150				
3.0 m	0300				
5.0 m	0500				
7.5 m	0750				
10.0 m	1000				
Technical Data					
Operating voltage	max. 600 V AC/DC				
Protection	IP68 inserted and tightened (EN 60529)				
Temperature range	-25...+80 °C, depending on cable quality				
Article No.					
The composition of your article number is explained on page 3.1.i		7 7 0 0 - - - - -		- - - - -	
		1 Form		2 Cable Type	
				3 Cable Length	
Notes	Other versions on request. Differing cable lengths up to 2 m can be ordered in 0.2 m steps, from 2 m on in 0.5 m steps.				

TPE Series - The North American standard

TPE SERIES - THE NORTH AMERICAN STANDARD

Connection cables

– 7/8" MINI - 7/8" MINI

– Power

Male

90°
TC-ER

Female

90°

Male

90°

Female

90°

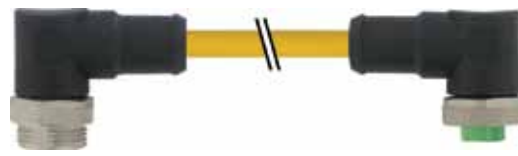

Approvals: *

* only for products with UL/CSA approved cable

1 Form		A 4 A 31	A 4 A 31
Type		4-pole	4-pole
Circuit diagram			
Contact layout			
2 Cable Type		Jacket Color	Jacket Color
Wire diameter 1.5 mm ²		yellow	black
PUR (UL/CSA), C-tracks			UMC
TPE (UL/CSA), robots		U1C	
3 Cable Length			
1.5 m		0150	
3.0 m		0300	
5.0 m		0500	
7.5 m		0750	
10.0 m		1000	
Technical Data			
Operating voltage		max. 600 V AC/DC	
Protection		IP68 inserted and tightened (EN 60529)	
Temperature range		-25...+80 °C, depending on cable quality	
Article No.			
The composition of your article number is explained on page 3.1.i		7 7 0 0	- - - - -
		1 Form	2 Cable Type
			3 Cable Length
Notes		Other versions on request. Differing cable lengths up to 2 m can be ordered in 0.2 m steps, from 2 m on in 0.5 m steps.	

TPE SERIES - THE NORTH AMERICAN STANDARD

Connection cables

– 7/8" MINI - 7/8" MINI

– Power

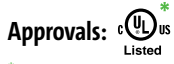

* only for products with UL/CSA approved cable

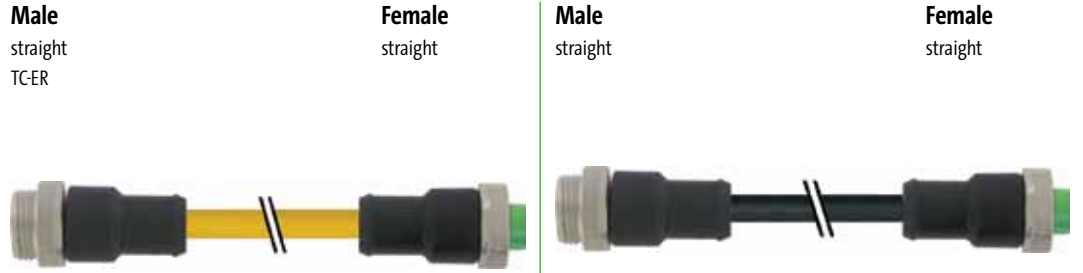

1 Form		A5A01	A5A01
Type	5-pole	5-pole	5-pole
Circuit diagram			
Contact layout			
2 Cable Type	Jacket Color	Jacket Color	Jacket Color
Wire diameter 1.5 mm ² PUR (UL/CSA), C-tracks TPE (UL/CSA), robots	yellow U1D		black UMD
3 Cable Length			
1.5 m	0150		
3.0 m	0300		
5.0 m	0500		
7.5 m	0750		
10.0 m	1000		
Technical Data			
Operating voltage	max. 600 V AC/DC		
Protection	IP68 inserted and tightened (EN 60529)		
Temperature range	-25...+80 °C, depending on cable quality		
Article No.			
The composition of your article number is explained on page 3.1.i	7 7 0 0	-	-
	1 Form	2 Cable Type	3 Cable Length
Notes	Other versions on request. Differing cable lengths up to 2 m can be ordered in 0.2 m steps, from 2 m on in 0.5 m steps.		

TPE SERIES - THE NORTH AMERICAN STANDARD

Connection cables

– 7/8" MINI - 7/8" MINI

– Power

Male

90°
TC-ER

Female

90°

Male

90°

Female

90°



Approvals: 

* only for products with UL/CSA approved cable

1 Form		A5A31	A5A31
Type		5-pole	5-pole
Circuit diagram			
Contact layout			
2 Cable Type		Jacket Color	Jacket Color
Wire diameter 1.5 mm ²		yellow	black
PUR (UL/CSA), Ctracks			UMD
TPE (UL/CSA), robots		U1D	
3 Cable Length			
1.5 m		0150	
3.0 m		0300	
5.0 m		0500	
7.5 m		0750	
10.0 m		1000	
Technical Data			
Operating voltage		max. 600 V AC/DC	
Protection		IP68 inserted and tightened (EN 60529)	
Temperature range		-25...+80 °C, depending on cable quality	
Article No.			
The composition of your article number is explained on page 3.1.i		7 7 0 0	- - - - -
		1 Form	2 Cable Type
			3 Cable Length
Notes		Other versions on request. Differing cable lengths up to 2 m can be ordered in 0.2 m steps, from 2 m on in 0.5 m steps.	









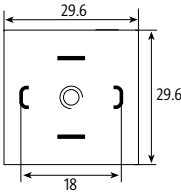

VALVE CONNECTORS MORE MODELS THAN EVER

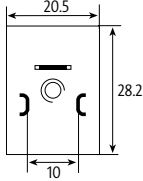
- Molded construction – resistant to shock and vibration
- Tested to ensure reliability
- IP65 to IP67 Rated

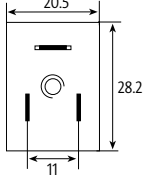
THE CONNECTOR FOR VALVES AND PRESSURE SWITCHES

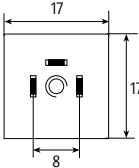
25 years ago, Murrelektronik developed and produced the first pre-wired and molded valve connector. It was a revolution! Now, more than ever, Murrelektronik's valve plugs enjoy long-running success as a result of continuous improvement. A captive gasket, integrated LED status indicator and suppression are the top features of Murrelektronik's MSUD valve plug.

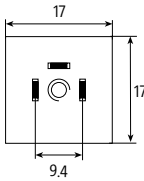
With Open Ended Wires		Valve Diagram		
		MSUD Valve Connector • Form A acc. to EN 175301-803 (ISO 4400) Pin spacing 18 mm		<i>Page 3.12.1</i>
		MSUD Valve Connector • Form B acc. to EN 175301-803 (ISO 6952) Pin spacing 10 mm		<i>Page 3.12.4</i>
		MSUD Valve Connector • Form BI Industrial standard Pin spacing 11 mm		<i>Page 3.12.6</i>
		MSUD Valve Connector • Form C acc. to EN 175301-803 (ISO 6952) Pin spacing 8 mm		<i>Page 3.12.8</i>
		MSUD Valve Connector • Form CI Industrial standard Pin spacing 9.4 mm		<i>Page 3.12.10</i>

Connection Cables

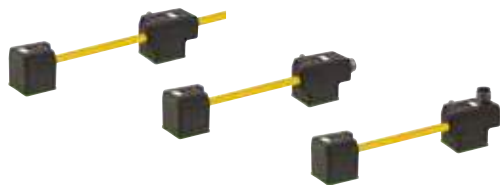

MSUD Double Valve Connector

- Form A
- Form B
- Form BI
- Form C
- Form CI

M12 male

- Top connection
- Rear connection
- With connection cable

Page 3.12.12

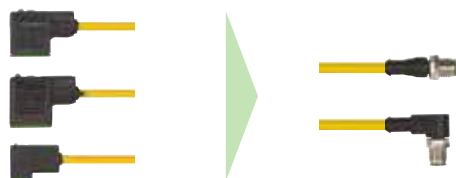

MSUD Valve Connector

- Form A
- Form B
- Form BI
- Form C
- Form CI

M12 male

- Straight
- 90°

Page 3.12.19



MSUD Valve Connector Adapter

- Form A
- Form B
- Form BI
- Form C
- Form CI

M12 male

- Top connection
- Rear connection

Page 3.12.23

Field-Wireable



Screw Terminals

SVS Valve Connector

- Form A
- Form B
- Form BI

Page 3.12.27



Insulation Displacement Technology (IDC)

MOSA Valve Connector

- Form C
- Form CI

Page 3.12.35



Screw Terminals

SVS Eco Valve Connector

- Form A
- Form B
- Form BI
- Form C
- Form CI

Page 3.12.36

VALVE CONNECTORS

MSUD

– with open ended wires

Form A (18 mm)

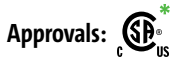

* only for products with UL/CSA approved cable

1 Form	18001	18021	18041						
Type	24 V AC/DC ±25%	24 V AC ±20% / DC ±25%	110 V AC/DC ±10%						
Circuit diagram	<p>LED</p>	<p>LED and suppression</p>	<p>LED and suppression</p>						
Contact layout									
2 Cable Type	Jacket Color								
Wire diameter 0.75 mm ²	yellow	gray	black	yellow	gray	black	yellow	gray	black
PVC	016	216	616	016	216	616	016	216	616
PUR/PVC (UL/CSA)	026	226	626	026	226	626	026	226	626
PUR (UL/CSA), robots/C-tracks	036	236	636	036	236	636	036	236	636
PUR (UL/CSA), welding spark	056	256	656	056	256	656	056	256	656
3 Cable Length									
1.5 m	0150								
3.0 m	0300								
5.0 m	0500								
7.5 m	0750								
10.0 m	1000								
Technical Data									
Operating voltage	24 V AC/DC ±25%		24 V AC ±20% / DC ±25%			110 V AC/DC ±10%			
Protection	IP67 inserted and tightened (EN 60529)								
Temperature range	-25...+85 °C, depending on cable quality								
Article No.									
The composition of your article number is explained on page 3.1.i	<div style="display: flex; justify-content: space-around; align-items: center;"> 7 0 0 0 - _ - _ _ _ </div>								
	1 Form			2 Cable Type			3 Cable Length		
Notes	Other versions on request. Differing cable lengths up to 2 m can be ordered in 0.2 m steps, from 2 m on in 0.5 m steps.								

VALVE CONNECTORS

MSUD

– with open ended wires

Form A (18 mm)

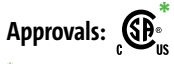

* only for products with UL/CSA approved cable

1 Form		18061	18081				
Type		230 V AC/DC ±10%	max. 230 V AC/DC				
		LED and suppression	without components				
Circuit diagram							
Contact layout							
2 Cable Type		Jacket Color			Jacket Color		
Wire diameter 0.75 mm ²		yellow	gray	black	yellow	gray	black
PVC		016	216	616	016	216	616
PUR/PVC (UL/CSA)		026	226	626	026	226	626
PUR (UL/CSA), robots/C-tracks		036	236	636	036	236	636
PUR (UL/CSA), welding spark		056	256	656	056	256	656
3 Cable Length							
1.5 m		0150					
3.0 m		0300					
5.0 m		0500					
7.5 m		0750					
10.0 m		1000					
Technical Data							
Operating voltage		230 V AC/DC ±10%			max. 230 V AC/DC		
Protection		IP67 inserted and tightened (EN 60529)					
Temperature range		-25...+85 °C, depending on cable quality					
Article No.							
The composition of your article number is explained on page 3.1.i		7 0 0 0		-	-		-
		1 Form		2 Cable Type		3 Cable Length	
Notes		Other versions on request. Differing cable lengths up to 2 m can be ordered in 0.2 m steps, from 2 m on in 0.5 m steps.					

Valve Connectors

VALVE CONNECTORS

MSUD

- with open ended wires
- for pressure switches

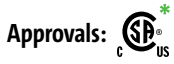

* only for products with UL/CSA approved cable

Form A (18 mm)



1 Form		18121	18141				
Type	24 V DC ±25%	LED (red/green)	24 V DC ±25%				
Circuit diagram							
Contact layout							
2 Cable Type		Jacket Color			Jacket Color		
Wire diameter 0.75 mm ²	yellow	gray	black	yellow	gray	black	
PVC	018	218	618	018	218	618	
PUR/PVC (UL/CSA)	028	228	628	028	228	628	
PUR (UL/CSA), robots/Ctracks	038	238	638	038	238	638	
3 Cable Length							
1.5 m	0150						
3.0 m	0300						
5.0 m	0500						
7.5 m	0750						
10.0 m	1000						
Technical Data							
Operating voltage	24 V DC ±25%						
Protection	IP67 inserted and tightened (EN 60529)						
Temperature range	-25...+85 °C, depending on cable quality						
Article No.							
The composition of your article number is explained on page 3.1.i	<div style="display: flex; justify-content: space-around; align-items: center;"> 7 0 0 0 - - - - - </div>						
	1	Form	2	Cable Type	3	Cable Length	
Notes	Other versions on request. Differing cable lengths up to 2 m can be ordered in 0.2 m steps, from 2 m on in 0.5 m steps.						

VALVE CONNECTORS

MSUD

– with open ended wires

Form B (10 mm)



Approvals:

* only for products with UL/CSA approved cable

1 Form	10001	10021	10041						
Type	24 V AC/DC ±25%	24 V AC ±20% / DC ±25%	110 V AC/DC ±10%						
	LED	LED and suppression	LED and suppression						
Circuit diagram									
Contact layout									
2 Cable Type	Jacket Color								
Wire diameter 0.75 mm ²	yellow	gray	black	yellow	gray	black	yellow	gray	black
PVC	016	216	616	016	216	616	016	216	616
PUR/PVC (UL/CSA)	026	226	626	026	226	626	026	226	626
PUR (UL/CSA), robots/C-tracks	036	236	636	036	236	636	036	236	636
PUR (UL/CSA), welding spark	056	256	656	056	256	656	056	256	656
3 Cable Length									
1.5 m	0150								
3.0 m	0300								
5.0 m	0500								
7.5 m	0750								
10.0 m	1000								
Technical Data									
Operating voltage	24 V AC/DC ±25%			24 V AC ±20% / DC ±25%			110 V AC/DC ±10%		
Protection	IP67 inserted and tightened (EN 60529)								
Temperature range	-25...+85 °C, depending on cable quality								
Article No.									
The composition of your article number is explained on page 3.1.i	<div style="display: flex; justify-content: space-around; align-items: center;"> 7 0 0 0 - _ - _ _ _ </div>								
	1 Form			2 Cable Type			3 Cable Length		
Notes	Other versions on request. Differing cable lengths up to 2 m can be ordered in 0.2 m steps, from 2 m on in 0.5 m steps.								

VALVE CONNECTORS

MSUD

– with open ended wires

Form B (10 mm)



Approvals: 

* only for products with UL/CSA approved cable

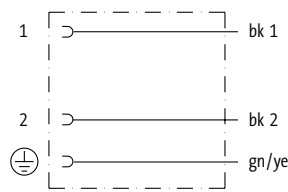
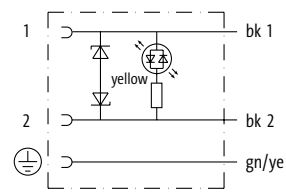
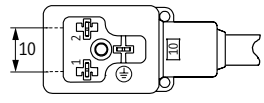
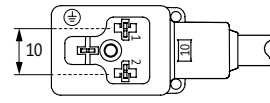
1 Form	10061	10081
Type	max. 230 V AC/DC without components	24 V AC ±20% / DC ±25% LED and suppression
Circuit diagram		
Contact figure	PE at cable entry (0°)	PE opposite cable entry (180°)
Contact layout		
2 Cable Type	Jacket Color	Jacket Color
Wire diameter 0.75 mm ²	yellow gray black	yellow gray black
PVC	016 216 616	016 216 616
PUR/PVC (UL/CSA)	026 226 626	026 226 626
PUR (UL/CSA), robots/C-tracks	036 236 636	036 236 636
PUR (UL/CSA), welding spark	056 256 656	056 256 656
3 Cable Length		
1.5 m	0150	
3.0 m	0300	
5.0 m	0500	
7.5 m	0750	
10.0 m	1000	
Technical Data		
Operating voltage	max. 230 V AC/DC	24 V AC ±20% / DC ±25%
Protection	IP67 inserted and tightened (EN 60529)	
Temperature range	-25...+85 °C, depending on cable quality	
Article No.		
The composition of your article number is explained on page 3.1.i	<div style="display: flex; justify-content: space-around; align-items: center;"> 7 0 0 0 - - </div>	
	1 Form	2 Cable Type
		3 Cable Length
Notes	Other versions on request. Differing cable lengths up to 2 m can be ordered in 0.2 m steps, from 2 m on in 0.5 m steps.	

VALVE CONNECTORS

MSUD

– with open ended wires

Form BI (11 mm)

Industrial standard

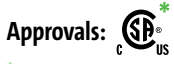

* only for products with UL/CSA approved cable

1 Form	11001	11021	11041
Type	24 V AC/DC ±25%	24 V AC ±20% / DC ±25%	110 V AC/DC ±10%
Circuit diagram			
Contact layout			
2 Cable Type	Jacket Color		
Wire diameter 0.75 mm ²	yellow	gray	black
PVC	016	216	616
PUR/PVC (UL/CSA)	026	226	626
PUR (UL/CSA), robots/C-tracks	036	236	636
PUR (UL/CSA), welding spark	056	256	656
3 Cable Length			
1.5 m	0150		
3.0 m	0300		
5.0 m	0500		
7.5 m	0750		
10.0 m	1000		
Technical Data			
Operating voltage	24 V AC/DC ±25%	24 V AC ±20% / DC ±25%	110 V AC/DC ±10%
Protection	IP67 inserted and tightened (EN 60529)		
Temperature range	-25...+85 °C, depending on cable quality		
Article No.			
The composition of your article number is explained on page 3.1.i	7 0 0 0	-	-
	1 Form	2 Cable Type	3 Cable Length
Notes	Other versions on request. Differing cable lengths up to 2 m can be ordered in 0.2 m steps, from 2 m on in 0.5 m steps.		

Valve Connectors

VALVE CONNECTORS

MSUD

– with open ended wires

Form BI (11 mm)

Industrial standard



Approvals: 

* only for products with UL/CSA approved cable

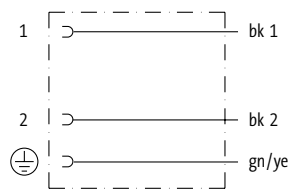
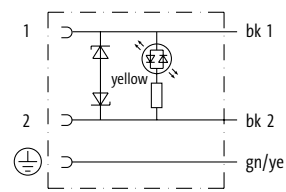
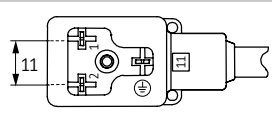
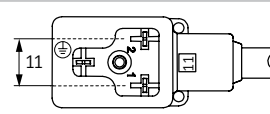
1 Form	11061	11081
Type	max. 250 V AC/DC without components	24 V AC ±20% / DC ±25% LED and suppression
Circuit diagram		
Contact figure	PE at cable entry (0°)	PE opposite cable entry (180°)
Contact layout		
2 Cable Type	Jacket Color	Jacket Color
Wire diameter 0.75 mm ²	yellow gray black	yellow gray black
PVC	016 216 616	016 216 616
PUR/PVC (UL/CSA)	026 226 626	026 226 626
PUR (UL/CSA), robots/C-tracks	036 236 636	036 236 636
PUR (UL/CSA), welding spark	056 256 656	056 256 656
3 Cable Length		
1.5 m	0150	
3.0 m	0300	
5.0 m	0500	
7.5 m	0750	
10.0 m	1000	
Technical Data		
Operating voltage	max. 250 V AC/DC	24 V AC ±20% / DC ±25%
Protection	IP67 inserted and tightened (EN 60529)	
Temperature range	-25...+85 °C, depending on cable quality	
Article No.		
The composition of your article number is explained on page 3.1.i	7 0 0 0 - - - - -	- - - - -
	1 Form	2 Cable Type 3 Cable Length
Notes	Other versions on request. Differing cable lengths up to 2 m can be ordered in 0.2 m steps, from 2 m on in 0.5 m steps.	

VALVE CONNECTORS

MSUD

– with open ended wires

Form C (8 mm)

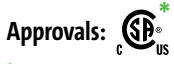

* only for products with UL/CSA approved cable

1 Form		80001			80021		
Type	24 V AC/DC ±25%	LED			24 V AC ±20% / DC ±25%		
Circuit diagram							
Contact layout							
2 Cable Type		Jacket Color			Jacket Color		
Wire diameter 0.75 mm ²	yellow	gray	black	yellow	gray	black	
PVC	016	216	616	016	216	616	
PUR/PVC (UL/CSA)	026	226	626	026	226	626	
PUR (UL/CSA), robots/C-tracks	036	236	636	036	236	636	
PUR (UL/CSA), welding spark	056	256	656	056	256	656	
3 Cable Length							
1.5 m	0150						
3.0 m	0300						
5.0 m	0500						
7.5 m	0750						
10.0 m	1000						
Technical Data							
Operating voltage	24 V AC/DC ±25%				24 V AC ±20% / DC ±25%		
Protection	IP67 inserted and tightened (EN 60529)						
Temperature range	-25...+85 °C, depending on cable quality						
Article No.							
The composition of your article number is explained on page 3.1.i	7 0 0 0			-		-	
	1 Form		2 Cable Type		3 Cable Length		
Notes		Other versions on request. Differing cable lengths up to 2 m can be ordered in 0.2 m steps, from 2 m on in 0.5 m steps.					

Valve Connectors

VALVE CONNECTORS

MSUD

– with open ended wires

Form C (8 mm)



Approvals: 

* only for products with UL/CSA approved cable

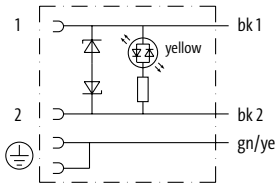
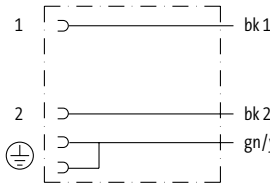
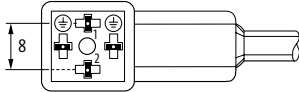
1 Form		80041			80061		
Type	110 V AC/DC ±10%	LED and suppression			max. 230 V AC/DC		
Circuit diagram							
Contact layout							
2 Cable Type		Jacket Color			Jacket Color		
Wire diameter 0.75 mm ²	yellow	gray	black	yellow	gray	black	
PVC	016	216	616	016	216	616	
PUR/PVC (UL/CSA)	026	226	626	026	226	626	
PUR (UL/CSA), robots/C-tracks	036	236	636	036	236	636	
PUR (UL/CSA), welding spark	056	256	656	056	256	656	
3 Cable Length							
1.5 m	0150						
3.0 m	0300						
5.0 m	0500						
7.5 m	0750						
10.0 m	1000						
Technical Data							
Operating voltage	110 V AC/DC ±10%	max. 230 V AC/DC					
Protection	IP67 inserted and tightened (EN 60529)						
Temperature range	-25...+85 °C, depending on cable quality						
Article No.							
The composition of your article number is explained on page 3.1.i	<div style="text-align: center; font-family: monospace; font-size: 1.2em;"> 7 0 0 0 - - - </div>						
	1	Form			2	Cable Type	
					3	Cable Length	
Notes	Other versions on request. Differing cable lengths up to 2 m can be ordered in 0.2 m steps, from 2 m on in 0.5 m steps.						

VALVE CONNECTORS

MSUD

– with open ended wires

Form CI (9.4 mm)

Industrial standard



* only for products with UL/CSA approved cable

1 Form		94001	94021				
Type		24 V AC/DC ±25%	24 V AC ±20% / DC ±25%				
Circuit diagram		<p>LED</p>	<p>LED and suppression</p>				
Contact layout							
2 Cable Type		Jacket Color			Jacket Color		
Wire diameter 0.75 mm ²		yellow	gray	black	yellow	gray	black
PVC		016	216	616	016	216	616
PUR/PVC (UL/CSA)		026	226	626	026	226	626
PUR (UL/CSA), robots/C-tracks		036	236	636	036	236	636
PUR (UL/CSA), welding spark		056	256	656	056	256	656
3 Cable Length							
1.5 m		0150					
3.0 m		0300					
5.0 m		0500					
7.5 m		0750					
10.0 m		1000					
Technical Data							
Operating voltage		24 V AC/DC ±25%			24 V AC ±20% / DC ±25%		
Protection		IP67 inserted and tightened (EN 60529)					
Temperature range		-25...+85 °C, depending on cable quality					
Article No.							
The composition of your article number is explained on page 3.1.i		7 0 0 0		-	-		-
		1 Form		2 Cable Type		3 Cable Length	
Notes		Other versions on request. Differing cable lengths up to 2 m can be ordered in 0.2 m steps, from 2 m on in 0.5 m steps.					

VALVE CONNECTORS

MSUD

– with open ended wires

Form CI (9.4 mm)

Industrial standard



Approvals:

* only for products with UL/CSA approved cable

1 Form		94041			94061		
Type	110 V AC/DC ±10%	LED and suppression			max. 230 V AC/DC		
Circuit diagram							
Contact layout							
2 Cable Type		Jacket Color			Jacket Color		
Wire diameter 0.75 mm ²	yellow	gray	black	yellow	gray	black	
PVC	016	216	616	016	216	616	
PUR/PVC (UL/CSA)	026	226	626	026	226	626	
PUR (UL/CSA), robots/C-tracks	036	236	636	036	236	636	
PUR (UL/CSA), welding spark	056	256	656	056	256	656	
3 Cable Length							
1.5 m	0150						
3.0 m	0300						
5.0 m	0500						
7.5 m	0750						
10.0 m	1000						
Technical Data							
Operating voltage	110 V AC/DC ±10%			max. 230 V AC/DC			
Protection	IP67 inserted and tightened (EN 60529)						
Temperature range	-25...+85 °C, depending on cable quality						
Article No.							
The composition of your article number is explained on page 3.1.i	<div style="display: flex; justify-content: space-around; align-items: center;"> 7 0 0 0 - - </div>						
	1	2	3				
	Form	Cable Type	Cable Length				
Notes		Other versions on request. Differing cable lengths up to 2 m can be ordered in 0.2 m steps, from 2 m on in 0.5 m steps.					

VALVE CONNECTORS

MSUD - MSUD

– Double valve plugs with connection cable

Form A (18 mm)



Approvals: 

* only for products with UL/CSA approved cable

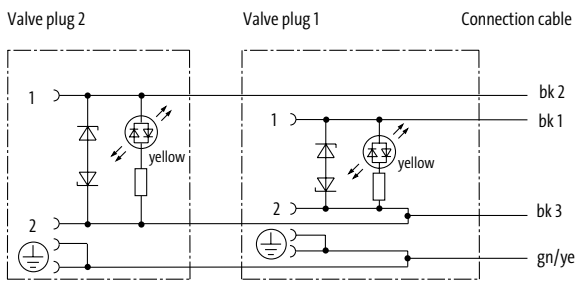
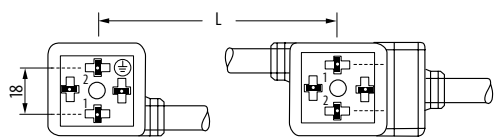
1 Form	58001	58021	58041																																																	
	24 V AC ±20% / DC ±25%		24 V AC ±20% / DC ±25%																																																	
	LED and suppression L = 110 mm		LED and suppression L = 150 mm																																																	
Circuit diagram																																																				
Contact layout																																																				
2 Cable Type	<table border="1"> <thead> <tr> <th rowspan="2">Wire diameter 0.75 mm²</th> <th colspan="3">Jacket Color</th> <th colspan="3">Jacket Color</th> <th colspan="3">Jacket Color</th> </tr> <tr> <th>yellow</th> <th>gray</th> <th>black</th> <th>yellow</th> <th>gray</th> <th>black</th> <th>yellow</th> <th>gray</th> <th>black</th> </tr> </thead> <tbody> <tr> <td>PVC</td> <td>017</td> <td>217</td> <td>617</td> <td>017</td> <td>217</td> <td>617</td> <td>017</td> <td>217</td> <td>617</td> </tr> <tr> <td>PUR/PVC (UL/CSA)</td> <td>027</td> <td>227</td> <td>627</td> <td>027</td> <td>227</td> <td>627</td> <td>027</td> <td>227</td> <td>627</td> </tr> <tr> <td>PUR (UL/CSA), robots/Ctracks</td> <td>037</td> <td>237</td> <td>637</td> <td>037</td> <td>237</td> <td>637</td> <td>037</td> <td>237</td> <td>637</td> </tr> </tbody> </table>			Wire diameter 0.75 mm ²	Jacket Color			Jacket Color			Jacket Color			yellow	gray	black	yellow	gray	black	yellow	gray	black	PVC	017	217	617	017	217	617	017	217	617	PUR/PVC (UL/CSA)	027	227	627	027	227	627	027	227	627	PUR (UL/CSA), robots/Ctracks	037	237	637	037	237	637	037	237	637
Wire diameter 0.75 mm ²	Jacket Color				Jacket Color			Jacket Color																																												
	yellow	gray	black	yellow	gray	black	yellow	gray	black																																											
PVC	017	217	617	017	217	617	017	217	617																																											
PUR/PVC (UL/CSA)	027	227	627	027	227	627	027	227	627																																											
PUR (UL/CSA), robots/Ctracks	037	237	637	037	237	637	037	237	637																																											
3 Cable Length	<table border="1"> <tbody> <tr> <td>1.5 m</td> <td>0150</td> </tr> <tr> <td>3.0 m</td> <td>0300</td> </tr> <tr> <td>5.0 m</td> <td>0500</td> </tr> <tr> <td>7.5 m</td> <td>0750</td> </tr> <tr> <td>10.0 m</td> <td>1000</td> </tr> </tbody> </table>			1.5 m	0150	3.0 m	0300	5.0 m	0500	7.5 m	0750	10.0 m	1000																																							
1.5 m	0150																																																			
3.0 m	0300																																																			
5.0 m	0500																																																			
7.5 m	0750																																																			
10.0 m	1000																																																			
Technical Data	<table border="1"> <tbody> <tr> <td>Operating voltage</td> <td colspan="3">24 V AC ±20% / DC ±25%</td> </tr> <tr> <td>Protection</td> <td colspan="3">IP67 inserted and tightened (EN 60529)</td> </tr> <tr> <td>Temperature range</td> <td colspan="3">-25...+85 °C, depending on cable quality</td> </tr> </tbody> </table>			Operating voltage	24 V AC ±20% / DC ±25%			Protection	IP67 inserted and tightened (EN 60529)			Temperature range	-25...+85 °C, depending on cable quality																																							
Operating voltage	24 V AC ±20% / DC ±25%																																																			
Protection	IP67 inserted and tightened (EN 60529)																																																			
Temperature range	-25...+85 °C, depending on cable quality																																																			
Article No.	<p>The composition of your article number is explained on page 3.1.i</p> <p style="text-align: center;">7 0 0 0 - - - - -</p>																																																			
	1 Form	2 Cable Type	3 Cable Length																																																	
Notes	Other versions on request. Differing cable lengths up to 2 m can be ordered in 0.2 m steps, from 2 m on in 0.5 m steps.																																																			

Valve Connectors

VALVE CONNECTORS

MSUD - MSUD

– Double valve plugs with connection cable

Form B (10 mm)



Approvals: 

* only for products with UL/CSA approved cable

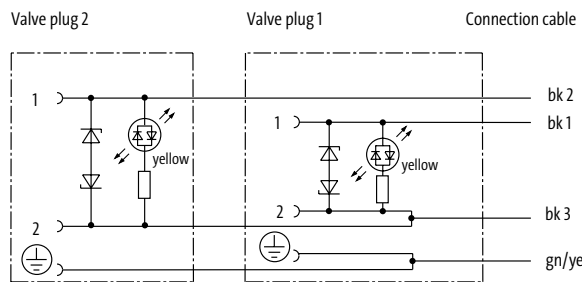
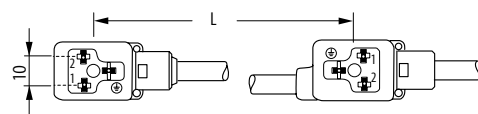
1 Form	58201	58221	58241																																																	
	24 V AC ±20% / DC ±25%	24 V AC ±20% / DC ±25%	24 V AC ±20% / DC ±25%																																																	
	LED and suppression L = 100 mm	LED and suppression L = 150 mm	LED and suppression L = 200 mm																																																	
Circuit diagram																																																				
Contact layout																																																				
2 Cable Type	<table border="1"> <thead> <tr> <th rowspan="2">Wire diameter 0.75 mm²</th> <th colspan="3">Jacket Color</th> <th colspan="3">Jacket Color</th> <th colspan="3">Jacket Color</th> </tr> <tr> <th>yellow</th> <th>gray</th> <th>black</th> <th>yellow</th> <th>gray</th> <th>black</th> <th>yellow</th> <th>gray</th> <th>black</th> </tr> </thead> <tbody> <tr> <td>PVC</td> <td>017</td> <td>217</td> <td>617</td> <td>017</td> <td>217</td> <td>617</td> <td>017</td> <td>217</td> <td>617</td> </tr> <tr> <td>PUR/PVC (UL/CSA)</td> <td>027</td> <td>227</td> <td>627</td> <td>027</td> <td>227</td> <td>627</td> <td>027</td> <td>227</td> <td>627</td> </tr> <tr> <td>PUR (UL/CSA), robots/Ctracks</td> <td>037</td> <td>237</td> <td>637</td> <td>037</td> <td>237</td> <td>637</td> <td>037</td> <td>237</td> <td>637</td> </tr> </tbody> </table>			Wire diameter 0.75 mm ²	Jacket Color			Jacket Color			Jacket Color			yellow	gray	black	yellow	gray	black	yellow	gray	black	PVC	017	217	617	017	217	617	017	217	617	PUR/PVC (UL/CSA)	027	227	627	027	227	627	027	227	627	PUR (UL/CSA), robots/Ctracks	037	237	637	037	237	637	037	237	637
Wire diameter 0.75 mm ²	Jacket Color				Jacket Color			Jacket Color																																												
	yellow	gray	black	yellow	gray	black	yellow	gray	black																																											
PVC	017	217	617	017	217	617	017	217	617																																											
PUR/PVC (UL/CSA)	027	227	627	027	227	627	027	227	627																																											
PUR (UL/CSA), robots/Ctracks	037	237	637	037	237	637	037	237	637																																											
3 Cable Length	<table border="1"> <tr><td>1.5 m</td><td>0150</td></tr> <tr><td>3.0 m</td><td>0300</td></tr> <tr><td>5.0 m</td><td>0500</td></tr> <tr><td>7.5 m</td><td>0750</td></tr> <tr><td>10.0 m</td><td>1000</td></tr> </table>			1.5 m	0150	3.0 m	0300	5.0 m	0500	7.5 m	0750	10.0 m	1000																																							
1.5 m	0150																																																			
3.0 m	0300																																																			
5.0 m	0500																																																			
7.5 m	0750																																																			
10.0 m	1000																																																			
Technical Data	<table border="1"> <tr><td>Operating voltage</td><td>24 V AC ±20% / DC ±25%</td></tr> <tr><td>Protection</td><td>IP67 inserted and tightened (EN 60529)</td></tr> <tr><td>Temperature range</td><td>-25...+85 °C, depending on cable quality</td></tr> </table>			Operating voltage	24 V AC ±20% / DC ±25%	Protection	IP67 inserted and tightened (EN 60529)	Temperature range	-25...+85 °C, depending on cable quality																																											
Operating voltage	24 V AC ±20% / DC ±25%																																																			
Protection	IP67 inserted and tightened (EN 60529)																																																			
Temperature range	-25...+85 °C, depending on cable quality																																																			
Article No.	<p>The composition of your article number is explained on page 3.1.i</p> <p style="text-align: center;">7 0 0 0 - - - - -</p>																																																			
Notes	<p>Other versions on request. Differing cable lengths up to 2 m can be ordered in 0.2 m steps, from 2 m on in 0.5 m steps.</p>																																																			
	1 Form	2 Cable Type	3 Cable Length																																																	

VALVE CONNECTORS

MSUD - MSUD

– Double valve plugs with connection cable

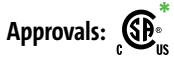

* only for products with UL/CSA approved cable

Form BI (11 mm)



1 Form	58101	58121	58141	
	Type	24 V AC ±20% / DC ±25%	24 V AC ±20% / DC ±25%	24 V AC ±20% / DC ±25%
	LED and suppression	LED and suppression	LED and suppression	LED and suppression
	L = 100 mm	L = 150 mm	L = 200 mm	
Circuit diagram				
Contact layout				
2 Cable Type	Jacket Color	Jacket Color	Jacket Color	
Wire diameter 0.75 mm ²	yellow gray black	yellow gray black	yellow gray black	
PVC	017 217 617	017 217 617	017 217 617	
PUR/PVC (UL/CSA)	027 227 627	027 227 627	027 227 627	
PUR (UL/CSA), robots/Ctracks	037 237 637	037 237 637	037 237 637	
3 Cable Length				
1.5 m	0150			
3.0 m	0300			
5.0 m	0500			
7.5 m	0750			
10.0 m	1000			
Technical Data				
Operating voltage	24 V AC ±20% / DC ±25%			
Protection	IP67 inserted and tightened (EN 60529)			
Temperature range	-25...+85 °C, depending on cable quality			
Article No.				
The composition of your article number is explained on page 3.1.i	<div style="display: flex; justify-content: space-around; align-items: center;"> 7 0 0 0 - - </div>			
	1 Form	2 Cable Type	3 Cable Length	
Notes	Other versions on request. Differing cable lengths up to 2 m can be ordered in 0.2 m steps, from 2 m on in 0.5 m steps.			

Valve Connectors

VALVE CONNECTORS

MSUD - MSUD

– Double valve plugs with connection cable

Form C (8 mm)



1 Form	58401	58411	58421
Type	24 V AC ±20% / DC ±25%	24 V AC ±20% / DC ±25%	24 V AC ±20% / DC ±25%
LED and suppression	LED and suppression	LED and suppression	LED and suppression
L = 110 mm	L = 110 mm	L = 150 mm	L = 200 mm
Circuit diagram			
Contact layout			
2 Cable Type	Jacket Color	Jacket Color	Jacket Color
Wire diameter 0.75 mm ²	yellow gray black	yellow gray black	yellow gray black
PVC	017 217 617	017 217 617	017 217 617
PUR/PVC (UL/CSA)	027 217 627	027 217 627	027 217 627
3 Cable Length			
1.5 m	0150		
3.0 m	0300		
5.0 m	0500		
7.5 m	0750		
10.0 m	1000		
Technical Data			
Operating voltage	24 V AC ±20% / DC ±25%		
Protection	IP67 inserted and tightened (EN 60529)		
Temperature range	-25...+85 °C, depending on cable quality		
Article No.			
The composition of your article number is explained on page 3.1.i	<div style="display: flex; justify-content: space-around; align-items: center;"> 7 0 0 0 - - </div>		
	1	2	3
	Form	Cable Type	Cable Length
Notes	Other versions on request. Differing cable lengths up to 2 m can be ordered in 0.2 m steps, from 2 m on in 0.5 m steps.		

VALVE CONNECTORS

MSUD - MSUD

– Double valve plugs with connection cable

Form CI (9.4 mm)

Industrial standard

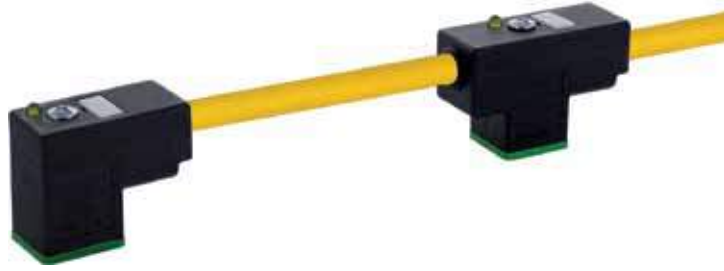

1 Form	58431	58441	58451						
Type	24 V AC ±20% / DC ±25%	24 V AC ±20% / DC ±25%	24 V AC ±20% / DC ±25%						
LED and suppression		LED and suppression	LED and suppression						
L = 110 mm		L = 150 mm	L = 200 mm						
Circuit diagram									
Contact layout									
2 Cable Type	Jacket Color								
Wire diameter 0.75 mm ²	yellow	gray	black	yellow	gray	black	yellow	gray	black
PVC	017	217	617	017	217	617	017	217	617
PUR/PVC (UL/CSA)	027		627	027		627	027		627
3 Cable Length									
1.5 m	0150								
3.0 m	0300								
5.0 m	0500								
7.5 m	0750								
10.0 m	1000								
Technical Data									
Operating voltage	24 V AC ±20% / DC ±25%								
Protection	IP67 inserted and tightened (EN 60529)								
Temperature range	-25...+85 °C, depending on cable quality								
Article No.									
The composition of your article number is explained on page 3.1.i	<div style="display: flex; justify-content: space-around; align-items: center;"> 7 0 0 0 - - </div>								
	1 Form			2 Cable Type			3 Cable Length		
Notes	Other versions on request. Differing cable lengths up to 2 m can be ordered in 0.2 m steps, from 2 m on in 0.5 m steps.								

Valve Connectors

VALVE CONNECTORS

MSUD - MSUD

– Double valve plugs with M12 male, connector top entry

Form A (18 mm)



Approvals: 

* only for products with UL/CSA approved cable

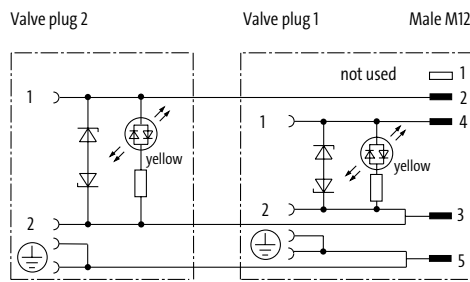
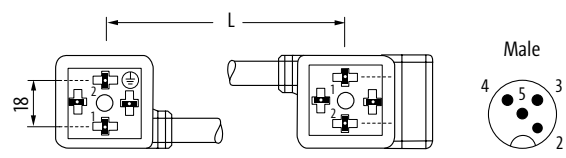
1 Form	41501	41521	41541							
Type	24 V AC ±20% / DC ±25%	24 V AC ±20% / DC ±25%	24 V AC ±20% / DC ±25%							
LED and suppression	LED and suppression	LED and suppression	LED and suppression							
L = 110 mm	L = 150 mm	L = 200 mm								
Circuit diagram										
Contact layout										
2 Cable Type	Jacket Color									
Wire diameter 0.75 mm ²	yellow	gray	black	yellow	gray	black	yellow	gray	black	
PVC	016	216	616	016	216	616	016	216	616	
PUR/PVC (UL/CSA)	026	226	626	026	226	626	026	226	626	
PUR (UL/CSA), robots/C-tracks	036	236	636	036	236	636	036	236	636	
Technical Data										
Operating voltage	24 V AC ±20% / DC ±25%									
Protection	IP67 inserted and tightened (EN 60529)									
Temperature range	-25...+85 °C, depending on cable quality									
Article No.										
The composition of your article number is explained on page 3.1.i	<u>7 0 0 0</u>			-	-			<u>0 0 0 0</u>		
	1 Form			2 Cable Type						
Notes	Other versions on request.									

VALVE CONNECTORS

MSUD - MSUD

– Double valve plugs with M12 male, connector at the rear

Form A (18 mm)



Approvals: 

* only for products with UL/CSA approved cable

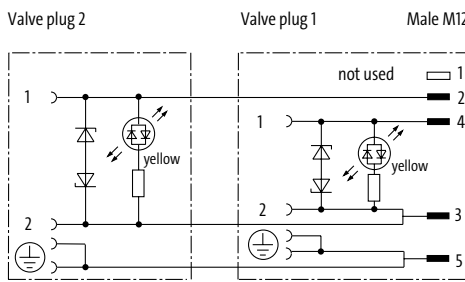
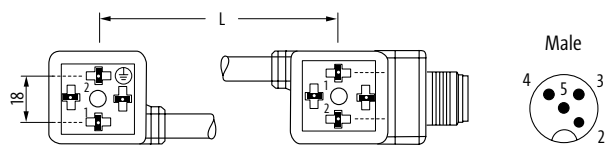
1 Form	41561	41581	41601						
	Type	24 V AC ±20% / DC ±25%	24 V AC ±20% / DC ±25%	24 V AC ±20% / DC ±25%					
	LED and suppression	LED and suppression	LED and suppression						
	L = 110 mm	L = 150 mm	L = 200 mm						
Circuit diagram									
Contact layout									
2 Cable Type	Jacket Color		Jacket Color		Jacket Color				
Wire diameter 0.75 mm ²	yellow	gray	black	yellow	gray	black	yellow	gray	black
PVC	016	216	616	016	216	616	016	216	616
PUR/PVC (UL/CSA)	026	226	626	026	226	626	026	226	626
PUR (UL/CSA), robots/C-tracks	036	236	636	036	236	636	036	236	636
Technical Data									
Operating voltage	24 V AC ±20% / DC ±25%								
Protection	IP67 inserted and tightened (EN 60529)								
Temperature range	-25...+85 °C, depending on cable quality								
Article No.									
The composition of your article number is explained on page 3.1.i	<u>7 0 0 0</u>		-	-		-	<u>0 0 0 0</u>		
	1 Form			2 Cable Type					
Notes	Other versions on request.								

VALVE CONNECTORS

MSUD - M12

– Connection cables

Form A (18 mm)



Male M12

straight

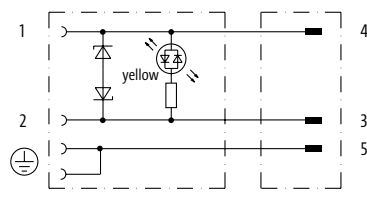
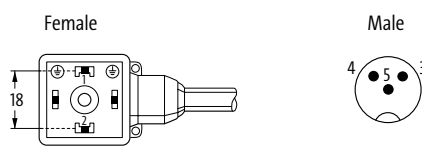

Approvals: 

* only for products with UL/CSA approved cable

1 Form		40881		
Type	24 V AC ±20% / DC ±25%			
Circuit diagram	<p>LED and suppression</p> 			
Contact layout	<div style="display: flex; justify-content: space-around;"> <div style="text-align: center;"> <p>Female</p>  </div> <div style="text-align: center;"> <p>Male</p>  </div> </div>			
2 Cable Type		Jacket Color		
Wire diameter 0.75 mm ²	yellow	gray	black	
PVC	016	216	616	
PUR/PVC (UL/CSA)	026	226	626	
PUR (UL/CSA), robots/C-tracks	036	236	636	
PUR (UL/CSA), welding spark	056	256	656	
3 Cable Length				
0.3 m	0030			
0.6 m	0060			
1.0 m	0100			
1.5 m	0150			
2.0 m	0200			
Technical Data				
Operating voltage	24 V AC ±20% / DC ±25%			
Protection	IP67 inserted and tightened (EN 60529)			
Temperature range	-25...+85 °C, depending on cable quality			
Article No.				
The composition of your article number is explained on page 3.1.i		7 0 0 0	- 4 0 8 8 1	- - -
		1 Form	2 Cable Type	3 Cable Length
Notes		Other versions on request. Differing cable lengths up to 2 m can be ordered in 0.2 m steps, from 2 m on in 0.5 m steps.		

VALVE CONNECTORS

MSUD - M12

- Connection cables
- for pressure switches

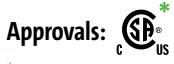

* only for products with UL/CSA approved cable

Form A (18 mm)

Male M12
straight



1 Form		40921			40931		
Type	24 V DC ±25%	LED (red/green)			24 V DC ±25%		
Circuit diagram							
Contact layout							
2 Cable Type		Jacket Color			Jacket Color		
Wire diameter 0.34 mm ²	yellow	gray	black	yellow	gray	black	
PVC (UL/CSA)	015	215 (219)	615 (619)	015	215 (219)	615 (619)	
PUR/PVC (UL/CSA)	025	225	625	025	225	625	
PUR (UL/CSA), robots/C-tracks	035	235	635	035	235	635	
PUR (UL/CSA), welding spark	055	255	655	055	255	655	
3 Cable Length							
0.3 m	0030						
0.6 m	0060						
1.0 m	0100						
1.5 m	0150						
2.0 m	0200						
Technical Data							
Operating voltage	24 V DC ±25%						
Protection	IP67 inserted and tightened (EN 60529)						
Temperature range	-25...+85 °C, depending on cable quality						
Article No.							
The composition of your article number is explained on page 3.1.i	<div style="display: flex; justify-content: space-around; align-items: center;"> 7 0 0 0 - - </div>						
	1	2	3				
	Form	Cable Type	Cable Length				
Notes		Other versions on request. Differing cable lengths up to 2 m can be ordered in 0.2 m steps, from 2 m on in 0.5 m steps.					

Valve Connectors

VALVE CONNECTORS

MSUD - M12

– Connection cables

Form B (10 mm)

Male M12
straight

Form BI (11 mm)

Industrial standard

Male M12
straight



Approvals: 

* only for products with UL/CSA approved cable

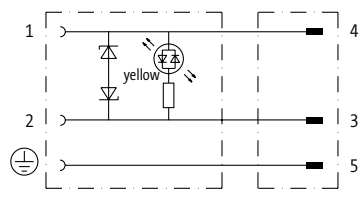
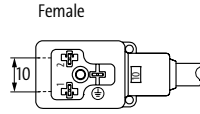
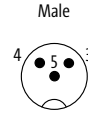
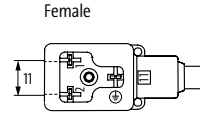
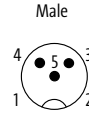
1 Form	41001	40961
Type	24 V AC ±20% / DC ±25%	24 V AC ±20% / DC ±25%
Circuit diagram		
Contact layout	<p>Female</p>  <p>Male</p> 	<p>Female</p>  <p>Male</p> 
2 Cable Type	Jacket Color	Jacket Color
Wire diameter 0.75 mm ²	yellow gray black	yellow gray black
PVC	016 216 616	016 216 616
PUR/PVC (UL/CSA)	026 226 626	026 226 626
PUR (UL/CSA), robots/C-tracks	036 236 636	036 236 636
PUR (UL/CSA), welding spark	056 256 656	056 256 656
3 Cable Length		
0.3 m	0030	
0.6 m	0060	
1.0 m	0100	
1.5 m	0150	
2.0 m	0200	
Technical Data		
Operating voltage	24 V AC ±20% / DC ±25%	
Protection	IP67 inserted and tightened (EN 60529)	
Temperature range	-25...+85 °C, depending on cable quality	
Article No.		
The composition of your article number is explained on page 3.1.i	7 0 0 0 - - - -	
	1 Form	2 Cable Type
		3 Cable Length
Notes		
	Other versions on request. Differing cable lengths up to 2 m can be ordered in 0.2 m steps, from 2 m on in 0.5 m steps.	

VALVE CONNECTORS

MSUD - M12

– Connection cables

Form C (8 mm)

Male M12
straight



Form CI (9.4 mm)
Industrial standard

Male M12
straight

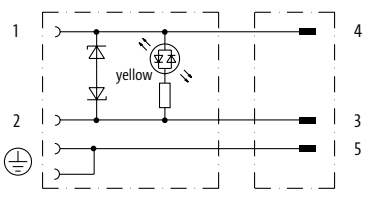
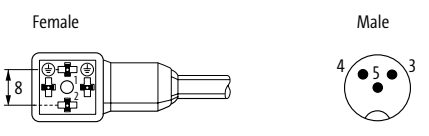

Approvals: 

* only for products with UL/CSA approved cable

1 Form		41081			41041		
Type	24 V AC ±20% / DC ±25%	LED and suppression			LED and suppression		
Circuit diagram							
Contact layout							
2 Cable Type		Jacket Color			Jacket Color		
Wire diameter 0.75 mm ²	yellow	gray	black	yellow	gray	black	
PVC	016	216	616	016	216	616	
PUR/PVC (UL/CSA)	026	226	626	026	226	626	
PUR (UL/CSA), robots/C-tracks	036	236	636	036	236	636	
PUR (UL/CSA), welding spark	056	256	656	056	256	656	
3 Cable Length							
0.3 m	0030						
0.6 m	0060						
1.0 m	0100						
1.5 m	0150						
2.0 m	0200						
Technical Data							
Operating voltage	24 V AC ±20% / DC ±25%						
Protection	IP67 inserted and tightened (EN 60529)						
Temperature range	-25...+85 °C, depending on cable quality						
Article No.							
The composition of your article number is explained on page 3.1.i	<div style="display: flex; justify-content: space-around; align-items: center;"> 7 0 0 0 - _ _ _ - _ _ _ </div>						
	1	2	3				
	Form	Cable Type	Cable Length				
Notes		Other versions on request. Differing cable lengths up to 2 m can be ordered in 0.2 m steps, from 2 m on in 0.5 m steps.					

VALVE CONNECTORS

MSUD - M12

– Adapter

Approvals: 

Form A (18 mm)

Top connection



Form A (18 mm)

Rear connection

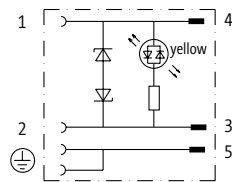
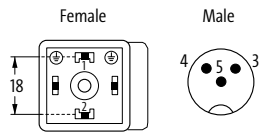
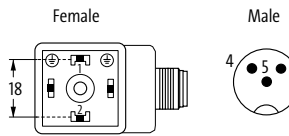

1 Form	41301	41421
Type	24 V AC ±20% / DC ±25% M12, 3-pole LED and suppression	24 V AC ±20% / DC ±25% M12, 3-pole LED and suppression
Circuit diagram		
Contact layout		
Technical Data		
Operating voltage	24 V AC ±20% / DC ±25%	
Rated surge voltage	0.8 kV	
Operating current per contact	max. 4 A	
Configuration	2 contacts + bridged PE	
Locking of ports	M3/M12 × 1 mm (recommended torque 0.4/0.6 Nm)	
Protection	IP67 inserted and tightened (EN 60529)	
Temperature range	-25...+85 °C	
Article No.		
The composition of your article number is explained on page 3.1.i	<p style="text-align: center;"><u>7 0 0 0</u> - <u> </u> - <u>0 0 0</u> <u>0 0 0 0</u></p>	
	1 Form	
Notes	Other versions on request.	

VALVE CONNECTORS

MSUD - M12

– Adapter

Approvals: 

Form BI (11 mm)

Industrial standard
Top connection



Form BI (11 mm)

Industrial standard
Rear connection



1 Form

42021

42081

Type	24 V AC ±20% / DC ±25%	24 V AC ±20% / DC ±25%
	M12, 3-pole	M12, 3-pole
	LED and suppression	LED and suppression

Circuit diagram

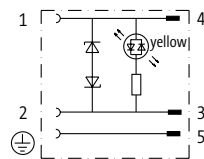

Contact layout

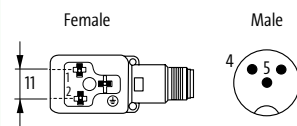
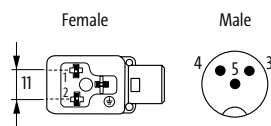

Technical Data

Operating voltage	24 V AC ±20% / DC ±25%
Rated surge voltage	0.8 kV
Operating current per contact	max. 4 A
Configuration	2 contacts + PE
Locking of ports	M3/M12 × 1 mm (recommended torque 0.4/0.6 Nm)
Protection	IP67 inserted and tightened (EN 60529)
Temperature range	-25...+85 °C

Article No.

The composition of your article number is explained on page 3.1.i

7 0 0 0 - - - - - - - 0 0 0 0 0 0 0

1 Form

Notes

Other versions on request.

VALVE CONNECTORS

SVS

- Field-wireable
- Convenient connection, screw terminals

Form A (18 mm)



1 Form	29001	29021	29041	29061
Type	24 V AC ±20% / DC ±25%	24 V AC ±20% / DC ±25%	max. 24 V AC/DC	max. 24 V AC/DC
LED and Z-diode		LED and Z-diode	LED and RC	LED and RC
	metric	PG9	metric	PG9
Circuit diagram				
Contact figure	Cable outlet can be turned in 90° steps			
Contact layout				
Technical Data				
Operating voltage	24 V AC ±20% / DC ±25%		max. 24 V AC/DC	
Operating current per contact	max. 4 A		max. 2 A	
Configuration	2 contacts + PE			
Locking of ports	M3 (recommended torque 0.4 Nm)			
Protection	IP65 inserted and tightened (EN 60529)			
Temperature range	-20...+60 °C			
Article No.				
The composition of your article number is explained on page 3.1.i	<div style="display: flex; justify-content: space-around; align-items: center;"> <u>7</u> <u>0</u> <u>0</u> <u>0</u> - _____ - <u>0</u> <u>0</u> <u>0</u> <u>0</u> <u>0</u> <u>0</u> <u>0</u> </div>			
	1 Form			
Notes	Other versions on request.			

VALVE CONNECTORS

SVS

- Field-wireable
- Convenient connection, screw terminals

Form A (18 mm)



1 Form	29081	29101	29241	29261
Type	max. 110 V AC/DC	max. 110 V AC/DC	max. 230 V AC/DC	max. 230 V AC/DC
LED and VDR		LED and VDR	without components	without components
metric		PG9	metric	PG9
Circuit diagram				
Contact figure	Cable outlet can be turned in 90° steps			
Contact layout				
Technical Data				
Operating voltage	max. 110 V AC/DC		max. 230 V AC/DC	
Operating current per contact	max. 1 A		max. 10 A	
Configuration	2 contacts + PE			
Locking of ports	M3 (recommended torque 0.4 Nm)			
Protection	IP65 inserted and tightened (EN 60529)			
Temperature range	-20...+60 °C			
Article No.				
The composition of your article number is explained on page 3.1.i	7 0 0 0		0 0 0	
	1 Form			
Notes	Other versions on request.			

Valve Connectors

VALVE CONNECTORS

SVS

- Field-wireable
- Convenient connection, screw terminals

Form A (18 mm)



1 Form	29161	29181	29121	29141
Type	max. 230 V AC/DC	max. 230 V AC/DC	110 V AC/DC and 230 V AC/DC	110 V AC/DC and 230 V AC/DC
	LED and VDR	LED and VDR	LED and RC	LED and RC
	metric	PG9	metric	PG9
Circuit diagram				
Contact figure	Cable outlet can be turned in 90° steps			
Contact layout				
Technical Data				
Operating voltage	max. 230 V AC/DC		110 V AC/DC and 230 V AC/DC	
Operating current per contact	max. 1 A			
Configuration	2 contacts + PE			
Locking of ports	M3 (recommended torque 0.4 Nm)			
Protection	IP65 inserted and tightened (EN 60529)			
Temperature range	-20...+60 °C			
Article No.				
The composition of your article number is explained on page 3.1.i	<div style="display: flex; justify-content: space-around; align-items: center;"> <u>7</u> <u>0</u> <u>0</u> <u>0</u> - _____ - <u>0</u> <u>0</u> <u>0</u> <u>0</u> <u>0</u> <u>0</u> <u>0</u> </div>			
	1 Form			
Notes	Other versions on request.			

VALVE CONNECTORS

SVS

- Field-wireable
- Convenient connection, screw terminals

Form A (18 mm)



1 Form	29481	29501	29521	29541
Type	12...30 V DC	12...30 V DC	24...230 V AC/DC	24...230 V AC/DC
	LED and switching amplifier	LED and switching amplifier	LED and bridge rectifier	LED and bridge rectifier
	metric	PG9	metric	PG9

Circuit diagram

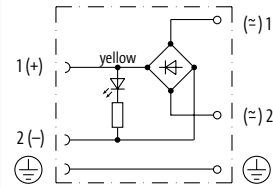
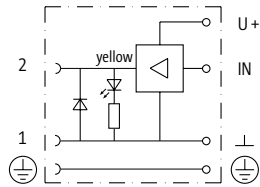

Contact figure

Cable outlet can be turned in 90° steps

Contact layout

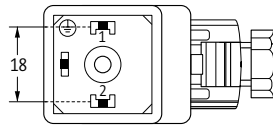

Technical Data

Operating voltage	12...30 V DC	24...230 V AC/DC
Operating current per contact	max. 2 A (short-circuit protected)	max. 1 A
Configuration	2 contacts + PE	
Locking of ports	M3 (recommended torque 0.4 Nm)	
Protection	IP65 inserted and tightened (EN 60529)	
Temperature range	-20...+60 °C	

Article No.

The composition of your article number is explained on page 3.1.i

7 0 0 0

-

0 0 0

0 0 0 0

1 Form

Notes

Other versions on request.

VALVE CONNECTORS

SVS

- Field-wireable
- Convenient connection, screw terminals
- for pressure switches

Form A (18 mm)



1 Form	29281	29301	29441	29461
Type	24...230 V AC/DC	24...230 V AC/DC	max. 24 V AC/DC	max. 24 V AC/DC
	LED red (2) green (3)	LED red (2) green (3)	LED green (1) yellow (3)	LED green (1) yellow (3)
	metric	PG9	metric	PG9
Circuit diagram				
Contact figure	Cable outlet can be turned in 90° steps			
Contact layout				
Technical Data				
Operating voltage	24...230 V AC/DC		max. 24 V AC/DC	
Operating current per contact	max. 4 A			
Configuration	3 contacts + PE			
Locking of ports	M3 (recommended torque 0.4 Nm)			
Protection	IP65 inserted and tightened (EN 60529)			
Temperature range	-20...+60 °C			
Article No.				
The composition of your article number is explained on page 3.1.i	<div style="display: flex; justify-content: space-around; align-items: center;"> <u>7</u> <u>0</u> <u>0</u> <u>0</u> - _____ - <u>0</u> <u>0</u> <u>0</u> <u>0</u> <u>0</u> <u>0</u> <u>0</u> </div>			
	1 Form			
Notes	Other versions on request.			

VALVE CONNECTORS

SVS

- Field-wireable
- Convenient connection, screw terminals
- for pressure switches

Form A (18 mm)



1 Form	29361	29381	29401	29421
Type	24...230 V AC/DC	24...230 V AC/DC	max. 230 V AC/DC	max. 230 V AC/DC
	LED yellow (3)	LED yellow (3)	without components	without components
	metric	PG9	metric	PG9
Circuit diagram				
Contact figure	Cable outlet can be turned in 90° steps			
Contact layout				
Technical Data				
Operating voltage	24...230 V AC/DC		max. 230 V AC/DC	
Operating current per contact	max. 4 A		max. 10 A	
Configuration	3 contacts + PE			
Locking of ports	M3 (recommended torque 0.4 Nm)			
Protection	IP65 inserted and tightened (EN 60529)			
Temperature range	-20...+60 °C			
Article No.				
The composition of your article number is explained on page 3.1.i	<div style="display: flex; justify-content: space-around; align-items: center;"> <u>7 0 0 0</u> - _____ - <u>0 0 0</u> <u>0 0 0 0</u> </div>			
	1 Form			
Notes	Other versions on request.			

Valve Connectors

VALVE CONNECTORS

SVS

- Field-wireable
- Convenient connection, screw terminals

Form B (10 mm)



1 Form	29561	29581	29601	29621
Type	24 V AC ±20% / DC ±25%	24 V AC ±20% / DC ±25%	max. 24 V AC/DC	max. 24 V AC/DC
LED and Z-diode		LED and Z-diode	LED and RC	LED and RC
	metric	PG9	metric	PG9
Circuit diagram				
Contact figure	Cable outlet can be turned in 180° steps			
Contact layout				
Technical Data				
Operating voltage	24 V AC ±20% / DC ±25%		max. 24 V AC/DC	
Operating current per contact	max. 4 A		max. 2 A	
Configuration	2 contacts + PE			
Locking of ports	M3 (recommended torque 0.4 Nm)			
Protection	IP65 inserted and tightened (EN 60529)			
Temperature range	-20...+60 °C			
Article No.				
The composition of your article number is explained on page 3.1.i	<div style="display: flex; justify-content: space-around; align-items: center;"> <u>7</u> <u>0</u> <u>0</u> <u>0</u> - _____ - <u>0</u> <u>0</u> <u>0</u> _____ <u>0</u> <u>0</u> <u>0</u> <u>0</u> </div>			
	1 Form			
Notes	Other versions on request.			

VALVE CONNECTORS

SVS

- Field-wireable
- Convenient connection, screw terminals

Form BI (11 mm)

Industrial standard



1 Form	29801	29821	29841	29861
Type	24 V AC $\pm 20\%$ / DC $\pm 25\%$	24 V AC $\pm 20\%$ / DC $\pm 25\%$	max. 24 V AC/DC	max. 24 V AC/DC
LED and Z-diode		LED and Z-diode	LED and RC	LED and RC
metric		PG9	metric	PG9
Circuit diagram				
Contact figure	Cable outlet can be turned in 180° steps			
Contact layout				
Technical Data				
Operating voltage	24 V AC $\pm 20\%$ / DC $\pm 25\%$		max. 24 V AC/DC	
Operating current per contact	max. 4 A		max. 2 A	
Configuration	2 contacts + PE			
Locking of ports	M3 (recommended torque 0.4 Nm)			
Protection	IP65 inserted and tightened (EN 60529)			
Temperature range	-20...+60 °C			
Article No.				
The composition of your article number is explained on page 3.1.i	<div style="display: flex; justify-content: space-around; align-items: center;"> <u>7 0 0 0</u> - _____ - <u>0 0 0</u> <u>0 0 0 0</u> </div>			
	1 Form			
Notes	Other versions on request.			

VALVE CONNECTORS

MOSA

– Field-wireable

– IDC terminals

Form C (8 mm)



Form CI (9.4 mm)

Industrial standard



1 Form	80081	94081
Type	24 V AC/DC ±25%	24 V AC/DC ±25%
	LED and suppression	LED and suppression
Circuit diagram		
Contact figure	Cable outlet can be turned in 90° steps	
Contact layout		
Technical Data		
Operating voltage	24 V AC/DC ±25%	
Operating current per contact	max. 3 A	
Configuration	3 contacts + PE	
Contact figure	Cable outlet can be turned in 3 × 90° steps	
Protection	IP65 inserted and tightened (EN 60529)	
Temperature range	-25...+85 °C	
Article No.		
The composition of your article number is explained on page 3.1.i	7 0 0 0 - - 0 0 0 0	
	1 Form	
Notes	Other versions on request.	

VALVE CONNECTORS

SVS Eco

- Field-wireable
- Screw terminals
- without components

Form A (18 mm)



Form A (18 mm)

for pressure switches



1 Form

29245

29405

Type	max. 250 V AC/DC without components metric	max. 250 V AC/DC without components metric
------	--	--

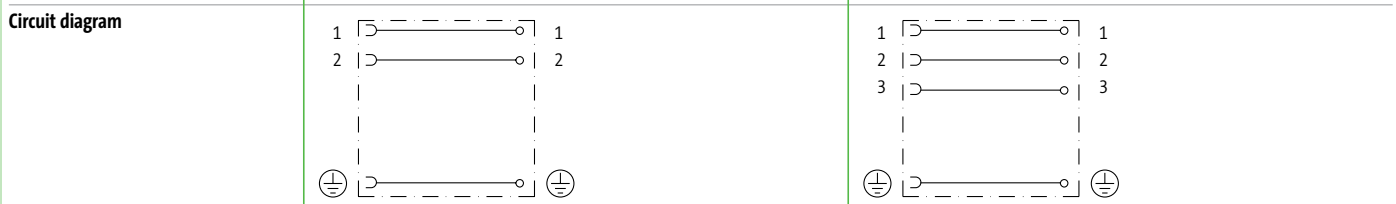

Contact figure Cable outlet can be turned in 90° steps

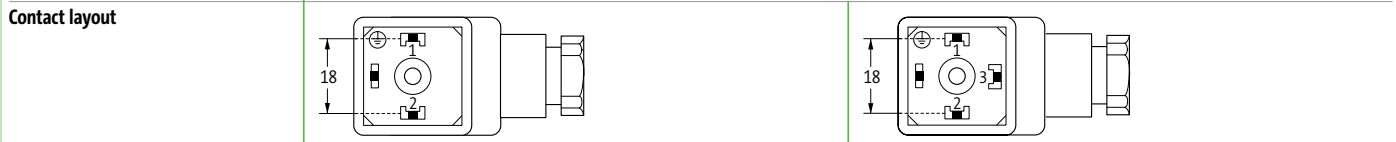

Technical Data

Operating voltage	max. 250 V AC/DC
Operating current per contact	max. 10 A
Configuration	2 contacts + PE 3 contacts + PE
Locking of ports	M3 (recommended torque 0.4 Nm)
Contact figure	Cable outlet can be turned in 90° steps
Protection	IP65 inserted and tightened (EN 60529)
Temperature range	-40...+90 °C

Article No.

The composition of your article number is explained on page 3.1.i

7 0 0 0 - - - - - 0 0 0 | 0 0 0 0

1 Form

Notes

Other versions on request.

VALVE CONNECTORS

SVS Eco

- Field-wireable
- Screw terminals
- without components

Form B (10 mm)



Form BI (11 mm)



1 Form	29765	30005
Type	max. 250 V AC/DC without components metric	max. 250 V AC/DC without components metric
Circuit diagram		
Contact figure Contact layout	<p>Cable outlet can be turned in 180° steps</p>	
Technical Data		
Operating voltage	max. 250 V AC/DC	
Operating current per contact	max. 10 A	
Configuration	2 contacts + PE	
Locking of ports	M3 (recommended torque 0.4 Nm)	
Contact figure	Cable outlet can be turned in 180° steps	
Protection	IP65 inserted and tightened (EN 60529)	
Temperature range	-40...+90 °C	
Article No.		
The composition of your article number is explained on page 3.1.i	7 0 0 0 - 0 0 0 - 0 0 0 0	
	1 Form	
Notes	Other versions on request.	

VALVE CONNECTORS

- SVS Eco
- Field-wireable
- Screw terminals
- without components

Form C (8 mm)



Form CI (9.4 mm)

Industrial standard



1 Form

30055

30155

Type	max. 250 V AC/DC without components metric	max. 250 V AC/DC without components metric
------	--	--

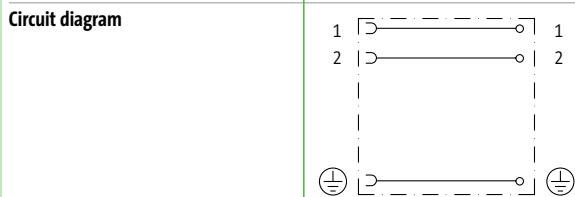

Contact figure
Contact layout

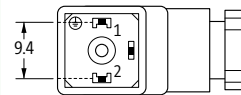
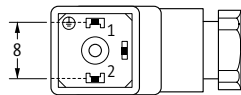

Technical Data

Operating voltage	max. 250 V AC/DC	
Operating current per contact	max. 6 A	
Configuration	2 contacts + PE	
Locking of ports	M2.5 (recommended torque 0.4 Nm)	M3 (recommended torque 0.4 Nm)
Contact figure	Cable outlet can be turned in 90° steps	
Protection	IP65 inserted and tightened (EN 60529)	
Temperature range	-40...+90 °C	

Article No.

The composition of your article number is explained on page 3.1.i

7 0 0 0 - - - - - - 0 0 0 0 0 0 0

1 Form

Notes

Other versions on request.

VALVE CONNECTORS

SVS Eco, LED

- Field-wireable
- Screw terminals

Form A (18 mm)



1 Form	29005	29085	29165
Type	24 V AC/DC ±10%	110 V AC/DC ±10%	230 V AC/DC
	LED and VDR metric	LED and VDR metric	LED and VDR metric
Circuit diagram			
Contact figure	Cable outlet can be turned in 90° steps		
Contact layout			
Technical Data			
Operating voltage	24 V AC/DC ±10%	110 V AC/DC ±10%	230 V AC/DC ±10%
Operating current per contact	max. 1.5 A		
Configuration	2 contacts + PE		
Locking of ports	M3 (recommended torque 0.4 Nm)		
Contact figure	Cable outlet can be turned in 90° steps		
Protection	IP65 inserted and tightened (EN 60529)		
Temperature range	-40...+60 °C		
Article No.			
The composition of your article number is explained on page 3.1.i	<u>7</u> <u>0</u> <u>0</u> <u>0</u>	-	<u>0</u> <u>0</u> <u>0</u>
	1	Form	
Notes	Other versions on request.		

VALVE CONNECTORS

SVS Eco, LED

– Field-wireable

– Screw terminals

Form B (10 mm)



1 Form	29565	29645	29685
Type	24 V AC/DC ±10%	110 V AC/DC ±10%	230 V AC/DC ±10%
	LED and VDR	LED and VDR	LED and VDR
	metric	metric	metric
Circuit diagram			
Contact figure	Cable outlet can be turned in 180° steps		
Contact layout			
Technical Data			
Operating voltage	24 V AC/DC ±10%	110 V AC/DC ±10%	230 V AC/DC ±10%
Operating current per contact	max. 1.5 A		
Configuration	2 contacts + PE		
Locking of ports	M3 (recommended torque 0.4 Nm)		
Contact figure	Cable outlet can be turned in 180° steps		
Protection	IP65 inserted and tightened (EN 60529)		
Temperature range	-40...+60 °C		
Article No.			
The composition of your article number is explained on page 3.1.i	<u>7</u> <u>0</u> <u>0</u> <u>0</u>	-	<u>0</u> <u>0</u> <u>0</u>
	1 Form		
Notes	Other versions on request.		

Valve Connectors

VALVE CONNECTORS

SVS Eco, LED

– Field-wireable

– Screw terminals

Form BI (11 mm)

Industrial standard



1 Form	29805	29885	29925
Type	24 V AC/DC ±10%	110 V AC/DC ±10%	230 V AC ±10%
	LED and VDR metric	LED and VDR metric	LED and VDR metric
Circuit diagram			
Contact figure	Cable outlet can be turned in 180° steps		
Contact layout			
Technical Data			
Operating voltage	24 V AC/DC ±10%	110 V AC/DC ±10%	230 V AC ±10%
Operating current per contact	max. 1.5 A		
Configuration	2 contacts + PE		
Locking of ports	M3 (recommended torque 0.4 Nm)		
Contact figure	Cable outlet can be turned in 180° steps		
Protection	IP65 inserted and tightened (EN 60529)		
Temperature range	-40...+60 °C		
Article No.			
The composition of your article number is explained on page 3.1.i	7 0 0 0 - 0 0 0 - 0 0 0 0		
	1 Form		
Notes	Other versions on request.		

VALVE CONNECTORS

SVS Eco, LED

– Field-wireable

– Screw terminals

Form C (8 mm)



1 Form	30105	30115	30125	
Type	24 V AC/DC ±10%	110 V AC/DC ±10%	230 V AC/DC ±10%	
	LED and VDR	LED and VDR	LED and VDR	
	metric	metric	metric	
Circuit diagram				
Contact figure	Cable outlet can be turned in 90° steps			
Contact layout				
Technical Data				
Operating voltage	24 V AC/DC ±10%	110 V AC/DC ±10%	230 V AC/DC ±10%	
Operating current per contact	max. 1.5 A			
Configuration	2 contacts + PE			
Locking of ports	M2.5 (recommended torque 0.4 Nm)			
Contact figure	Cable outlet can be turned in 90° steps			
Protection	IP65 inserted and tightened (EN 60529)			
Temperature range	-40...+60 °C			
Article No.				
The composition of your article number is explained on page 3.1.i	<u>7</u> <u>0</u> <u>0</u> <u>0</u>	-	-	<u>0</u> <u>0</u> <u>0</u>
	1 Form			
Notes	Other versions on request.			

Valve Connectors

SVS Eco, LED

– Field-wireable

– Screw terminals

Form CI (9.4 mm)

Industrial standard



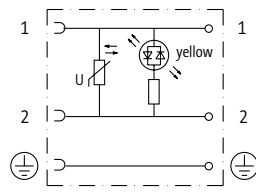
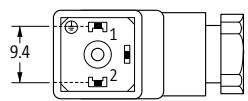

1 Form	30205	30215
Type	24 V AC/DC ±10%	110 V AC/DC ±10%
	LED and VDR metric	LED and VDR metric
Circuit diagram		
Contact figure	Cable outlet can be turned in 90° steps	
Contact layout		
Technical Data		
Operating voltage	24 V AC/DC ±10%	110 V AC/DC ±10%
Operating current per contact	max. 1.5 A	
Configuration	2 contacts + PE	
Locking of ports	M3 (recommended torque 0.4 Nm)	
Contact figure	Cable outlet can be turned in 90° steps	
Protection	IP65 inserted and tightened (EN 60529)	
Temperature range	-40...+60 °C	
Article No.		
The composition of your article number is explained on page 3.1.i	<p style="text-align: center;">7 0 0 0 - - 0 0 0 0 0 0 0</p>	
	1 Form	
Notes	Other versions on request.	

Valve Connectors

VALVE CONNECTORS

Labeling accessories			Art-No.
	ACS label plate (KM 5)		
	for self marking (9 × 20 mm)		7000-99001-000000
	for self marking with ADEMARK markers		7000-99003-000000
Gasket accessories			Art-No.
	Silicon gasket	Valve plug (form A)	7000-99011-000000
	Flat gasket, NBR	Valve plug (form A)	7000-99012-000000
	Silicon gasket	Valve plug (form B, BI)	7000-99013-000000
	Flat gasket, NBR	Valve plug (form B, BI)	7000-99014-000000
	Accessories set		
	Screw, isolation plate, label plate, flat gasket	Valve plug (form A)	7000-99015-000000
	Screw, isolation plate, label plate, flat gasket	Valve plug (form A), field wireable	7000-99016-000000
	Screw, isolation plate, label plate, flat gasket	Valve plug (form B, BI)	7000-99017-000000
	Screw, isolation plate, label plate, flat gasket	Valve plug (form B, BI), field wireable	7000-99018-000000
	Screw, isolation plate, label plate, flat gasket	Valve plug (form C)	7000-99019-000000
	Hexagonal screw		
	Metal	Valve plug (form A)	7000-99021-000000
	Metal	Valve plug (form A, B, BI), field wireable	7000-99022-000000
	Stainless Steel 1.4404 (V4A)	Valve plug (form A)	7000-99024-000000
	Plastic	Valve plug (form A)	7000-99023-000000
	Gasket for valve plug socket		
	2 contacts + PE and 3 contacts + PE	Valve plug (form A)	7000-99251-000000
	2 contacts + PE and 3 contacts + PE	Valve plug (form A)	7000-99255-000000
	FPM		
	2 contacts + PE	Valve plug (form B)	7000-99271-000000
	2 contacts + PE	Valve plug (form BI)	7000-99261-000000
2 contacts + PE and 3 contacts + PE	Valve plug (form C)	7000-99291-000000	
2 contacts + PE and 3 contacts + PE	Valve plug (form CI)	7000-99281-000000	
End fitting accessories			Art-No.
	Cable compression gland PG 9		
	(gray)	Valve plug (form A, B, BI), field wireable	7000-99025-000000
	(black)	Valve plug (form A, B, BI), field wireable	7000-99026-000000

VALVE CONNECTORS

End fitting accessories			Art-No.
	Tube adapter snap-in for corrugated tube (size 13mm)	Cable diameter (4...7 mm)	7000-99081-0000000
	Valve plug socket 2 contacts + PE 2 contacts + PE 2 contacts + PE 2 contacts + PE 2 contacts + PE	Valve plug (form A) Valve plug (form B) Valve plug (form B1) Valve plug (form C) Valve plug (form C1)	7000-99201-0000000 7000-99221-0000000 7000-99211-0000000 7000-99241-0000000 7000-99231-0000000
	Valve plug socket 3 contacts + PE 3 contacts + PE 3 contacts + PE	Valve plug (form A) Valve plug (form C) Valve plug (form C1)	7000-99205-0000000 7000-99245-0000000 7000-99235-0000000

Cables										
yellow	gray	black	No./diameter of wires	Wire isolation	C-track properties	Material (jacket)	Outer Ø	Bend radius (moving)	Temperature range (fixed)	Temperature range (mobile)
010	210	610	3 × 0.25 mm ²	PVC (br, bl, bk)		PVC (UL/CSA)	4.5 ±5%	10 × outer Ø	-30...+80 °C	-5...+80 °C
011	211	611	4 × 0.25 mm ²	PVC (br, wh, bl, bk)		PVC (UL/CSA)	4.8 ±5%	10 × outer Ø	-30...+80 °C	-5...+80 °C
013	213	613	3 × 0.34 mm ²	PVC (br, bl, bk)		PVC (UL/CSA)	4.6 ±5%	10 × outer Ø	-30...+80 °C	-5...+80 °C
014	214	614	4 × 0.34 mm ²	PVC (br, wh, bl, bk)		PVC (UL/CSA)	5.0 ±5%	10 × outer Ø	-30...+80 °C	-5...+80 °C
015	215	615	5 × 0.34 mm ²	PVC (br, wh, bl, bk, gnye)		PVC (UL/CSA)	5.2 ±5%	10 × outer Ø	-30...+80 °C	-5...+80 °C
-	219	619	5 × 0.34 mm ²	PVC (br, wh, bl, bk, gr)		PVC (UL/CSA)	5.2 ±5%	10 × outer Ø	-30...+80 °C	-5...+80 °C
015	215	615	5 × 0.34 mm ²	PVC (br, wh, bl, bk, gnye)		PVC (UL/CSA)	5.2 ±5%	10 × outer Ø	-30...+80 °C	-5...+80 °C
016	216	616	3 × 0.75 mm ²	PVC (bk num, gnye)		PVC	5.9 ±5%	10 × outer Ø	-30...+70 °C	-5...+70 °C
017	217	617	4 × 0.75 mm ²	PVC (bk num, gnye)		PVC	6.5 ±5%	10 × outer Ø	-30...+70 °C	-5...+70 °C
018	218	618	5 × 0.75 mm ²	PVC (bk num, gnye)		PVC	7.0 ±5%	10 × outer Ø	-30...+70 °C	-5...+70 °C
020	220	620	3 × 0.25 mm ²	PVC (br, bl, bk)	2 Mio.	PUR/PVC (UL/CSA)	4.5 ±5%	15 × outer Ø	-30...+80 °C	-5...+80 °C
021	221	621	4 × 0.25 mm ²	PVC (br, wh, bl, bk)	2 Mio.	PUR/PVC (UL/CSA)	4.8 ±5%	15 × outer Ø	-30...+80 °C	-5...+80 °C
023	223	623	3 × 0.34 mm ²	PVC (br, bl, bk)	2 Mio.	PUR/PVC (UL/CSA)	4.9 ±5%	15 × outer Ø	-30...+80 °C	-5...+80 °C
024	224	624	4 × 0.34 mm ²	PVC (br, wh, bl, bk)	2 Mio.	PUR/PVC (UL/CSA)	5.2 ±5%	15 × outer Ø	-30...+80 °C	-5...+80 °C
025	225	625	5 × 0.34 mm ²	PVC (br, wh, bl, bk, gnye)	2 Mio.	PUR/PVC (UL/CSA)	5.9 ±5%	15 × outer Ø	-30...+80 °C	-5...+80 °C
025	225	625	5 × 0.34 mm ²	PVC (br, wh, bl, bk, gnye)	2 Mio.	PUR/PVC (UL/CSA)	5.9 ±5%	15 × outer Ø	-30...+80 °C	-5...+80 °C
026	226	626	3 × 0.75 mm ²	PVC (bk num, gnye)	2 Mio.	PUR/PVC (UL/CSA)	5.9 ±5%	15 × outer Ø	-30...+80 °C	-5...+80 °C
027	227	627	4 × 0.75 mm ²	PVC (bk num, gnye)	2 Mio.	PUR/PVC (UL/CSA)	6.5 ±5%	15 × outer Ø	-30...+80 °C	-5...+80 °C
028	228	628	5 × 0.75 mm ²	PVC (bk num, gnye)	2 Mio.	PUR/PVC (UL/CSA)	7.0 ±5%	15 × outer Ø	-30...+80 °C	-5...+80 °C
030	230	630	3 × 0.25 mm ²	PP (br, bl, bk)	5 Mio.	PUR (UL/CSA)	4.3 ±5%	10 × outer Ø	-40...+80 °C	-25...+80 °C
031	231	631	4 × 0.25 mm ²	PP (br, wh, bl, bk)	5 Mio.	PUR (UL/CSA)	4.7 ±5%	10 × outer Ø	-40...+80 °C	-25...+80 °C
033	233	633	3 × 0.34 mm ²	PP (br, bl, bk)	5 Mio.	PUR (UL/CSA)	4.3 ±5%	10 × outer Ø	-40...+80 °C	-25...+80 °C
034	234	634	4 × 0.34 mm ²	PP (br, wh, bl, bk)	5 Mio.	PUR (UL/CSA)	4.7 ±5%	10 × outer Ø	-40...+80 °C	-25...+80 °C
035	235	635	5 × 0.34 mm ²	PP (br, wh, bl, bk, gnye)	5 Mio.	PUR (UL/CSA)	5.0 ±5%	10 × outer Ø	-40...+80 °C	-25...+80 °C
126	-	732	5 × 0.34 mm ²	PP (br, wh, bl, bk, gr)	5 Mio.	PUR (UL/CSA)	5.0 ±5%	10 × outer Ø	-40...+80 °C	-25...+80 °C
035	235	635	5 × 0.34 mm ²	PP (br, wh, bl, bk, gnye)	5 Mio.	PUR (UL/CSA)	5.0 ±5%	10 × outer Ø	-40...+80 °C	-25...+80 °C
036	236	636	3 × 0.75 mm ²	PP (bk num, gnye)	5 Mio.	PUR (UL/CSA)	5.9 ±5%	10 × outer Ø	-40...+80 °C	-25...+80 °C
037	237	637	4 × 0.75 mm ²	PP (bk num, gnye)	5 Mio.	PUR (UL/CSA)	6.5 ±5%	10 × outer Ø	-40...+80 °C	-25...+80 °C
038	238	638	5 × 0.75 mm ²	PP (bk num, gnye)	5 Mio.	PUR (UL/CSA)	7.0 ±5%	10 × outer Ø	-40...+80 °C	-25...+80 °C
050	250	650	3 × 0.25 mm ²	PP (br, bl, bk)	10 Mio.	PUR (UL/CSA),welding spark	4.3 ±5%	10 × outer Ø	-40...+80 °C	-25...+80 °C
051	251	651	4 × 0.25 mm ²	PP (br, wh, bl, bk)	10 Mio.	PUR (UL/CSA),welding spark	4.7 ±5%	10 × outer Ø	-40...+80 °C	-25...+80 °C
053	253	653	3 × 0.34 mm ²	PP (br, bl, bk)	10 Mio.	PUR (UL/CSA),welding spark	4.3 ±5%	10 × outer Ø	-40...+80 °C	-25...+80 °C
054	254	654	4 × 0.34 mm ²	PP (br, wh, bl, bk)	10 Mio.	PUR (UL/CSA),welding spark	4.7 ±5%	10 × outer Ø	-40...+80 °C	-25...+80 °C
055	255	655	5 × 0.34 mm ²	PP (br, wh, bl, bk, gnye)	10 Mio.	PUR (UL/CSA),welding spark	5.0 ±5%	10 × outer Ø	-40...+80 °C	-25...+80 °C
055	255	655	5 × 0.34 mm ²	PP (br, wh, bl, bk, gnye)	10 Mio.	PUR (UL/CSA),welding spark	5.0 ±5%	10 × outer Ø	-40...+80 °C	-25...+80 °C
056	256	656	3 × 0.75 mm ²	PP (bk num, gnye)	10 Mio.	PUR (UL/CSA),welding spark	5.2 ±5%	10 × outer Ø	-40...+80 °C	-25...+80 °C
114	292	722	8 × 0.25 mm ²	PP (wh, br, gn, ye, gr, pk, bl, rd)	5 Mio.	PUR (UL/CSA)	6.0 ±5%	10 × outer Ø	-40...+80 °C	-25...+80 °C

CABLES

Cables								
green	No./diameter of wires	Wire isolation	C-track properties	Material (jacket)	Outer Ø	Bend radius (moving)	Temperature range (fixed)	Temperature range (mobile)
659 shielded	2x2x0.34 mm ²	PE (wh, ye, bl, or)	2 Mio.	PUR (UL/CSA)	7.4 ±5%	12 × outer Ø	-40...+80 °C	-30...+70 °C
794 shielded	2x2x0.34 mm ²	PE (wh, ye, bl, or)		PUR (UL/CSA)	6.5 ±5%	12 × outer Ø	-40...+80 °C	-20...+60 °C

green	black	red	No./diameter of wires	Wire isolation	C-track properties	Material (jacket)	Outer Ø	Bend radius (moving)	Temperature range (fixed)	Temperature range (mobile)
478	380	578	4x2x0.14 mm ²	PE (bkor, or, bkgn, gn, bkbl, bl, bkbr, br)		FRNC	5.9 ±5%	3 × outer-Ø	0...+50 °C	-20...+60 °C
796 shielded	851 shielded	792 shielded	2x2x0.34 mm ²	PO (wh, ye, bl, or)	3 Mio.	PUR (UL/CSA)	6.7 ±5%	12 × outer Ø	-40...+80 °C	-30...+70 °C

gray	black	No./diameter of wires	Wire isolation	C-track properties	Material (jacket)	Outer Ø	Bend radius (moving)	Temperature range (fixed)	Temperature range (mobile)
200 shielded	600 shielded	3 × 0.34 mm ²	PVC (br, bl, bk)		PVC (UL/CSA)	5.0 ±5%		-30...+80 °C	-5...+80 °C
201 shielded	601 shielded	4 × 0.34 mm ²	PVC (br, wh, bl, bk)		PVC (UL/CSA)	5.3 ±5%		-30...+80 °C	-5...+80 °C
202 shielded	602 shielded	5 × 0.34 mm ²	PVC (br, wh, bl, bk, gnye)		PVC (UL/CSA)	5.6 ±5%		-30...+80 °C	-5...+80 °C
203 shielded	603 shielded	5 × 0.34 mm ²	PVC (br, wh, bl, bk, gr)		PVC (UL/CSA)	5.6 ±5%		-30...+80 °C	-5...+80 °C
204 shielded	604 shielded	8 × 0.25 mm ²	PVC (bl, wh, gn, ye, gr, pk, rd, br)		PVC (UL/CSA)	7.0 ±5%		-30...+80 °C	-5...+80 °C
205 shielded	605 shielded	8 × 0.25 mm ²	PVC (br, wh, bl, bk, gr, pk, vi, or)		PVC (UL/CSA)	7.0 ±5%		-30...+80 °C	-5...+80 °C
206 shielded	706 shielded	12 × 0.14 mm ²	PP (br, bl, wh, gn, pk, ye, bk, gr, rd, vi, grpk, rdbl)	5 Mio.	PUR (UL/CSA)	6.5 ±5%	10 × outer Ø	-40...+80 °C	-25...+80 °C
207	607	8 × 0.25 mm ²	PVC (bl, wh, gn, ye, gr, pk, rd, br)		PVC (UL/CSA)	6.0 ±5%	10 × outer Ø	-30...+80 °C	-5...+80 °C
208	608	8 × 0.25 mm ²	PVC (br, wh, bl, bk, gr, pk, vi, or)		PVC (UL/CSA)	6.0 ±5%	10 × outer Ø	-30...+80 °C	-5...+80 °C
209	609	12 × 0.14 mm ²	PVC (br, bl, wh, gn, pk, ye, bk, gr, rd, vi, grpk, rdbl)		PVC (UL/CSA)	6.0 ±5%	10 × outer Ø	-30...+80 °C	-5...+80 °C
240 shielded	640 shielded	3 × 0.34 mm ²	PP (br, bl, bk)	5 Mio.	PUR (UL/CSA)	5.0 ±5%	10 × outer Ø	-40...+80 °C	-25...+80 °C
241 shielded	641 shielded	4 × 0.34 mm ²	PP (br, wh, bl, bk)	5 Mio.	PUR (UL/CSA)	5.3 ±5%	10 × outer Ø	-40...+80 °C	-25...+80 °C
242 shielded	642 shielded	5 × 0.34 mm ²	PP (br, wh, bl, bk, gnye)	5 Mio.	PUR (UL/CSA)	5.6 ±5%	10 × outer Ø	-40...+80 °C	-25...+80 °C
243 shielded	643 shielded	5 × 0.34 mm ²	PP (br, wh, bl, bk, gr)	5 Mio.	PUR (UL/CSA)	5.6 ±5%	10 × outer Ø	-40...+80 °C	-25...+80 °C
291 shielded	717 shielded	8 × 0.25 mm ²	PP (wh, br, gn, ye, gr, pk, bl, rd)	5 Mio.	PUR (UL/CSA)	7.0 ±5%	10 × outer Ø	-40...+80 °C	-25...+80 °C
294 shielded	715 shielded	8 × 0.25 mm ²	PP (br, wh, bl, bk, gr, pk, vi, or)	5 Mio.	PUR (UL/CSA)	7.0 ±5%	10 × outer Ø	-40...+80 °C	-25...+80 °C

Cables									
black	violet	No./diameter of wires	Wire isolation	C-track properties	Material (jacket)	Outer Ø	Bend radius (moving)	Temperature range (fixed)	Temperature range (mobile)
838 shielded	803 shielded	2×0.25 + 2×0.34 mm ²	PE (rd, bk), (bl, wh)		PUR (UL/CSA)	6.9 ±5%	10 × outer Ø	-40...+80 °C	-30...+70 °C

black	green	No./diameter of wires	Wire isolation	C-track properties	Material (jacket)	Outer Ø	Bend radius (moving)	Temperature range (fixed)	Temperature range (mobile)
805	831	4×0.5 + 1×4×0.14 mm ²	PUR (bl, wh, br, bk, (whor, or)) + (whgn, gn)	5 Mio.	PUR (UL/CSA)	8.1 ±5%	10 × outer Ø	-50...+80 °C	-40...+80 °C

black	yellow	No./diameter of wires	Wire isolation	C-track properties	Material (jacket)	Outer Ø	Bend radius (moving)	Temperature range (fixed)	Temperature range (mobile)
754	145	2 × 0.75 mm ²	PP (br, bl)	5 Mio.	PUR (UL/CSA)	5.0 ±5%	10 × outer Ø	-40...+80 °C	-25...+80 °C

multi-colored	No./diameter of wires	Wire isolation	C-track properties	Material (jacket)	Outer Ø	Bend radius (moving)	Temperature range (fixed)	Temperature range (mobile)
901	4 × 0.34 mm ²	PVC (br, wh, bl, bk)			1.3 ±5%		-40...+105 °C	-5...+105 °C
902	5 × 0.34 mm ²	PVC (br, wh, bl, bk, gr)			1.4 ±5%		-40...+105 °C	-5...+105 °C
903	8 × 0.25 mm ²	PVC (bl, wh, gn, ye, gr, pk, rd, br)			1.15 ±5%		-40...+105 °C	-5...+105 °C
910	3 × 0.25 mm ²	PVC (br, bl, bk)			1.15 ±5%		-40...+105 °C	-5...+105 °C
911	4 × 0.25 mm ²	PVC (br, wh, bl, bk)			2.0 ±5%		-40...+105 °C	-5...+105 °C
940	4 × 1.5 mm ²	PPE (bk num, gnye)					-40...+85 °C	
941	4 × 1.5 mm ²	PVC (br, wh, bl, bk)					-40...+85 °C	
969	4 × 0.25 mm ²	PP (br, bk, bl, wh)			1.1 ±5%		-40...+90 °C	-25...+90 °C
970	3 × 0.25 mm ²	PP (br, bk, bl)			1.1 ±5%		-40...+90 °C	-25...+90 °C
971	4 × 0.34 mm ²	PP (br, wh, bl, bk)			1.3 ±5%		-40...+90 °C	-25...+90 °C
973	8 × 0.25 mm ²	PUR (wh, br, gn, ye, gr, pk, bl, rd)			1.25 ±5%		-40...+90 °C	-25...+90 °C
975	5 × 0.34 mm ²	PUR (br, wh, bl, bk, gnye)			1.3 ±5%		-40...+90 °C	-25...+90 °C
972	5 × 0.34 mm ²	PUR (br, wh, bl, bk, gr)			1.3 ±5%		-40...+90 °C	-25...+90 °C
978	5 × 0.75 mm ²	PVC (br, wh, bl, bk, gnye)			3.1 ±5%		-25...+85 °C	-10...+50 °C
980	5 × 1.5 mm ²	PUR (br, wh, bl, bk, gr)			2.4 ±5%		-40...+90 °C	-25...+90 °C
P80	6 × 2.5 mm ²	PVC (bk, bl, num, gnye)			3.7 ±5%		-40...+70 °C	
P81	4 × 1.5 mm ²	PVC (bk num, gnye)			3.1 ±5%		-40...+70 °C	
P82	4 × 2.5 mm ²	PVC (bk num, gnye)			3.7 ±5%		-40...+70 °C	

gray	No./diameter of wires	Wire isolation	C-track properties	Material (jacket)	Outer Ø	Bend radius (moving)	Temperature range (fixed)	Temperature range (mobile)
202 shielded	5 × 0.34 mm ²	PVC (br, wh, bl, bk, gnye)		PVC (UL/CSA)	5.6 ±5%		-30...+80 °C	-5...+80 °C
203 shielded	5 × 0.34 mm ²	PVC (br, wh, bl, bk, gr)		PVC (UL/CSA)	5.6 ±5%		-30...+80 °C	-5...+80 °C
215	5 × 0.34 mm ²	PVC (br, wh, bl, bk, gnye)		PVC (UL/CSA)	5.2 ±5%	10 × outer Ø	-30...+80 °C	-5...+80 °C
295	8 × 0.25 mm ²	PP (br, wh, bl, bk, gr, pk, vi, or)	5 Mio.	PUR (UL/CSA)	6.0 ±5%	10 × outer Ø	-40...+80 °C	-25...+80 °C

CABLES

Cables								
gray	No./diameter of wires	Wire isolation	C-track properties	Material (jacket)	Outer Ø	Bend radius (moving)	Temperature range (fixed)	Temperature range (mobile)
301	12 × 0.25 mm ²	PP (br, bl, wh, gn, pk, ye, bk, gr, rd, vi, grpk, rdbl)	3 Mio.	PUR (UL/CSA)	6.9 ±5%	15 × outer Ø	-40...+80 °C	-20...+80 °C
302	12 × 0.25 mm ²	PP (br, bl, wh, gn, pk, ye, bk, gr, rd, vi, grpk, rdbl)	5 Mio.	PUR (UL/CSA),welding spark	6.9 ±5%	10 × outer Ø	-40...+80 °C	-25...+80 °C
336	4 × 0.34 mm ²	TPE-S (br, wh, bl, bk)		TPE-S	5.2 ±5%	15 × outer Ø	-50...+125 °C	-30...+105 °C
414	2 × 0.5 mm ²	PP (br, bl)	5 Mio.	PUR (UL/CSA)	4.4 ±5%	10 × outer Ø	-40...+80 °C	-25...+80 °C
588	2 × 1.5 mm ²	PP (br, bl)	5 Mio.	PUR (UL/CSA)	8.0 ±5%	15 × outer Ø	-50...+80 °C	-25...+80 °C
777	2×2×AWG26	FRNC (wh, bl, wh, or)		FRNC	5.0 ±5%	10 × outer Ø	0...+50 °C	-20...+60 °C
862	4 × 0.75 mm ²	PP (br, wh, bl, bk)	5 Mio.	PUR (UL/CSA)	6.5 ±5%	10 × outer Ø	-40...+80 °C	-25...+80 °C
961	5 × 1.5 mm ²	PP (br, wh, bl, bk, gnye)	5 Mio.	PUR (UL/CSA)	8.7 ±5%	10 × outer Ø	-50...+80 °C	-20...+80 °C
962	5 × 2.5 mm ²	PP (br, wh, bl, bk num, gnye)	5 Mio.	PUR (UL/CSA)	9.7 ±5%	10 × outer Ø	-50...+80 °C	-20...+80 °C
965	5 × 1.0 mm ²	PP (br, wh, bl, bk num, gnye)		PUR/PVC	7.2 ±5%	10 × outer Ø	-30...+70 °C	-5...+70 °C
966	5 × 1.5 mm ²	PP (br, wh, bl, bk, gr)		PUR/PVC	8.7 ±5%	10 × outer Ø	-30...+70 °C	-5...+70 °C

yellow	No./diameter of wires	Wire isolation	C-track properties	Material (jacket)	Outer Ø	Bend radius (moving)	Temperature range (fixed)	Temperature range (mobile)
150	4 × 0.75 mm ²	PVC (br, wh, bl, bk)	10 Mio.	TPE (UL/CSA)	7.2 ±5%	15 × outer Ø	-40...+105 °C	-20...+90 °C
161	5 × 0.75 mm ²	PVC (br, wh, bl, bk, gnye)	10 Mio.	TPE (UL/CSA)	7.7 ±5%	15 × outer Ø	-40...+105 °C	-20...+90 °C
162	5 × 0.75 mm ²	PVC (br, wh, bl, bk, gr)	10 Mio.	TPE (UL/CSA)	7.7 ±5%	15 × outer Ø	-40...+105 °C	-20...+90 °C
U1B	3 × 1.5 mm ²	PVC (bk, gn, wh)		TPE (UL/CSA)	8.4 ±5%	10 × outer Ø	-50...+105 °C	-20...+90 °C
U1C	4 × 1.5 mm ²	PVC (bk, gn, rd, wh)		TPE (UL/CSA)	9.0 ±5%	10 × outer Ø	-50...+105 °C	-20...+90 °C
U1D	5 × 1.5 mm ²	PVC (bk, or, gn, rd, wh)		TPE (UL/CSA)	9.8 ±5%	10 × outer Ø	-50...+105 °C	-20...+90 °C

green	No./diameter of wires	Wire isolation	C-track properties	Material (jacket)	Outer Ø	Bend radius (moving)	Temperature range (fixed)	Temperature range (mobile)
659 shielded	2×2×0.34 mm ²	PE (wh, ye, bl, or)	2 Mio.	PUR (UL/CSA)	7.4 ±5%	12 × outer Ø	-40...+80 °C	-30...+70 °C
790 shielded	4×2×0.14 mm ²	PE (whbl, bl, whor, or, whgn, gn, whbr, br)		PUR (UL/CSA)	6.4 ±5%	12 × outer Ø	-30...+80 °C	-10...+50 °C
791 shielded	1×4×0.15 mm ²	PO (wh, ye, bl, or)	5 Mio.	PUR (UL/CSA)	4.9 ±5%	12 × outer Ø	-20...+80 °C	-20...+50 °C
793 shielded	1×4×0.34 mm ²	PE (wh, ye, bl, or)		PUR (UL/CSA)	6.6 ±5%	12 × outer Ø	-40...+80 °C	-20...+60 °C
794 shielded	2×2×0.34 mm ²	PE (wh, ye, bl, or)		PUR (UL/CSA)	6.5 ±5%	12 × outer Ø	-40...+80 °C	-20...+60 °C
800 shielded	2×2×0.34 mm ²	PE (wh, ye, bl, or)	2 Mio.	PVC (UL/CSA)	6.5 ±5%	15 × outer Ø	-30...+80 °C	-10...+70 °C
802 shielded	4×0.5 + 2×0.25 mm ²	TPE (bl, wh, br, bk), (gr, pk)	5 Mio.	PUR (UL/CSA)	7.9 ±5%	10 × outer Ø	-50...+80 °C	-40...+80 °C
57V shielded	2×2×0.34 mm ²	HDPE (wh, ye, bl, or)	1 Mio.	TPE (UL)	7.9 ±5%	10 × outer Ø	-40...+80 °C	-20...+80 °C

Cables								
violet	No./diameter of wires	Wire isolation	C-track properties	Material (jacket)	Outer Ø	Bend radius (moving)	Temperature range (fixed)	Temperature range (mobile)
840 shielded	1×2×0.25 mm ²	PE (rd, gn)	5 Mio.	PUR (UL/CSA)	7.8 ±5%	12 × outer Ø	-40...+80 °C	-20...+60 °C
841 shielded	1×2×0.25 mm ²	PE (rd, gn)	5 Mio.	PUR (UL/CSA)	7.7 ±5%	12 × outer Ø	-40...+80 °C	-20...+60 °C
843 shielded	1×2×0.25 mm ²	PE (rd, gn)		PUR (UL/CSA)	8.0 ±5%	12 × outer Ø	-40...+80 °C	-20...+50 °C
850 shielded	1×2×0.25 mm ²	PE (rd, gn)	2 Mio.	PVC (UL)	7.8 ±5%	12 × outer Ø	-25...+70 °C	-20...+60 °C

black	No./diameter of wires	Wire isolation	C-track properties	Material (jacket)	Outer Ø	Bend radius (moving)	Temperature range (fixed)	Temperature range (mobile)
512	2 × 0.75 mm ²	PP (br, bl)	4 Mio.	PUR (UL)	5.0 ±5%	10 × outer Ø	-40...+80 °C	-25...+80 °C
513	3 × 0.75 mm ²	PP (br, bl, bk)	4 Mio.	PUR (UL)	5.3 ±5%	10 × outer Ø	-40...+80 °C	-25...+80 °C
514	4 × 0.75 mm ²	PP (br, wh, bl, bk)	2 Mio.	PUR (UL)	5.7 ±5%	6 × outer Ø		-25...+80 °C
516	6 × 0.75 mm ²	PP (br, gn, ye, gr, pk, wh)	4 Mio.	PUR (UL)	6.9 ±5%	12 × outer Ø	-40...+80 °C	-25...+80 °C
564	3 × 0.75 mm ²	PP (br, bl, bk)	5 Mio.	PUR (UL/CSA)	5.9 ±5%	10 × outer Ø	-40...+80 °C	-25...+80 °C
569	4 × 0.75 mm ²	PP (br, wh, bl, bk)	5 Mio.	PUR (UL/CSA)	6.5 ±5%	10 × outer Ø	-40...+80 °C	-25...+80 °C
572	6 × 0.75 mm ²	PP (br, wh, bl, bk, gr, pk)	5 Mio.	PUR (UL/CSA)	7.3 ±5%	10 × outer Ø	-40...+80 °C	-25...+80 °C
634	4 × 0.34 mm ²	PP (br, wh, bl, bk)	5 Mio.	PUR (UL/CSA)	4.7 ±5%	10 × outer Ø	-40...+80 °C	-25...+80 °C
703 shielded	12 × 0.14 mm ²	PVC (br, bl, wh, gn, pk, ye, bk, gr, rd, vi, grp, rdbl)		PVC (UL/CSA)	6.5 ±5%	10 × outer Ø	-30...+80 °C	-5...+80 °C
705	12 × 0.14 mm ²	PP (br, bl, wh, gn, pk, ye, bk, gr, rd, vi, grp, rdbl)	2 Mio.	PUR (UL/CSA)	6.0 ±5%	10 × outer Ø	-40...+85 °C	-25...+85 °C
740	2 × 0.5 mm ²	TPE (bk, wh)	2 Mio.	PUR	5.0 ±5%	10 × outer Ø	-50...+90 °C	-30...+90 °C
750	2 × 0.75 mm ²	PVC (br, bl)		PUR/PVC	5.9 ±5%	15 × outer Ø	-40...+80 °C	-5...+80 °C
P01	6 × 2.5 mm ²	TPM (bk num, gnye)	5 Mio.	PUR (UL)	11.1 ±5%	10 × outer Ø	-40...+80 °C	-20...+60 °C
P02	4 × 1.5 mm ²	TPM (bk num, gnye)	5 Mio.	PUR (UL)	7.4 ±5%	10 × outer Ø	-50...+80 °C	-20...+70 °C
P03	4 × 2.5 mm ²	TPM (bk num, gnye)	5 Mio.	PUR (UL)	9.0 ±5%	10 × outer Ø	-50...+80 °C	-20...+70 °C
P04	5 × 1.5 mm ²	PP (br, wh, bl, bk, gr, num)	5 Mio.	PUR (UL/CSA)	8.7 ±5%	10 × outer Ø	-50...+80 °C	-20...+80 °C
P05	5 × 1.5 mm ²	PP (br, wh, bl, bk num, gnye)	5 Mio.	PUR (UL/CSA)	8.7 ±5%	10 × outer Ø	-50...+80 °C	-20...+80 °C
P06	4 × 1.5 mm ²	PP (br, wh, bl, num; gnye longitudinally striped)	5 Mio.	PUR (UL/CSA)	7.7 ±5%	10 × outer Ø	-50...+80 °C	-20...+80 °C
P07	4 × 1.5 mm ²	PP (br, wh, bl, bk, num)	5 Mio.	PUR (UL/CSA)	7.7 ±5%	10 × outer Ø	-50...+80 °C	-20...+80 °C
P21	6 × 2.5 mm ²	PP (bk num, gnye)		PVC (UL)	11.0 ±5%	15 × outer Ø	-20...+80 °C	-5...+80 °C
P22	4 × 1.5 mm ²	PP (bk num, gnye)		PVC (UL)	7.4 ±5%	15 × outer Ø	-20...+80 °C	-5...+80 °C
P23	4 × 2.5 mm ²	PP (bk num, gnye)		PVC (UL)	9.1 ±5%	15 × outer Ø	-20...+80 °C	-5...+80 °C
P24	6 × 1.5 mm ²	PP (bk num, gnye)		PVC (UL)	9.0 ±5%	15 × outer Ø	-20...+80 °C	-5...+80 °C
P84	6 × 1.5 mm ²	TPM (bk num, gnye)	5 Mio.	PUR (UL)	9.0 ±5%	6.8 × outer-Ø	-50...+80 °C	-20...+70 °C
UMB	3 × 1.5 mm ²	TPM (br, bl, gnye)	5 Mio.	PUR (UL/CSA)	7.4 ±5%	10 × outer Ø	-40...+80 °C	-20...+80 °C
UMC	4 × 1.5 mm ²	TPM (br, wh, bl, bk)	5 Mio.	PUR (UL/CSA)	8.0 ±5%	10 × outer Ø	-50...+80 °C	-20...+80 °C
UMD	5 × 1.5 mm ²	TPM (br, wh, bl, bk, gnye)	5 Mio.	PUR (UL/CSA)	8.7 ±5%	10 × outer Ø	-50...+80 °C	-20...+80 °C

CABLES

Cables								
orange	No./diameter of wires	Wire isolation	C-track properties	Material (jacket)	Outer Ø	Bend radius (moving)	Temperature range (fixed)	Temperature range (mobile)
P11 shielded	4×2.5 + 2×1.5 mm ²	TPM (bk num, gnye)	5 Mio.	PUR (UL)	12.8 ±5%	10 × outer Ø	-25...+80 °C	-20...+80 °C
P12 shielded	4 × 1.5 mm ²	TPM (bk num, gnye)	5 Mio.	PUR (UL)	8.0 ±5%	10 × outer Ø	-40...+80 °C	-20...+60 °C
P13 shielded	4 × 2.5 mm ²	TPM (bk num, gnye)	5 Mio.	PUR (UL)	10.6 ±5%	7.5 × outer Ø	-50...+80 °C	-35...+70 °C
pastel blue	No./diameter of wires	Wire isolation	C-track properties	Material (jacket)	Outer Ø	Bend radius (moving)	Temperature range (fixed)	Temperature range (mobile)
315	3 × 0.34 mm ²	PP (br, bl, bk)	4 Mio.	TPE-S (UL)	4.3 ±5%	10 × outer Ø	-40...+105 °C	-25...+105 °C
321	4 × 0.34 mm ²	PP (br, wh, bl, bk)	4 Mio.	TPE-S	4.7 ±5%	10 × outer Ø	-40...+105 °C	-25...+105 °C
339	5 × 0.34 mm ²	PP (br, wh, bl, bk, gnye)	4 Mio.	TPE (UL)	5.0 ±5%	10 × outer Ø	-40...+105 °C	-25...+105 °C
blue	No./diameter of wires	Wire isolation	C-track properties	Material (jacket)	Outer Ø	Bend radius (moving)	Temperature range (fixed)	Temperature range (mobile)
S4U shielded	2×2×0.25 mm ²	HDPE (whor, or, whgn, gn)	1 Mio.	TPE (UL/CSA)	6.6 ±5%	10 × outer Ø	-40...+80 °C	-20...+80 °C
S4W shielded	4×2×0.25 mm ²	HDPE (whbl, bl, whor, or, whgn, gn, whbr, br)	1 Mio.	TPE (UL/CSA)	7.6 ±5%	10 × outer Ø	-40...+80 °C	-20...+80 °C
S4X shielded	4×2×0.14 mm ²	HDPE (whbl, bl, whor, or, whgn, gn, whbr, br)	1 Mio.	TPE (UL/CSA)	7.4 ±5%	10 × outer Ø	-40...+80 °C	-20...+80 °C
gray	No./diameter of wires	C-track properties	Material (jacket)	Outer Ø	Bend radius (moving)	Temperature range (fixed)	Temperature range (mobile)	
333	4×0.34 + 3×0.75 mm ²	2 Mio.	PUR/PVC	7.4 ±5%	12 × outer Ø	-30...+80 °C	-5...+80 °C	
334	4×0.34 + 2×0.75 mm ²	5 Mio.	PUR (UL/CSA)	7.6 ±5%	10 × outer Ø	-40...+80 °C	-5...+60 °C	
337	4×0.34 + 2×0.75 mm ²	2 Mio.	PUR/PVC	6.9 ±5%	10 × outer Ø	-30...+80 °C	-5...+60 °C	
350	6×0.34 + 2×0.75 mm ²	2 Mio.	PUR/PVC	7.8 ±5%	10 × outer Ø	-30...+80 °C	-5...+60 °C	
356	6×0.34 + 2×0.75 mm ²	5 Mio.	PUR (UL/CSA)	8.5 ±5%	10 × outer Ø	-40...+80 °C	-5...+60 °C	
357	8×0.34 + 2×0.75 mm ²	2 Mio.	PUR/PVC	8.6 ±5%	10 × outer Ø	-30...+80 °C	-5...+60 °C	
358	8×0.34 + 2×0.75 mm ²	1.5 Mio.	PUR/PVC	8.6 ±5%	12 × outer Ø	-30...+70 °C	-5...+60 °C	
359	8×0.34 + 2×0.75 mm ²	5 Mio.	PUR (UL/CSA)	9.2 ±5%	10 × outer Ø	-40...+80 °C	-5...+60 °C	
360	8×0.34 + 2×0.75 mm ²	5 Mio.	PUR (UL/CSA)	9.2 ±5%	10 × outer Ø	-40...+80 °C	-5...+60 °C	
362	8×0.34 + 3×0.75 mm ²	2 Mio.	PUR/PVC (UL/CSA)	8.1 ±5%	10 × outer Ø	-30...+80 °C	-5...+70 °C	
363	8×0.34 + 3×0.75 mm ²	2 Mio.	PUR/PVC (UL/CSA)	8.1 ±5%	10 × outer Ø	-30...+80 °C	-5...+70 °C	
373 shielded	8×0.34 + 3×0.75 mm ²	5 Mio.	PUR (UL/CSA)	9.3 ±5%	12 × outer Ø	-40...+90 °C	-40...+90 °C	
374	8×0.34 + 5×0.75 mm ²	1.5 Mio.	PUR/PVC	9.2 ±5%	12 × outer Ø	-30...+80 °C	-30...+80 °C	
384	10×0.34 + 2×0.75 mm ²	5 Mio.	PUR (UL/CSA)	9.3 ±5%	10 × outer Ø	-40...+80 °C	-5...+60 °C	
385	10×0.34 + 2×0.75 mm ²	2 Mio.	PUR/PVC	8.3 ±5%	10 × outer Ø	-30...+80 °C	-5...+60 °C	
386	12×0.34 + 2×0.75 mm ²	1.5 Mio.	PUR/PVC	8.8 ±5%	12 × outer Ø	-30...+70 °C	-5...+60 °C	
389	12×0.34 + 2×0.75 mm ²	5 Mio.	PUR (UL/CSA)	9.5 ±5%	10 × outer Ø	-40...+80 °C	-5...+60 °C	
395	16×0.34 + 2×0.75 mm ²	1.5 Mio.	PUR/PVC	9.6 ±5%	12 × outer Ø	-30...+70 °C	-5...+60 °C	
396	16×0.34 + 2×0.75 mm ²	5 Mio.	PUR (UL/CSA)	10.4 ±5%	10 × outer Ø	-40...+80 °C	-5...+60 °C	
398	16×0.34 + 3×0.75 mm ²	2 Mio.	PUR/PVC (UL/CSA)	10.0 ±5%	10 × outer Ø	-30...+80 °C	-5...+70 °C	
401 shielded	16×0.34 + 3×0.75 mm ²	5 Mio.	PUR (UL/CSA)	11.7 ±5%	12 × outer Ø	-40...+90 °C	-40...+90 °C	
403	16×0.34 + 5×0.75 mm ²	5 Mio.	PUR (UL/CSA)	11.5 ±5%	10 × outer Ø	-40...+90 °C	-40...+90 °C	
404	16×0.34 + 5×0.75 mm ²	1.5 Mio.	PUR/PVC	12.5 ±5%	12 × outer Ø	-30...+80 °C	-30...+80 °C	
407	20×0.34 + 3×0.75 mm ²	2 Mio.	PUR/PVC (UL/CSA)	10.0 ±5%	12 × outer Ø	-30...+80 °C	-5...+60 °C	
408	20×0.34 + 3×0.75 mm ²	5 Mio.	PUR (UL/CSA)	10.4 ±5%	10 × outer Ø	-40...+80 °C	-5...+80 °C	
411	20×0.34 + 2×0.75 mm ²	5 Mio.	PUR (UL/CSA)	11.3 ±5%	10 × outer Ø	-40...+80 °C	-5...+60 °C	
412	20×0.34 + 2×0.75 mm ²	1.5 Mio.	PUR/PVC	10.4 ±5%	12 × outer Ø	-30...+70 °C	-5...+60 °C	
447	8×0.5 + 3×1.0 mm ²	5 Mio.	PUR (UL/CSA)	9.4 ±5%	10 × outer Ø	-40...+80 °C	-5...+80 °C	
448	8×0.5 + 3×1.0 mm ²	5 Mio.	PUR (UL/CSA)	9.1 ±5%	10 × outer Ø	-40...+90 °C	-40...+90 °C	
452	16×0.5 + 3×1.0 mm ²	5 Mio.	PUR (UL/CSA)	11.5 ±5%	10 × outer Ø	-40...+80 °C	-5...+80 °C	



4

I/O SYSTEMS

4

I/O SYSTEMS

Cube67	4.1
Cube20	4.2
Cube20S	4.3
MVK Metal	4.4
SOLID67	4.5
Impact67	4.6
IO-Link Devices	4.7
MASI Control Cabinet	4.8
MASI Field Installation	4.9
MASI Installation Technology	4.10
M8 Distribution Systems	4.11
M12 Distribution Systems (Metal)	4.12
M12 Distribution Systems (Plastic)	4.13



CUBE67 MODULAR I/O STATION IP67

- Distributed
- Flexible
- Open system

THE COMPACT MODULAR I/O SYSTEM

Cube is a modular field bus system for perfect distributed installation concepts. Its flexibility facilitates developing the perfect solution for any application – with consistent degrees of protection from IP20 to IP69K.

Cube's characteristics are: great functionality, plug-in connections, a robust and compact design, encapsulated modules, and multi-functional inputs and outputs. The modules are installed next to the sensors and actuators.

Cube67 I/O modules

 <p>Bus nodes</p> <ul style="list-style-type: none"> • PROFIBUS DP • PROFINET IO • EtherNet/IP • EtherCAT <p style="text-align: right;"><i>Page 4.1.1</i></p>	 <p>Diagnostic gateway</p> <ul style="list-style-type: none"> • Diagnostics made easy • Ethernet TCP/IP <p style="text-align: right;"><i>Page 4.1.3</i></p>
 <p>Digital inputs</p> <ul style="list-style-type: none"> • NPN • VPN <p style="text-align: right;"><i>Page 4.1.4</i></p>	 <p>Digital inputs/outputs</p> <ul style="list-style-type: none"> • Multifunctional <p style="text-align: right;"><i>Page 4.1.7</i></p>
 <p>Function modules</p> <ul style="list-style-type: none"> • IO-Link • Counter module • Communication module <p style="text-align: right;"><i>Page 4.1.14</i></p>	<p style="text-align: center;"> IO-Link</p>  <p>Analog inputs/outputs</p> <ul style="list-style-type: none"> • Voltage/current • For resistors and temperature • For thermo elements <p style="text-align: right;"><i>Page 4.1.17</i></p>
 <p>Safe outputs</p> <ul style="list-style-type: none"> • Passive <p style="text-align: right;"><i>Page 4.1.20</i></p>	 <p>Function modules hygenic design</p> <ul style="list-style-type: none"> • Multifunctional • IO-Link <p style="text-align: right;"> <i>Page 4.1.21</i></p>
 <p>Cable/Valve</p> <ul style="list-style-type: none"> • Digital outputs • Digital inputs/outputs (multifunctional) • Safe outputs • Valve connections • With open ended wires <p style="text-align: right;"><i>Page 4.1.23</i></p>	 <p style="text-align: right;"><i>Please do not hesitate to contact us. We offer a wide range for Cube67 system cables.</i></p>

HIGHLIGHTS OF THE CUBE SYSTEM

- **Customer-oriented installation concepts**, perfectly customized solutions for any given application
- **Great cost-benefit ratio** through lower planning and installation effort
- **Extreme flexibility** through multi-functional slots and numerous function modules (IO-Link, RS485/ MOVIMOT®...)
- System-independent through **"bus replacement without system replacement"** for all common bus systems worldwide
- **Maximized transparency** through precise and detailed diagnostics options

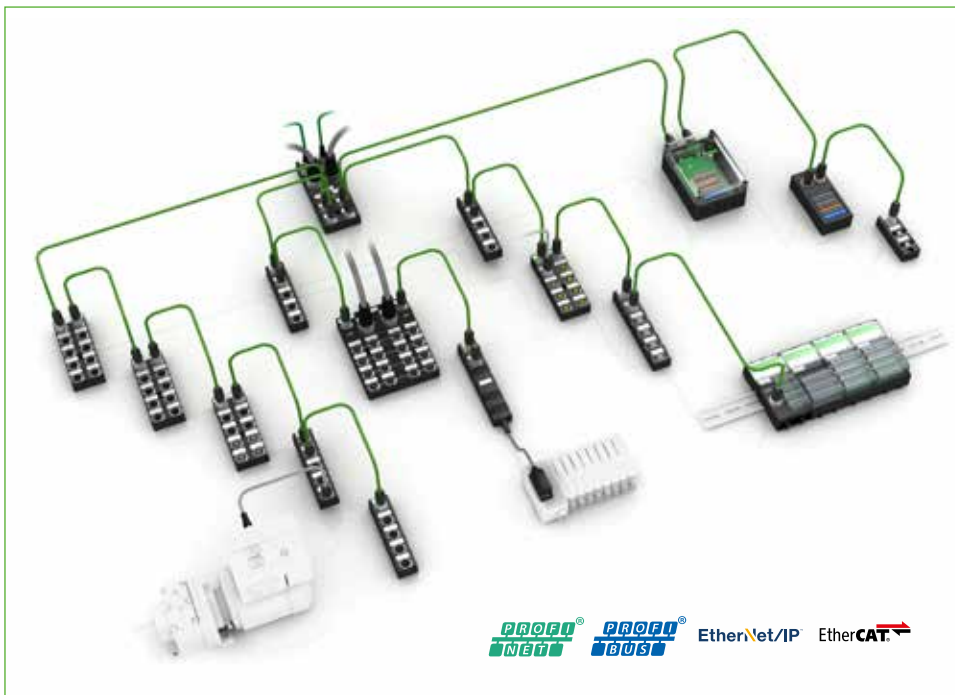

PROFI[®] NET EtherNet/IP EtherCAT[®]
PROFI[®] BUS

CUBE67 DIAGNOSTICS GATEWAY Diagnostics made easy

- **Commissioning engineers** use the diagnostics gateway to examine the topology of the Cube system and to detect installation faults at an early stage.
- The service personnel of the machine or system builder quickly identifies errors by temporarily integrating the diagnostics gateway. Moreover, this system is a perfect solution for machine acceptance tests. Permanent integration is also of great interest in order to be able to guide, for example the electrician, in the field via remote access.
- The **operator of a machine or system** who incorporates the diagnostics gateway permanently is able to react to potential problems at an early stage. In a best-case scenario, instructions for troubleshooting have already been implemented, allowing the installer to bring the required spare part right with him when he comes for repairs.

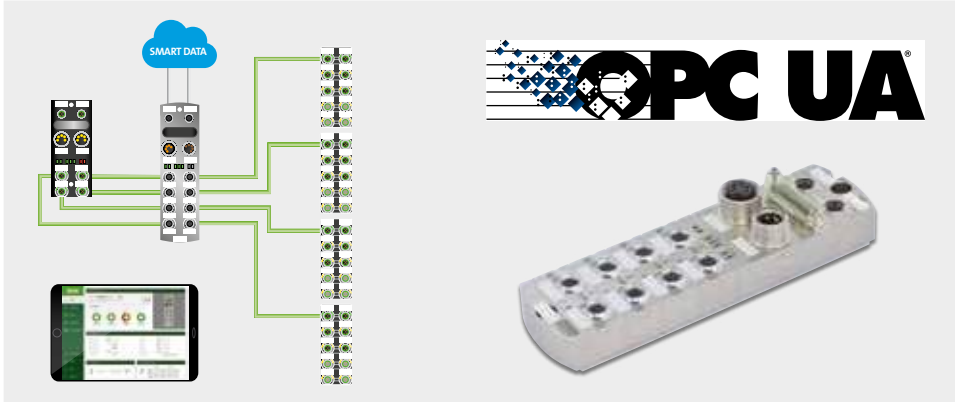

FUNCTIONALITY WITH GREAT UTILIZABLE VALUE

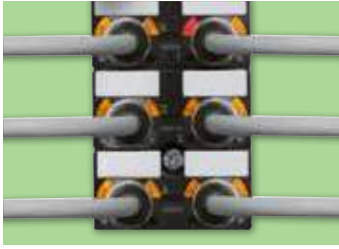

Diagnostics

Detailed diagnostics messages to the controller and LED status indicators at the slots facilitate fast localization of errors. **This reduces commissioning time and downtimes.**



Multi-functional I/Os

Connections can – depending on the requirement at any given location in the distributed installation – be parameterized as inputs, diagnostic inputs or outputs. This allows the connection of various components to a module. **As a result, there is great flexibility and a reduced number of variants.**

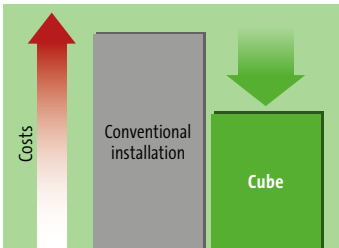

Saves time and money

Maximized economy through reduced effort in design and installation of hardware and software. Increased production capacities and shorter lead times. **This is how Cube secures you a competitive edge.**



Safety

Cube enables passive safety technology solutions. The M12 outputs and connections for the valve terminals can be used in installations up to category 3 and performance level d (according DIN EN ISO 13849). **This facilitates easy integration of safety technology without great wiring effort.**



Cable

Cube67 only needs a single system bus cable for both power supply and data transmission. Prefabricated cables minimize error sources. **The installation requires just half the space and can be completed in half the time.**



IO-Link by Murrelektronik

The integration of up to 128 smart IO-Link devices in Cube67+ opens up additional possibilities in using variable machines. Cube67+ in combination with IO-Link offers this additional functionality for M12 ports. **This enables flexible and automated parameterization of devices.**

CUBE67

Bus nodes, Cube67+

– up to 32 modules



Approvals: UL_{us} Listed

Cube67+ BN-P

PROFIBUS DP



Cube67+ BN-PNIO

PROFINET IO



Order Data	Art-No.	Art-No.
PROFIBUS DP	56521	
PROFINET IO		56526
Connections		
Fieldbus	PROFIBUS 12 Mbit/s; M12, B-coded	Ethernet 10/100Mbit/s; M12, D-coded
Sensor-system/actuator supply	7/8", 5-pole, 2 × max. 8 A	
Internal system connection	4 × M12 (female) A-coded, 6-pole, 2 × max. 4 A	
Module Supply		
Operating voltage	24 V DC (EN 61131-2)	
Current consumption	max. 120 mA	max. 200 mA
PROFIBUS		
Addressing	Rotary switch 0...99	–
PROFINET		
Addressing	–	DCP
Specification	–	V2.2, Conformance Class B
Cube system		
Module capacity	max. 32	
I/O capacity	max. 244 Byte (Input), max. 244 Byte (Output)	max. 1024 Byte (Input), max. 1024 Byte (Output)
Machine Option Management	yes	
No. of masterports (IO-Link)	max. 12	max. 128
Diagnostic		
Communication status	via LED and BUS	
Diagnostic via LED	per module and channel	
Diagnostic via BUS	per module and channel	
Monitoring - under voltage	yes	
Monitoring - no voltage	yes	
Short-circuit and overload	yes	
General data		
Protection	IP67	
Mounting method	2-hole screw mounting	
Temperature range	0...+55 °C (storage temperature -20...+75 °C)	

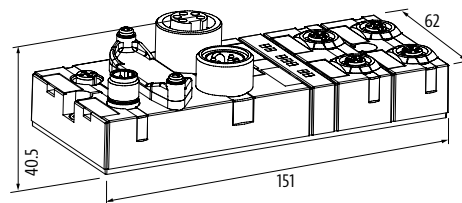

Notes
Cube67+ modules can only be operated on Cube67+, EtherNet/IP, Profibus + ProfiNet bus nodes.

CUBE67

Bus nodes, Cube67+

– up to 32 modules

EtherNet/IP EtherCAT

Approvals:  Listed

Cube67+ BN-E

EtherNet/IP

Cube67+ BN-EC

EtherCAT



Order Data	Art-No.	Art-No.	Art-No.
EtherNet/IP	56535		
EtherCAT		56527	
EtherCAT Rotary Switch			5652701

Connections

Fieldbus	Ethernet 10/100Mbit/s; M12, D-coded		
Sensor-system/actuator supply	7/8", 5-pole, 2 × max. 8 A		
Internal system connection	4 × M12 (female) A-coded, 6-pole, 2 × max. 4 A		

Module Supply

Operating voltage	24 V DC (EN 61131-2)		
Current consumption	max. 200 mA		

EtherNet/IP

Addressing	DHCP, BOOTP or IP address by rotary switch	–	
------------	--	---	--

EtherCAT

Addressing	–	automatic	Rotary switch 0...999
------------	---	-----------	-----------------------

Cube system

Module capacity	max. 32		
I/O capacity	max. 504 Byte (Input), max. 500 Byte (Output)		max. 65 636 Byte (Input), max. 65 636 Byte (Output)
Machine Option Management	yes		
No. of masterports (IO-Link)	max. 128		

Diagnostic

Communication status	via LED and BUS		
Diagnostic via LED	per module and channel		
Diagnostic via BUS	per module and channel		
Monitoring - under voltage	yes		
Monitoring - no voltage	yes		
Short-circuit and overload	yes		

General data

Protection	IP67		
Mounting method	2-hole screw mounting		
Temperature range	0...+55 °C (storage temperature -20...+75 °C)		

Dimension drawing

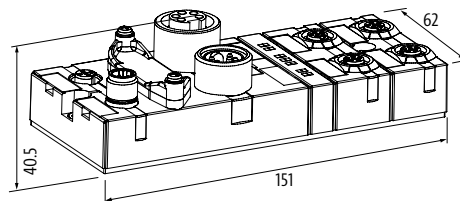

Notes

Cube67+ modules can only be operated on Cube67+, EtherNet/IP, Profibus + ProfiNet bus nodes.

CUBE67

Diagnostic gateway

– Ethernet TCP/IP

Cube67

Diagnostics made easy



Approvals:  UL
Listed

Order Data		Art-No.
Diagnostic Gateway		56968
Connections		
Fieldbus	2 × M12 (female), D-coded	
Internal system connection	8 × M12 (female), 6-pole	
Supply	2 × 7/8" (male/female), 5-pole	
Module Supply		
Operating voltage	24 V DC ±25%	
Current consumption	max. 200 mA	
Cube system		
Cube67 system connection	yes	
Protection		
Reverse polarity protection module	yes	
Over voltage protection	yes	
General data		
Protection	IP67	
Mounting method	2-hole screw mounting	
Temperature range	0...+55 °C (storage temperature -25...+70 °C)	
Dimension drawing		

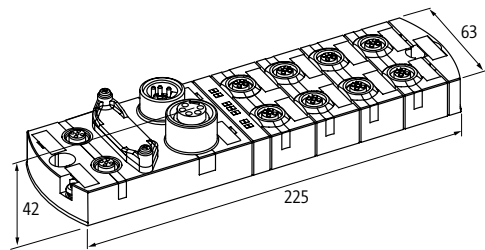

Notes	
	Current manuals can be downloaded at: www.murrelektronik.com

CUBE67

Digital inputs

Cube67 DI16 C - 8×M12

Compact module



Cube67 DI8 C - 4×M12

Compact module



Cube67 DI8 C - 8×M8

Compact module

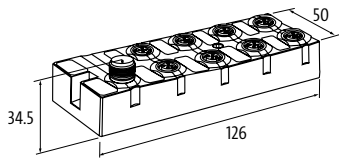
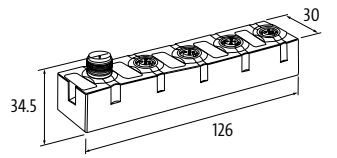
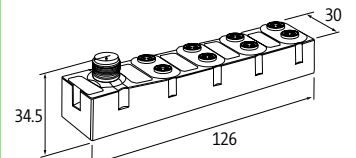

Approvals:  Listed

Order Data	Art-No.	Art-No.	Art-No.
DI16 - (C) 8×M12	56602		
DI8 - (C) 4×M12		56612	
DI8 - (C) 8×M8			56622
Internal communication			
Current consumption	max. 50 mA		max. 30 mA
LED display	US: sensor supply and internal supply voltage (green: OK); UA: actuator supply (green: OK)		
Terminating resistor	integrated into the module		
Connections			
Fieldbus	via internal system connection		
Sensor-system/actuator supply	via internal system connection (max. 2×4 A)		
I/O ports	M12 (female) 5-pole, A-coded		M8 (female) 3-pole, A-coded
Input			
Sensor supply US	24 V DC (EN 61131-2), max. 200 mA (M12 female), short-circuit and overload protected		24 V DC (EN 61131-2), max. 200 mA (M8 female), short-circuit and overload protected
Type	for 3-wire sensors or mechanical switches, PNP		
Input filter	1 ms		
Parameterization			
PIN 2	Input/Diagnostic	-	
PIN 4	Input		
Diagnostic			
Communication status	via LED		
Diagnostic via LED	per module and channel		
Diagnostic via BUS	per module and channel		
Monitoring - under voltage	yes		
Monitoring - no voltage	yes		
Short-circuit and overload	yes		
General data			
Protection	IP67		
Mounting method	2-hole screw mounting		
Temperature range	0...+55 °C (storage temperature -20...+75 °C)		
Dimension drawing			
			
Notes			

CUBE67

Digital inputs

Cube67 DI16 E - 8×M12

Expansion module



Cube67 DI8 E - 4×M12

Expansion module



Cube67 DI8 E - 8×M8

Expansion module



Approvals: UL^{us}
Listed

Order Data	Art-No.	Art-No.	Art-No.
DI16 - (E) PNP (8×M12)	56603		
DI8 - (E) PNP (4×M12)		56613	
DI8 - (E) PNP (8×M8)			56623
Internal communication			
Current consumption	max. 50 mA		max. 30 mA
LED display	US: sensor supply and internal supply voltage (green: OK); UA: actuator supply (green: OK)		
Connections			
Fieldbus	via internal system connection		
Sensor-system/actuator supply	via internal system connection (max. 2×4 A)		
I/O ports	M12 (female) 5-pole, A-coded		M8 (female) 3-pole, A-coded
Input			
Sensor supply US	24 V DC (EN 61131-2), max. 200 mA (M12 female), short-circuit and overload protected		24 V DC (EN 61131-2), max. 200 mA (M8 female), short-circuit and overload protected
Type	for 3-wire sensors or mechanical switches, PNP		
Input filter	1 ms		
Parameterization			
PIN 2	Input/Diagnostic	-	
PIN 4	Input		
Diagnostic			
Communication status	via LED		
Diagnostic via LED	per module and channel		
Diagnostic via BUS	per module and channel		
Monitoring - under voltage	yes		
Monitoring - no voltage	yes		
Short-circuit and overload	yes		
General data			
Protection	IP67		
Mounting method	2-hole screw mounting		
Temperature range	0...+55 °C (storage temperature -20...+75 °C)		
Dimension drawing			
Notes			

CUBE67

Digital inputs

Cube67 DI16 E - 8×M12

Expansion module
Form NPN



Cube67 DI8 E - 4×M12

Expansion module
Form NPN



Cube67 DI8 E - 8×M8

Expansion module
Form NPN

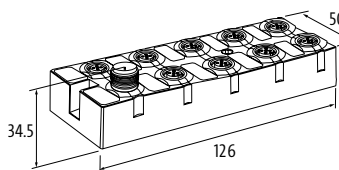
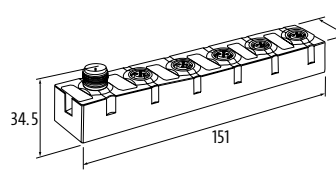
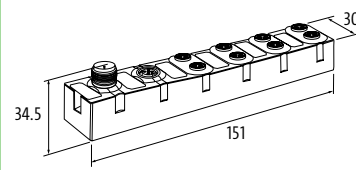

Approvals:  Listed

Order Data	Art-No.	Art-No.	Art-No.
DI16 - (E) NPN (8×M12)	56606		
DI8 - (E) NPN (4×M12)		56616	
DI8 - (E) NPN (8×M8)			56626
Internal communication			
Current consumption	max. 50 mA		max. 30 mA
LED display	US: sensor supply and internal supply voltage (green: OK); UA: actuator supply (green: OK)		
Connections			
Fieldbus	via internal system connection		
Sensor-system/actuator supply	via internal system connection (max. 2×4 A)		
I/O ports	M12 (female) 5-pole, A-coded	M8 (female) 3-pole, A-coded	
Input			
Sensor supply US	24 V DC (EN 61131-2), max. 200 mA (M12 female), short-circuit and overload protected		24 V DC (EN 61131-2), max. 200 mA (M8 female), short-circuit and overload protected
Type	for 3-wire sensors or mechanical switches, NPN, (EN 61131-2)		
Input filter	1 ms		
Parameterization			
PIN 2	Input/Diagnostic	-	
PIN 4	Input		
Diagnostic			
Communication status	via LED		
Diagnostic via LED	per module and channel		
Diagnostic via BUS	per module and channel		
Monitoring - under voltage	yes		
Monitoring - no voltage	yes		
Short-circuit and overload	yes		
General data			
Protection	IP67		
Mounting method	2-hole screw mounting		
Temperature range	0...+55 °C (storage temperature -20...+75 °C)		
Dimension drawing			
			
Notes			

CUBE67

Digital inputs/outputs (multifunctional)

Cube67 DIO16 C - 8xM12

Compact module
additional actuator supply 1 x 4 A



Approvals:  **UL**
Listed

Order Data	Art-No.	Art-No.
DIO16 - 0.5 A (C) 8xM12	56600	
DIO16 - 1.6 A (C) 8xM12		56640
Internal communication		
Current consumption	max. 50 mA	
LED display	US: sensor supply and internal supply voltage (green: OK); UA: actuator supply (green: OK)	
Terminating resistor	integrated into the module	
Connections		
Fieldbus	via internal system connection	
Sensor-system/actuator supply	via internal system connection (max. 2x4 A)	
I/O ports	M12 (female) 5-pole, A-coded	
Input		
Sensor supply US	24 V DC (EN 61131-2), max. 200 mA (M12 female), short-circuit and overload protected	
Type	for 3-wire sensors or mechanical switches, PNP	
Input filter	1 ms	
Output		
Actuator supply UA	24 V DC (EN 61131-2), via system connection (max. 4 A) + right actuators via supply right (max. 4 A)	
Switching current per output	max. 0.5 A (short-circuit and overload protected)	max. 1.6 A (short-circuit and overload protected)
Parameterization		
PIN 2	Input/Output/Diagnostic	
PIN 4	Input/Output	
Diagnostic		
Communication status	via LED	
Diagnostic via LED	per module and channel	
Diagnostic via BUS	per module and channel	
Monitoring - under voltage	yes	
Monitoring - no voltage	yes	
Short-circuit and overload	yes	
Actuator warning	per channel via LED and BUS	
General data		
Protection	IP67	
Mounting method	2-hole screw mounting	
Temperature range	0...+55 °C (storage temperature -20...+75 °C)	
Dimension drawing		

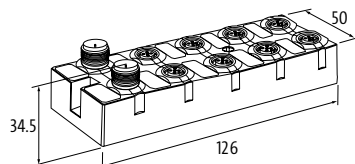

Notes

CUBE67

Digital inputs/outputs (multifunctional)

Cube67 DIO8 C - 4×M12

Compact module



Cube67 DIO8 C - 8×M12

Compact module



Approvals:  UL US Listed

Order Data	Art-No.	Art-No.
DIO8 - 0.5 A (C) 4×M12	56610	
DIO8 - 0.5 A (C) 8×M8		56620
Internal communication		
Current consumption	max. 50 mA	max. 30 mA
LED display	US: sensor supply and internal supply voltage (green: OK); UA: actuator supply (green: OK)	
Terminating resistor	integrated into the module	
Connections		
Fieldbus	via internal system connection	
Sensor-system/actuator supply	via internal system connection (max. 2×4 A)	
I/O ports	M12 (female) 5-pole, A-coded	M8 (female) 3-pole, A-coded
Input		
Sensor supply US	24 V DC (EN 61131-2), max. 200 mA (M12 female), short-circuit and overload protected	24 V DC (EN 61131-2), max. 200 mA (M8 female), short-circuit and overload protected
Type	for 3-wire sensors or mechanical switches, PNP	
Input filter	1 ms	
Output		
Actuator supply UA	24 V DC (EN 61131-2), via system connection (max. 4 A)	
Switching current per output	max. 0.5 A (short-circuit and overload protected)	
Parameterization		
PIN 2	Input/Output/Diagnostic	–
PIN 4	Input/Output	
Diagnostic		
Communication status	via LED	
Diagnostic via LED	per module and channel	
Diagnostic via BUS	per module and channel	
Monitoring - under voltage	yes	
Monitoring - no voltage	yes	
Short-circuit and overload	yes	
Actuator warning	per channel via LED and BUS	
General data		
Protection	IP67	
Mounting method	2-hole screw mounting	
Temperature range	0...+55 °C (storage temperature -20...+75 °C)	
Dimension drawing		

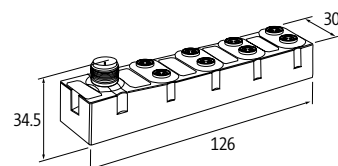
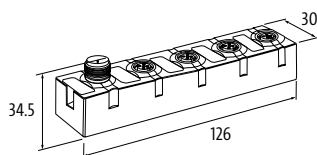

Notes

CUBE67

Digital inputs/outputs (multifunctional)

Approvals: UL US Listed

Cube67 DIO16 E - 8×M12

Expansion module



Cube67 DIO8 E - 4×M12

Expansion module



Cube67

Order Data	Art-No.	Art-No.
DIO16 - 0.5 A (E) 8×M12	56601	
DIO8 - 0.5 A (E) 4×M12		56611
Internal communication		
Current consumption	max. 50 mA	
LED display	US: sensor supply and internal supply voltage (green: OK); UA: actuator supply (green: OK)	
Connections		
Fieldbus	via internal system connection	
Sensor-system/actuator supply	via internal system connection (max. 2×4 A)	
I/O ports	M12 (female) 5-pole, A-coded	
Input		
Sensor supply US	24 V DC (EN 61131-2), max. 200 mA (M12 female), short-circuit and overload protected	
Type	for 3-wire sensors or mechanical switches, PNP	
Input filter	1 ms	
Output		
Actuator supply UA	24 V DC (EN 61131-2), via system connection (max. 4 A)	
Switching current per output	max. 0.5 A (short-circuit and overload protected)	
Parameterization		
PIN 2	Input/Output/Diagnostic	
PIN 4	Input/Output	
Diagnostic		
Communication status	via LED	
Diagnostic via LED	per module and channel	
Diagnostic via BUS	per module and channel	
Monitoring - under voltage	yes	
Monitoring - no voltage	yes	
Short-circuit and overload	yes	
Actuator warning	per channel via LED and BUS	
General data		
Protection	IP67	
Mounting method	2-hole screw mounting	
Temperature range	0...+55 °C (storage temperature -20...+75 °C)	
Dimension drawing		

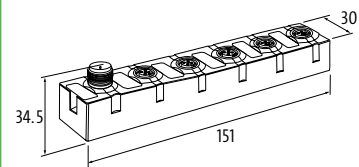
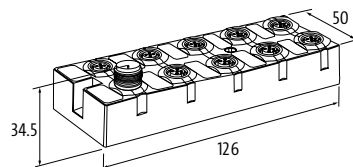

Notes

CUBE67

Digital inputs/outputs (multifunctional)

Approvals:  UL US Listed

Cube67 DIO8 E - 4×M12

Expansion module



Cube67 DIO8 E - 8×M8

Expansion module



Order Data	Art-No.	Art-No.
DIO8 - 1.0 A (E) 4×M12	56631	
DIO8 - 0.5 A (E) 8×M8		56621
Internal communication		
Current consumption	max. 50 mA	max. 30 mA
LED display	US: sensor supply and internal supply voltage (green: OK); UA: actuator supply (green: OK)	
Connections		
Fieldbus	via internal system connection	
Sensor-system/actuator supply	via internal system connection (max. 2×4 A)	
I/O ports	M12 (female) 5-pole, A-coded	M8 (female) 3-pole, A-coded
Input		
Sensor supply US	24 V DC (EN 61131-2), max. 200 mA (M12 female), short-circuit and overload protected	24 V DC (EN 61131-2), max. 200 mA (M8 female), short-circuit and overload protected
Type	for 3-wire sensors or mechanical switches, PNP	
Input filter	1 ms	
Output		
Actuator supply UA	24 V DC (EN 61131-2), via system connection (max. 4 A)	
Switching current per output	max. 1 A (short-circuit and overload protected)	max. 0.5 A (short-circuit and overload protected)
Parameterization		
PIN 2	Input/Output/Diagnostic	–
PIN 4	Input/Output	
Diagnostic		
Communication status	via LED	
Diagnostic via LED	per module and channel	
Diagnostic via BUS	per module and channel	
Monitoring - under voltage	yes	
Monitoring - no voltage	yes	
Short-circuit and overload	yes	
Actuator warning	per channel via LED and BUS	
General data		
Protection	IP67	
Mounting method	2-hole screw mounting	
Temperature range	0...+55 °C (storage temperature -20...+75 °C)	
Dimension drawing		

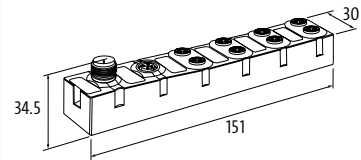
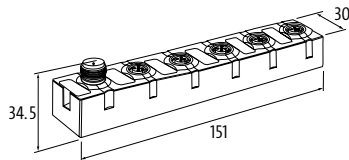

Notes

CUBE67

Digital inputs/outputs (multifunctional)

Approvals:

Cube67 DIO8 C - 4xM8

 Compact module
4-pole

Cube67 DIO8 E - 0.5 A 8xM8

 Expansion module
4-pole

Cube67

Contact layout

Female

PIN 1: Us: +24 V
PIN 2: DIO 0.5 A 0.x
PIN 3: 0 V DC
PIN 4: DIO 0.5 A 1.x

Order Data	Art-No.	Art-No.
DIO8 - 0.5 A (C) 4xM8	56627	
DIO16 - 0.5 A (E) 8xM8		56625

Internal communication	
Current consumption	max. 30 mA
LED display	US: sensor supply and internal supply voltage (green: OK); UA: actuator supply (green: OK)
Connections	
Fieldbus	via internal system connection
Sensor-system/actuator supply	via internal system connection (max. 2x4 A)
I/O ports	M8 (female), 4-pole, A-coded
Input	
Sensor supply US	24 V DC (EN 61131-2), max. 200 mA (M8 female), short-circuit and overload protected
Type	for 3-wire sensors or mechanical switches, PNP
Input filter	1 ms
Output	
Actuator supply UA	24 V DC (EN 61131-2), via system connection (max. 4 A)
Switching current per output	max. 0.5 A (short-circuit and overload protected)
Parameterization	
PIN 4	Input/Output
PIN 2	Input/Output/Diagnostic
Diagnostic	
Communication status	via LED
Diagnostic via LED	per module and channel
Diagnostic via BUS	per module and channel
Monitoring - under voltage	yes
Monitoring - no voltage	yes
Short-circuit and overload	yes
Actuator warning	per channel via LED and BUS
General data	
Protection	IP67
Mounting method	2-hole screw mounting
Temperature range	0...+55 °C (storage temperature -20...+75 °C)
Dimension drawing	

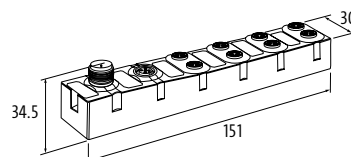
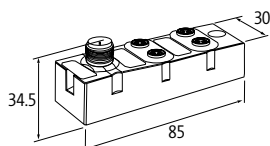

CUBE67

Digital inputs/outputs (multifunctional)

Cube67 DIO32 E - 16×M12

Expansion module



Cube67 DIO16 DO16 E - 1.6/2 A 16×M12

Expansion module



Order Data	Art-No.	Art-No.
DIO32 - 0.5 A (E) 16×M12	56642	
DIO16 - 1.6 A DO16 - 2 A (E) 16×M12		56641
Internal communication		
Current consumption	max. 60 mA	max. 50 mA
LED display	US: sensor supply and internal supply voltage (green: OK); UA: actuator supply (green: OK)	
Connections		
Fieldbus	via internal system connection	
Sensor-system/actuator supply	via internal system connection (max. 2×4 A)	
I/O ports	M12 (female) 5-pole, A-coded	
Input		
Sensor supply US	24 V DC (EN 61131-2), max. 200 mA (M12 female), short-circuit and overload protected	
Type	for 3-wire sensors or mechanical switches, PNP	
Input filter	1 ms	
Output		
Actuator supply (8×M12 left side)	24 V DC (EN 61131-2), via 7/8" male (max. 1 × 9 A)	24 V DC (EN 61131-2), via 7/8" male (max. 2 × 9 A)
Actuator supply (8×M12 right side)	24 V DC (EN 61131-2), via 7/8" male (max. 1 × 9 A)	24 V DC (EN 61131-2), via 7/8" male (max. 2 × 9 A)
Switching current per output (8×M12 left)	max. 0.5 A (short-circuit and overload protected)	max. 1.6 A (short-circuit and overload protected), coincidence factor 50% per port
Switching current per output (8×M12 right)	max. 0.5 A (short-circuit and overload protected)	max. 2 A (short-circuit and overload protected), coincidence factor 50% per port
Parameterization		
PIN 2 (8 × M12 left side)	Input/Output/Diagnostic	
PIN 4 (8 × M12 left side)	Input/Output	
PIN 2 (8 × M12 right side)	Input/Output/Diagnostic	Output
PIN 4 (8 × M12 right side)	Input/Output	Output
Diagnostic		
Communication status	via LED	
Diagnostic via LED	per module and channel	
Diagnostic via BUS	per module and channel	
Monitoring - under voltage	yes	
Monitoring - no voltage	yes	
Short-circuit and overload	yes	
Actuator warning	per channel via LED and BUS	
General data		
Protection	IP67	
Mounting method	4 hole screw mounting	
Temperature range	0...+55 °C (storage temperature -20...+75 °C)	

Dimension drawing

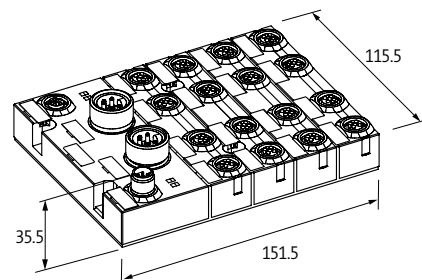
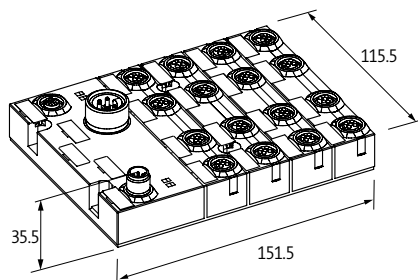

CUBE67

Terminal modules

– Digital inputs/outputs (multifunctional)

– Digital inputs

Cube67 DIO8/DI8 E (TB-Box)

Expansion module



Cube67 DIO8/DI8 E (TB-Box)

Expansion module with additional potential terminals

Cube67 DIO8/DI8 E (TB-Rail)

Expansion module



Order Data	Art-No.	Art-No.	Art-No.
DIO8/DI8 - (E) TB-Box	56681	5668100	
DIO8/DI8 - (E) TB-Rail			cULus 56691

Internal communication	
Current consumption	max. 50 mA
LED display	US: sensor supply and internal supply voltage (green: OK); UA: actuator supply (green: OK)
Connections	
Fieldbus	via internal system connection
Sensor-system/actuator supply	via internal system connection (max. 2x4 A)
I/O ports	16 x Spring clamp plug-in terminals, max. 2.5 mm ²
Input	
Sensor supply US	24 V DC (EN 61131-2), max. 8 x 200 mA
Type	for 3-wire sensors or mechanical switches, PNP
Input filter	1 ms
Output	
Actuator supply UA	24 V DC (EN 61131-2), via system connection (max. 4 A)
Switching current per output	max. 0.5 A (short-circuit and overload protected)
Parameterization	
Terminal row X0 (8 channels)	Input
Terminal row X1 (8 channels)	Input/Output
Diagnostic	
Communication status	via LED
Diagnostic via LED	per module and channel
Diagnostic via BUS	per module and channel
Monitoring - under voltage	yes
Monitoring - no voltage	yes
Short-circuit and overload	yes
Actuator warning	per channel via LED and BUS
General data	
Protection	IP66
Mounting method	screw fixing
Temperature range	0...+55 °C (storage temperature -20...+75 °C)
Dimension drawing	

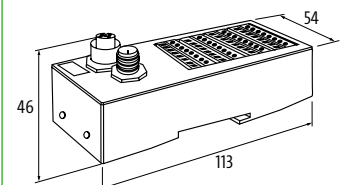
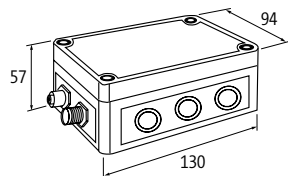

Notes

CUBE67

Function modules

– multifunctional

– IO-Link Master

IO-Link

Approvals:  Listed

Cube67+ DIO12 IOL4 - E 8×M12

Expansion module



Order Data	Art-No.
DIO12/IOL4 - (E) 8×M12	56766
Internal communication	
Current consumption	max. 100 mA
LED display	US: sensor supply (green: OK); IOL: (green: OK); UA: actuator supply (green: OK)
Connections	
Fieldbus	via internal system connection
Sensor-system/actuator supply	via internal system connection (max. 2×4 A)
I/O ports	M12 (female) 5-pole, A-coded
IO-Link	
IO-Link	4 × Master
Operating modes	COM1; COM2; COM3 (automatic)
Transfer parameters	32 Byte (via IO-Link Port)
Port class	Class A + B (not galvanically separated)
Specification	IO-Link Master V1.12
Input	
Sensor supply US	24 V DC (EN 61131-2), max. 200 mA (port 0...3); max. 700 mA (port 4...7)
Type	for 3-wire sensors or mechanical switches, PNP
Input filter	1 ms
Output	
Actuator supply UA	24 V DC (EN 61131-2), via system connection (max. 4 A)
Switching current per output	max. 1.6 A (short-circuit and overload protected)
Parameterization	
PIN 2	Input/Output/Diagnostic
PIN 4	Input/Output (port 0...3); IO-Link Master (port 4...7)
Diagnostic	
Communication status	via LED
Diagnostic via LED	per module and channel
Diagnostic via BUS	per module and channel
Monitoring - under voltage	yes
Monitoring - no voltage	yes
Short-circuit and overload	yes
Actuator warning	per channel via LED and BUS
General data	
Protection	IP67
Mounting method	2-hole screw mounting
Temperature range	0...+55 °C (storage temperature -20...+75 °C)
Dimension drawing	

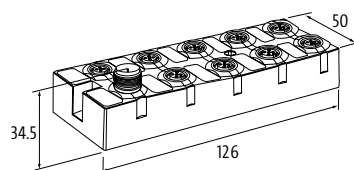

Notes	
	Cube67+ modules can only be operated on Cube67+, EtherNet/IP, Profibus + ProfiNet bus nodes.

CUBE67

Function modules

– Counter module with preprocessing

Approvals: UL Listed

Cube67 CNT2 - C 4xM12

Compact module



Order Data	Art-No.
Compact module	56750
Internal communication	
Current consumption	max. 50 mA
LED display	US: sensor supply and internal supply voltage (green: OK); UA: actuator supply (green: OK)
Connections	
Fieldbus	via internal system connection
Sensor-system/actuator supply	via internal system connection (max. 2x4 A)
I/O ports	M12 (female) 5-pole, A-coded
Input	
Sensor supply US	24 V DC (EN 61131-2), max. 200 mA (M12 female), short-circuit and overload protected
Type	for 3-wire sensors or mechanical switches, PNP
Input filter	1 ms
Output	
Actuator supply UA	24 V DC (EN 61131-2), via system connection (max. 4 A)
Switching current per output	max. 1.6 A (short-circuit and overload protected)
Counter	
Counter frequency	max. 300 kHz
Counter input	EN 61131-2
Counter depth	32 Bit (31 Bit + sign)
Diagnostic	
Communication status	via LED
Diagnostic via LED	per module and channel
Diagnostic via BUS	per module and channel
Monitoring - under voltage	yes
Monitoring - no voltage	yes
Short-circuit and overload	yes
Actuator warning	per channel via LED and BUS
General data	
Protection	IP67
Mounting method	2-hole screw mounting
Temperature range	0...+55 °C (storage temperature -20...+75 °C)
Dimension drawing	

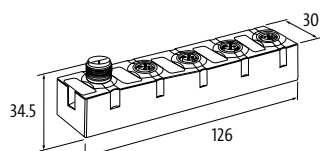

Notes

Cube67+ modules can only be operated on Cube67+, EtherNet/IP, Profibus + ProfiNet bus nodes.

CUBE67

Function modules

– Communication module

Approvals:  Listed

Cube67+ DIO4 RS232/485 - E 4×M12 MOVIMOT®

Expansion module
Serial interface

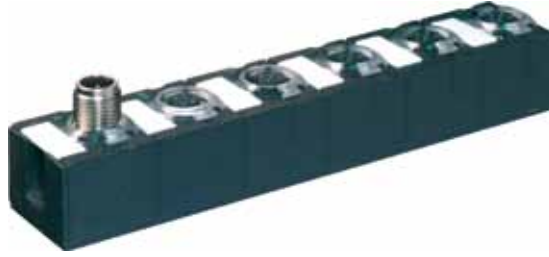

Order Data	Art-No.
DIO4 - (E) RS232/485 (4×M12) MOVIMOT®	56761
Internal communication	
Current consumption	max. 80 mA
LED display	US: sensor supply and internal supply voltage (green: OK); UA: actuator supply (green: OK)
Connections	
Fieldbus	via internal system connection
Sensor-system/actuator supply	via internal system connection (max. 2×4 A)
I/O ports	M12 (female) 5-pole, A-coded
Technical Data	
Transfer parameters	RS232: 230.4 kBaud, full duplex; RS485: 230.4 kBaud, half duplex
RS232-Type	galvanically separated, M12 female 5-pole, B-coded
RS485-Type	galvanically separated, M12 female 5-pole, B-coded
Input	
Sensor supply US	24 V DC (EN 61131-2), max. 200 mA (M12 female), short-circuit and overload protected
Type	for 3-wire sensors or mechanical switches, PNP
Input filter	1 ms
Output	
Actuator supply UA	24 V DC (EN 61131-2), via system connection (max. 4 A)
Switching current per output	max. 0.5 A (short-circuit and overload protected)
Parameterization	
PIN 2	Input/Output/Diagnostic
PIN 4	Input/Output
Diagnostic	
Communication status	via LED
Diagnostic via LED	per module and channel
Diagnostic via BUS	per module and channel
Monitoring - under voltage	yes
Monitoring - no voltage	yes
Short-circuit and overload	yes
Actuator warning	per channel via LED and BUS
General data	
Protection	IP67
Mounting method	2-hole screw mounting
Temperature range	0...+55 °C (storage temperature -20...+75 °C)
Dimension drawing	

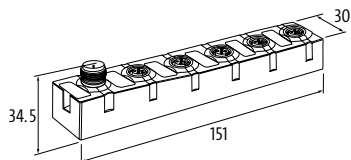

Notes
Cube67+ modules can only be operated on Cube67+, EtherNet/IP, Profibus + ProfiNet bus nodes.

CUBE67

Analog inputs

– Voltage/current

Cube67 AI4 C - 4×M12

Compact module
Voltage

Cube67 AI4 C - 4×M12

Compact module
Current

Cube67 AI4 E - 4×M12

Expansion module
Voltage

Cube67 AI4 E - 4×M12

Expansion module
Current



Order Data	Art-No.	Art-No.	Art-No.	Art-No.
AI4 - (C) 4×M12 (U)	cULus	56700		
AI4 - (C) 4×M12 (I)			cULus	56730
AI4 - (E) 4×M12 (U)			cULus	56701
AI4 - (E) 4×M12 (I)				56731
Internal communication				
Current consumption	max. 50 mA			
LED display	US: sensor supply and internal supply voltage (green: OK); UA: actuator supply (green: OK)			
Connections				
Fieldbus	via internal system connection			
Sensor-system/actuator supply	via internal system connection (max. 2×4 A)			
I/O ports	M12 (female) 5-pole, A-coded			
Input				
Conversion time (analog)	approx. 2 ms (per channel)			
Sensor supply US	24 V DC (EN 61131-2), max. 200 mA (M12 female), short-circuit and overload protected			
Resolution (analog)	15 Bit + sign	15 Bit	15 Bit + sign	15 Bit
Accuracy	max. ±0.5% (of range limit)			
Voltage inputs				
Input resistor	approx. 1 MOhm, differential input	–	approx. 1 MOhm, differential input	–
Input range	±10 V DC, 0...10 V DC	–	±10 V DC, 0...10 V DC	–
Current input signals				
Load	–	approx. 300 Ohm, differential input	–	approx. 300 Ohm, differential input
Input range	–	0...20 mA, 4...20 mA	–	0...20 mA, 4...20 mA
Diagnostic				
Communication status	via LED			
Diagnostic via LED	per module and channel			
Diagnostic via BUS	per module and channel			
Monitoring - under voltage	yes			
Monitoring - no voltage	yes			
Short-circuit and overload	yes			
Actuator warning	per channel via LED and BUS			
Wire break upper/lower limit overload	per channel via LED and BUS			
General data				
Protection	IP67			
Mounting method	2-hole screw mounting			
Temperature range	0...+55 °C (storage temperature -20...+75 °C)			
Dimension drawing				
Notes				

CUBE67

Analog inputs

– for resistors and temperature

– for thermo elements

Cube67 AI4 C (RTD) - 4×M12

Compact module
for resistors and temperature



Cube67 AI4 C (TH) - 4×M12

Compact module
for thermo elements

Cube67 AI4 E (RTD) - 4×M12

Expansion module
for resistors and temperature



Cube67 AI4 E (TH) - 4×M12

Expansion module
for thermo elements

Order Data	Art-No.	Art-No.	Art-No.	Art-No.
AI4 - (C) 4×M12 (RTD)	cUlus	56740		
AI4 - (C) 4×M12 (TH)		cUlus	56748	
AI4 - (E) 4×M12 (RTD)			56741	
AI4 - (E) 4×M12 (TH)				56749

Internal communication

Current consumption	max. 50 mA
LED display	US: sensor supply and internal supply voltage (green: OK); UA: actuator supply (green: OK)

Connections

Fieldbus	via internal system connection
Sensor-system/actuator supply	via internal system connection (max. 2×4 A)
I/O ports	M12 (female) 5-pole, A-coded

Input

Input	Art-No. 56740	Art-No. 56748	Art-No. 56741	Art-No. 56749
Sensor type	Pt100, 200, 500, 1000; Ni100, 120, 200, 500, 1000; R 0...3000 Ohm	K, N, J, E, R	Pt100, 200, 500, 1000; Ni100, 120, 200, 500, 1000; R 0...3000 Ohm	K, N, J, E, R
Conversion time (analog)	approx. 58 ms per channel	approx. 65 ms per channel	approx. 58 ms per channel	approx. 65 ms per channel
Resolution (analog)	15 Bit + sign			
Accuracy	max. ±0.5% (of range limit)			
Accuracy (Ni)	max. ±1% (of range limit)	–	max. ±1% (of range limit)	–
Connection	2-, 3-, 4-wire technology	2-wire technology	2-, 3-, 4-wire technology	2-wire technology
Cold junction compensation	–	inside M12 connector	–	inside M12 connector

Diagnostic

Communication status	via LED
Diagnostic via LED	per module and channel
Diagnostic via BUS	per module and channel
Monitoring - under voltage	yes
Monitoring - no voltage	yes
Short-circuit and overload	yes
Actuator warning	per channel via LED and BUS
Wire break upper/lower limit overload	per channel via LED and BUS

General data

Protection	IP67
Mounting method	2-hole screw mounting
Temperature range	0...+55 °C (storage temperature -20...+75 °C)

Dimension drawing

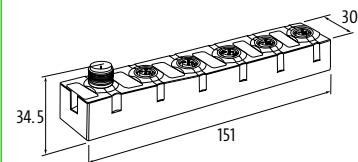
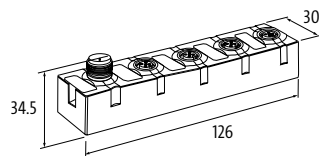

Notes

CUBE67

Analog outputs

– Voltage/current

Cube67 AO4 C 4×M12

Compact module
Voltage

Cube67 AO4 C 4×M12

Compact module
Current

Cube67 AO4 E 4×M12

Expansion module
Voltage

Cube67 AO4 E 4×M12

Expansion module
Current



Order Data	Art-No.	Art-No.	Art-No.	Art-No.
AO4 - (C) 4×M12 (U)	cULus	56710		
AO4 - (C) 4×M12 (I)		cULus	56720	
AO4 - (E) 4×M12 (U)			56711	
AO4 - (E) 4×M12 (I)				56721
Internal communication				
Current consumption	max. 50 mA			
LED display	US: sensor supply and internal supply voltage (green: OK); UA: actuator supply (green: OK)			
Connections				
Fieldbus	via internal system connection			
Sensor-system/actuator supply	via internal system connection (max. 2×4 A)			
I/O ports	M12 (female) 5-pole, A-coded			
Output				
Supply voltage	24 V DC (EN 61131-2), via system connection (max. 4 A)			
Conversion time (analog)	approx. 1 ms (per channel)			
Actuator supply UA	24 V DC (EN 61131-2), max. 1.6 A per M12 female, (short-circuit and overload protected)			
Resolution (analog)	11 Bit + sign	11 Bit	11 Bit + sign	11 Bit
Accuracy	max. ±0.5% (of range limit)			
Voltage output signals				
Load	min. 500 Ohm	–	min. 500 Ohm	–
Input range	±10 V DC, 0...10 V DC	–	±10 V DC, 0...10 V DC	–
Current outputs				
Load	–	max. 500 Ohm	–	max. 500 Ohm
Input range	–	0...20 mA, 4...20 mA	–	0...20 mA, 4...20 mA
Diagnostic				
Communication status	via LED			
Diagnostic via LED	per module and channel			
Diagnostic via BUS	per module and channel			
Monitoring - under voltage	yes			
Monitoring - no voltage	yes			
Short-circuit and overload	yes			
Actuator warning	per channel via LED and BUS			
Wire break upper/lower limit overload	per channel via LED and BUS			
General data				
Protection	IP67			
Mounting method	2-hole screw mounting			
Temperature range	0...+55 °C (storage temperature -20...+75 °C)			
Dimension drawing				

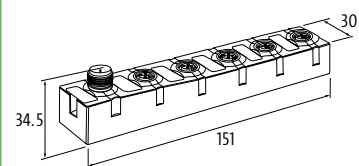
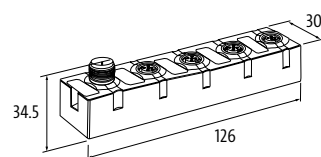

Notes

CUBE67

Safe outputs (Safety)

- passive safety
- Output groups up to PLd (EN ISO 13849-1) can be switched off via safety relays

Approvals:  Listed

Cube67 DO6/DO6 - E 6xM12 (K3)

Expansion module



Order Data	Art-No.
DO6/DO6 - (E) 6xM12 (K3)	56605
Internal communication	
Current consumption	max. 50 mA
LED display	US: sensor supply and internal supply voltage (green: OK); UA: actuator supply (green: OK)
Connections	
Fieldbus	via internal system connection
Sensor-system/actuator supply	via internal system connection (max. 1x4 A) / actuators via external cable (max. 4x2 A)
I/O ports	M12 (female) 5-pole, A-coded
Output	
Actuator supply UA	24 V DC (EN 61131-2), 2 circuits, (max. 2 x 4 A)
Switching current per output	max. 1.6 A (short-circuit and overload protected)
Diagnostic	
Communication status	via LED
Diagnostic via LED	per module and channel
Diagnostic via BUS	per module and channel
Monitoring - under voltage	yes
Monitoring - no voltage	yes
Short-circuit and overload	yes
Actuator warning	per channel via LED and BUS
General data	
Protection	IP67
Mounting method	2-hole screw mounting
Temperature range	0...+55 °C (storage temperature -20...+70 °C)
Dimension drawing	

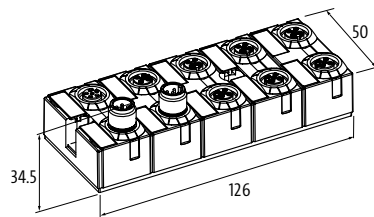

Notes

CUBE67

Function modules

– Hygienic Design

– multifunctional

– IP69K

 IO-Link

Cube67+ DIO12 IOL4 - E 8xM12 HD

Expansion module
IO-Link Master



Order Data	Art-No.
DIO12/IOL4 - (E) 8xM12	5676660
Internal communication	
Current consumption	max. 100 mA
LED display	US: sensor supply (green: OK); IOL: (green: OK); UA: actuator supply (green: OK)
Connections	
Fieldbus	via internal system connection
Sensor-system/actuator supply	via internal system connection (max. 2x4 A)
I/O ports	M12 (female) 5-pole, A-coded
IO-Link	
IO-Link	4 x Master
Operating modes	COM1; COM2; COM3 (automatic)
Transfer parameters	32 Byte (via IO-Link Port)
Port class	Class A + B (not galvanically separated)
Specification	IO-Link Master V1.12
Input	
Sensor supply US	24 V DC (EN 61131-2), max. 200 mA (port 0...3); max. 700 mA (port 4...7)
Type	for 3-wire sensors or mechanical switches, PNP
Input filter	1 ms
Output	
Actuator supply UA	24 V DC (EN 61131-2), via system connection (max. 4 A)
Switching current per output	max. 1.6 A (short-circuit and overload protected)
Parameterization	
PIN 2	Input/Output/Diagnostic
PIN 4	Input/Output (port 0...3); IO-Link Master (port 4...7)
Diagnostic	
Communication status	via LED
Diagnostic via LED	per module and channel
Diagnostic via BUS	per module and channel
Monitoring - under voltage	yes
Monitoring - no voltage	yes
Short-circuit and overload	yes
Actuator warning	per channel via LED and BUS
General data	
Protection	IP69K
Mounting method	2-hole screw mounting
Temperature range	0...+55 °C (storage temperature -20...+75 °C)
Dimension drawing	

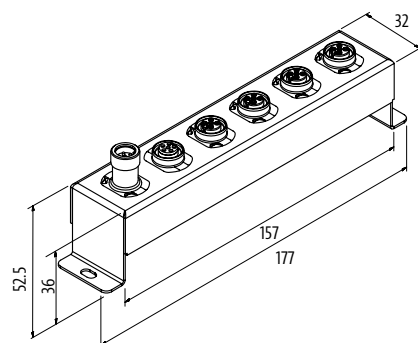

CUBE67

Hygienic Design

– multifunctional

– IP69K

Cube67 DIO8 E - 4×M12 HD

Expansion module



Cube67 DIO16 E - 8×M12 HD

Expansion module



Order Data	Art-No.	Art-No.
DIO8 - 0.5 A (E) 4×M12	5661160	
DIO16 - 0.5 A (E) 8×M12		5660160
Internal communication		
Current consumption	max. 50 mA	
LED display	US: sensor supply and internal supply voltage (green: OK); UA: actuator supply (green: OK)	
Connections		
Fieldbus	via internal system connection	
Sensor-system/actuator supply	via internal system connection (max. 2×4 A)	
I/O ports	M12 (female) 5-pole, A-coded	
Input		
Sensor supply US	24 V DC (EN 61131-2), max. 200 mA (M12 female), short-circuit and overload protected	
Type	for 3-wire sensors or mechanical switches, PNP	
Input filter	1 ms	
Output		
Actuator supply UA	24 V DC (EN 61131-2), via system connection (max. 4 A)	
Switching current per output	max. 0.5 A (short-circuit and overload protected)	
Parameterization		
PIN 2	Input/Output/Diagnostic	
PIN 4	Input/Output	
Diagnostic		
Communication status	via LED	
Diagnostic via LED	per module and channel	
Diagnostic via BUS	per module and channel	
Monitoring - under voltage	yes	
Monitoring - no voltage	yes	
Short-circuit and overload	yes	
Actuator warning	per channel via LED and BUS	
General data		
Protection	IP69K	
Mounting method	2-hole screw mounting	
Temperature range	0...+55 °C (storage temperature -20...+75 °C)	
Dimension drawing		

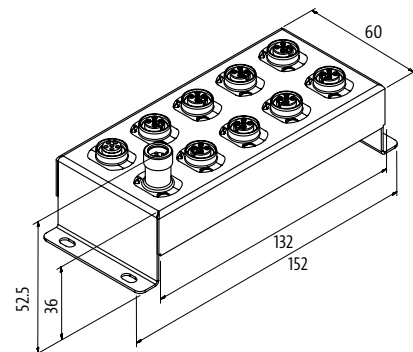
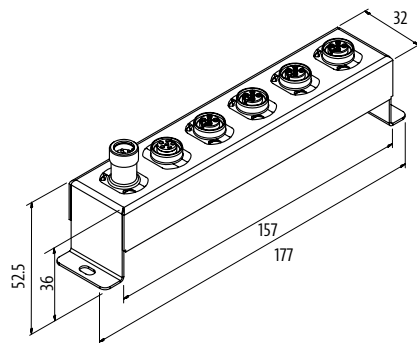

Notes

CUBE67

Digital outputs

– with open ended wires

Cube67 DO8 - Valve

Expansion module

Cube67 DO16 - E Valve

Expansion module

Cube67 DO32 - E Valve

Expansion module



Approvals:  UL Listed

Order Data	Art-No.	Art-No.	Art-No.
DO8 - 0.5 A (E) 0.5 m (open cable)	56655		
DO16 - 60 mA (E) 0.5 m (open cable)		56651	
DO32 - 0.5 A (E) 0.5 m (open cable)			56656
Internal communication			
Current consumption	max. 50 mA		
LED display	US: sensor supply and internal supply voltage (green: OK); UA: actuator supply (green: OK)		
Connections			
Fieldbus	via internal system connection		
Sensor-system/actuator supply	via internal system connection (max. 2x4 A)		
I/O ports	Open cable		
Output			
Actuator supply UA	24 V DC (EN 61131-2), via system connection (max. 4 A)		
Switching current per output	max. 0.5 A (short-circuit and overload protected)	max. 60 mA (short-circuit and overload protected)	max. 0.5 A (short-circuit and overload protected)
Cables			
No./diameter of wires	10 × 0.34 mm ²	18 × 0.25 mm ²	36 × 0.14 mm ²
Material (jacket)	PUR	PVC	
Cable length	0.5 m		
Diagnostic			
Communication status	via LED		
Diagnostic via LED	per module		
Diagnostic via BUS	per module and channel		
Monitoring - under voltage	yes		
Monitoring - no voltage	yes		
Short-circuit and overload	yes		
Actuator warning	per channel via BUS		
General data			
Protection	IP67		
Mounting method	2-hole screw mounting		
Temperature range	0...+55 °C (storage temperature -20...+75 °C)		
Dimension drawing			

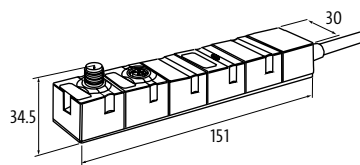

Notes

CUBE67

Digital inputs/outputs (multifunctional)

Cube67 DIO8 E - Cable

Expansion module



Order Data	Art-No.	Art-No.
DIO8 - 60 mA (E) 0.5 m (open cable)	cUlus	56661
DIO8 - 60 mA (E) 2 m (open cable)		5666100
Internal communication		
Current consumption	max. 30 mA	
LED display	US: sensor supply and internal supply voltage (green: OK); UA: actuator supply (green: OK)	
Connections		
Fieldbus	via internal system connection	
Sensor-system/actuator supply	via internal system connection (max. 2x4 A)	
I/O ports	Open cable	
Input		
Sensor supply US	24 V DC (EN 61131-2), max. 1.6 A	
Type	for 3-wire sensors or mechanical switches, PNP	
Input filter	1 ms	
Output		
Actuator supply UA	24 V DC (EN 61131-2), via system connection (max. 4 A)	
Switching current per output	max. 60 mA (short-circuit and overload protected)	
Cables		
No./diameter of wires	10 × 0.34 mm ²	
Material (jacket)	PVC	
Cable length	0.5 m	2.0 m
Parameterization		
I/O channels	Input/Output	
Diagnostic		
Communication status	via LED	
Diagnostic via LED	per module	
Diagnostic via BUS	per module and channel	
Monitoring - under voltage	yes	
Monitoring - no voltage	yes	
Short-circuit and overload	yes	
Actuator warning	per channel via BUS	
General data		
Protection	IP67	
Mounting method	2-hole screw mounting	
Temperature range	0...+55 °C (storage temperature -20...+75 °C)	
Dimension drawing		

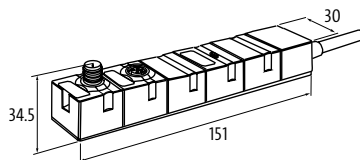

Notes

Digital inputs/outputs (multifunctional)

Cube67 DIO16 E - Cable

Expansion module

Cube67 DI16 DO16 E - Cable

Expansion module



Order Data	Art-No.	Art-No.	Art-No.
DIO16 - 0.5 A (E) 0.5 m (open cable)	cULus	56662	
DIO16 - 0.5 A (E) 1.5 m (open cable)		5666200	
DI16/DO16 - 0.5 A (E) 0.5 m (open cable)			56671
Internal communication			
Current consumption	max. 30 mA		max. 50 mA
LED display	US: sensor supply and internal supply voltage (green: OK); UA: actuator supply (green: OK)		
Connections			
Fieldbus	via internal system connection		
Sensor-system/actuator supply	via internal system connection (max. 2x4 A)		
I/O ports	Open cable		
Input			
Sensor supply US	24 V DC (EN 61131-2), max. 0.5 A		24 V DC (EN 61131-2), max. 0.2 A
Type	for 3-wire sensors or mechanical switches, PNP		
Input filter	1 ms		
Output			
Actuator supply UA	24 V DC (EN 61131-2), via system connection (max. 4 A)		
Switching current per output	max. 0.5 A (short-circuit and overload protected)		
Cables			
No./diameter of wires	20 x 0.14 mm ²		36 x 0.14 mm ²
Material (jacket)	PVC		
Cable length	0.5 m	1.5 m	0.5 m
Parameterization			
I/O channels	Input/Output		-
Diagnostic			
Communication status	via LED		
Diagnostic via LED	per module		
Diagnostic via BUS	per module and channel		
Monitoring - under voltage	yes		
Monitoring - no voltage	yes		
Short-circuit and overload	yes		
Actuator warning	per channel via BUS		
General data			
Protection	IP67		
Mounting method	2-hole screw mounting		
Temperature range	0...+55 °C (storage temperature -20...+75 °C)		
Dimension drawing			

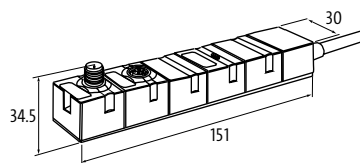

Notes

CUBE67

Digital inputs/outputs (multifunctional)

- Digital outputs

Cube67 D07 - E Cable M12

for Modlight70 Pro basic
Expansion module



Cube67 DIO8 E - Cable M12

Expansion module

Cube67 DIO8 - E M16 female

Expansion module



Order Data	Art-No.	Art-No.	Art-No.
D07 - 0.5 A (E) 0.5 m (M12)	Modlight70 Pro - M12 (female) 8-pole 5665503		
DIO8 - 60 mA (E) 0.5 m (M12)		cULus 5666201	
DIO8 - 0.5 A (E) M16		cULus 56663	
Internal communication			
Current consumption	max. 50 mA		max. 30 mA
LED display	US: sensor supply and internal supply voltage (green: OK); UA: actuator supply (green: OK)		
Connections			
Fieldbus	via internal system connection		
Sensor-system/actuator supply	via internal system connection (max. 2x4 A)		
I/O ports	Modlight70 Pro - M12 (female) 8-pole	M12 (male) 5-pole, A-coded	M16 (female)
Input			
Sensor supply US	–	24 V DC (EN 61131-2), max. 0.5 A	24 V DC (EN 61131-2), max. 200 mA
Type	–	for 3-wire sensors or mechanical switches, PNP	
Input filter	–	1 ms	
Output			
Actuator supply UA	24 V DC (EN 61131-2), via system connection (max. 4 A)		
Switching current per output	max. 0.5 A (short-circuit and overload protected)	max. 60 mA (short-circuit and overload protected)	max. 0.5 A (short-circuit and overload protected)
Cables			
No./diameter of wires	8 × 0.25 mm ²		–
Material (jacket)	PUR		–
Cable length	0.5 m		–
Parameterization			
I/O channels	7 outputs	Input/Output	
Diagnostic			
Communication status	via LED		
Diagnostic via LED	per module		
Diagnostic via BUS	per module and channel		
Monitoring - under voltage	yes		
Monitoring - no voltage	yes		
Short-circuit and overload	yes		
Actuator warning	per channel via BUS		
General data			
Protection	IP67		
Mounting method	2-hole screw mounting		
Temperature range	0...+55 °C (storage temperature -20...+75 °C)		
Dimension drawing			
Notes			

CUBE67

Safe outputs (Safety)

- passive safety
- Output groups up to PLd (EN ISO 13849-1) can be switched off via safety relays

Cube67 DO16 - C Valve (K3)

Compact module

Cube67 DO8 - C Valve (K3)

Compact module



Order Data	Art-No.	Art-No.
DO16 - 0.5 A Valve (C) 0.5 m (K3)	FESTO - CPV (SUB-D25) – cULus	56650
DO8 - 0.5 A Valve (C) 0.5 m (K3)		FESTO - CPV (SUB-D9) 5665003
Internal communication		
Current consumption	max. 50 mA	
LED display	US: sensor supply and internal supply voltage (green: OK); UA: actuator supply (green: OK)	
Connections		
Fieldbus	via internal system connection	
Sensor-system/actuator supply	via internal system connection (max. 1x4 A) / actuators via external cable (max. 4x2 A)	
I/O ports	FESTO - CPV (SUB-D25)	FESTO - CPV (SUB-D9)
Output		
Actuator supply UA	24 V DC (EN 61131-2), max. 4 x 2 A	
Switching current per output	max. 0.5 A (short-circuit and overload protected)	
Cables		
No./diameter of wires	4x4x0.14 mm ²	
Material (jacket)	PVC, cross-link safe	
Cable length	0.5 m	
Diagnostic		
Communication status	via LED	
Diagnostic via LED	per module	
Diagnostic via BUS	per module and channel	
Monitoring - under voltage	yes	
Monitoring - no voltage	yes	
Short-circuit and overload	yes	
Actuator warning	per channel via BUS	
General data		
Protection	IP67	
Mounting method	2-hole screw mounting	
Temperature range	0...+55 °C (storage temperature -20...+70 °C)	
Dimension drawing		

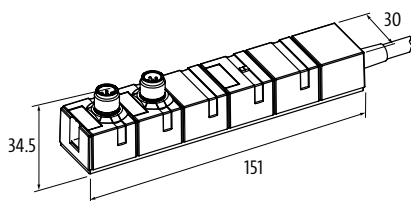

Notes

CUBE67

Digital outputs

Cube67 DO16 - C Valve

Compact module
(4 × actuator supply UA)



Cube67 DO32 - E Valve

Expansion module



Cube67 DO16 - E Valve











Expansion module

Order Data	Art-No.	Art-No.	Art-No.
DO16 - 0.5 A Valve (C) 0.5 m	SMC - SUB-D25 SMC - Series SV/VQ FESTO - MPA (SUB-D25) FESTO - CPV (SUB-D25)	5665000 5665002 5665001 5665004	
DO32 - 0.5 A Valve (E)		MAC - SUB-D44	56657
DO16 - 0.5 A Valve (E)			MAC - SUB-D44 56653
Internal communication			
Current consumption	max. 50 mA		
LED display	US: sensor supply and internal supply voltage (green: OK); UA: actuator supply (green: OK)		
Connections			
Fieldbus	via internal system connection		
Sensor-system/actuator supply	via internal system connection (max. 1×4 A) / actuators via external cable (max. 4×2 A)	via internal system connection (max. 2×4 A)	
I/O ports	SMC - SUB-D25	MAC - SUB-D44	
Output			
Actuator supply UA	24 V DC (EN 61131-2), max. 4 × 2 A	24 V DC (EN 61131-2)	
Switching current per output	max. 0.5 A (short-circuit and overload protected)		
Cables			
No./diameter of wires	4×4×0.14 mm ²	–	
Material (jacket)	PVC, cross-link safe	–	
Cable length	0.5 m	–	
Diagnostic			
Communication status	via LED		
Diagnostic via LED	per module		
Diagnostic via BUS	per module and channel		
Monitoring - under voltage	yes		
Monitoring - no voltage	yes		
Short-circuit and overload	yes		
Actuator warning	per channel via BUS		
General data			
Protection	IP67		
Mounting method	2-hole screw mounting		
Temperature range	0...+55 °C (storage temperature -20...+70 °C)		
Dimension drawing			
Notes			

Versions			Art-No.
	based of: Art.-No. 56655		
	Multipole plug (70 mA)	FESTO - CPV	5665500
	Multipole plug (70 mA)	FESTO - CPV (SUB-D9)	5665501
	Multipole plug (0.5 A)	FESTO - MPA	5665502
	based of: Art.-No. 56651		
	Multipole plug (70 mA)	SMC - Series SV/VQ	5665119
	Multipole plug (0.5 A)	SMC - Series SV/VQ	5665120
	Multipole plug (0.5 A)	FESTO - CPV-VA (SUB-D25)	5665151
	based of: Art.-No. 56651		
	Multipole plug (70 mA)	FESTO - CPV (cULus-Listed)	5665100
	Multipole plug (70 mA)	PARKER - Series V	5665101
	Multipole plug (70 mA)	NORGREN - V20/22	5665110
	Multipole plug (70 mA)	NORGREN - VM10	5665111
	Multipole plug (70 mA)	NORGREN - V20/22	5665112
	Multipole plug (70 mA)	SMC - Series SV/VQ	5665113
	Multipole plug (70 mA)	SMC - M27	5665114
	Multipole plug (70 mA)	NORGREN - V20/220	5665115
	Multipole plug (0.5 A)	MAC Valves	5665116
	Multipole plug (70 mA)	FESTO - MPA	5665118
	Multipole plug (70 mA)	FESTO - VTSA	5665105
	Multipole plug (70 mA)	FESTO - CPV-SC (SUB-D15)	5665102
	Multipole plug (70 mA)	FESTO - CPV-SC (SUB-D26)	5665103
	Multipole plug (0.5 A)	HDM (SUB-D25)	5665106
	based of: Art.-No. 56656		
	Multipole plug (0.5 A)	NORGREN - VM10	5665600
	Multipole plug (0.5 A)	FESTO - MPA	5665601
	Multipole plug (0.5 A)	AVENTICS - HF03	5665602
	Multipole plug (0.5 A)	NORGREN - VM10	5665603
	Multipole plug (0.5 A)	SMC - Series SV	5665604
	Multipole plug (0.5 A)	FESTO - CPA	5665605
	Multipole plug (0.5 A)	AVENTICS - HF04	5665621
	Multipole plug (0.5 A)	AVENTICS - HF02/03-LG	5665606
	Multipole plug (0.5 A)	SMC - M27	5665607
	Multipole plug (0.5 A)	MAC Valves (UL-Listed)	5665609
	Multipole plug (0.5 A)	VESTA (SUB-D37)	5665610
	Multipole plug (0.5 A)	VESTA (SUB-D25)	5665611
	Multipole plug (0.5 A)	FESTO - VTSA	5665613
	Multipole plug (0.5 A)	SMC - SUB-D25	5665614
	Multipole plug (0.5 A)	FESTO - CPA-SC	5665615
	Multipole plug (0.5 A)	FESTO - MPA-L	5665616
	Multipole plug (0.5 A)	AVENTICS - HF02/03-LG	5665617
	Multipole plug (0.5 A)	Numatics Generation 2000 (UL-Listed)	5665618
	Multipole plug (0.5 A)	FESTO - MPA-L	5665619
	based of: Art.-No. 56671		
	DI16/DO16 - 0.5 A (E) AMP (0.5 m)	with AMP connector 32-pole (female)	5667100
	DI16/DO16 - 0.5 A (E) SUB-D37 (0.5 m)	with SUB-D37 (female)	5667101
	DI16/DO16 - 0.5 A (E) SUB-D37 (5 m)	with SUB-D37 (female)	5667102
	DI16/DO16 - 0.5 A E (0.72 m)	with open ended wires	5667103
	DI16/DO16 - 0.5 A E (2 m)	with open ended wires	5667104
	DI16/DO16 - 0.5 A E (3 m)	with open ended wires	5667106
	DI16/DO16 - 0.5 A E (5 m)	with open ended wires	5667105

CUBE67

Cube67

Labeling accessories			Art-No.
	Label plates 20 × 8 mm	(20 pieces per plate)	55318
	Label plates 20 × 8 mm (20 pieces per plate)	Safety	55316
Blind Plug/caps			Art-No.
	Screw plug M8 × 1 mm (for female) Plastic, hex without gasket	Quantity: 10 pcs.	3858627
	Screw plug M12 × 1 mm (for female) Plastic, hex without gasket	Quantity: 10 pcs.	58627
	Plastic, hex without gasket	Quantity: 4 pcs.	56952
	Screw plug M12 × 1 mm (for male) Plastic	Quantity: 4 pcs.	56951
	Screw plug 7/8" (for male) Plastic		55385
	Blind plug diagnostic M12 × 1 mm Bridge PIN 1 and PIN 2		7000-13481-000000
Connection accessories			Art-No.
	Ground strap 4 mm² 100 mm for screw (M4)		4000-71001-0410004
	T-coupler M12 – M12 Male straight - female straight straight, A-coded, 6-pole, shielded	Cube67 additional actuator power supply	7000-46101-000000
	T-coupler M12/M12, female/male straight, A-coded, 6-pole, shielded	Cube67 additional actuator power supply	7000-46091-000000

Connection accessories			Art-No.
	T-coupler 7/8"-7/8", female/male 5-pole		7000-50061-0000000
	Terminator M12 (male) straight, A-coded, 6-pole	Cube67	7000-15041-0000000
	Control cabinet entry system M12 straight, A-coded, 6-pole, shielded	Cube67	7000-46111-0000000
	Cube67 FSC Connector Set with mounting socket Han-Brid®, 6-pole - M12, 6-pole	Cable length (120 mm)	56953
	DIN-rail adapter	for bus nodes	56961
	DIN-rail adapter for extension modules	50 mm	56962
	DIN-rail adapter for extension modules	30 mm	56963
	Power distributor 4 x M12 for additional actuator supply		56955
	Repeater PROFIBUS DP + PROFIsafe 2 segments 3 segments		56960 56965

CUBE67

Cube67

Connection accessories			Art-No.
	<p>Male M12, field-wireable, screw terminals Analog input with integrated compensation</p>	Cube67	56945
	<p>Male M12, field-wireable, screw terminals Analog input with integrated compensation</p>	Cube67	56946
	<p>Male M12 Internal system connection</p>		56947
	<p>Female M12 Internal system connection with mounting socket</p>		56948
	<p>Female M12 Internal system connection</p>		56949

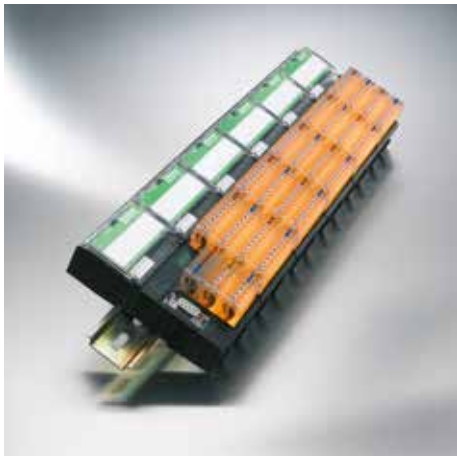

CUBE20 MODULAR I/O STATION IP20







- High channel density due to compact design
- Modular structure
- I/O connections with maintenance-free terminals

INNOVATIVE INSTALLATION TECHNOLOGY

Cube20 is an expandable modular fieldbus I/O system for control cabinets. It can be operated as a stand-alone unit or with a Cube67. Cube20 is consistently designed for the requirements of modern control cabinet wiring. High costs due to handling of many individual components can be reduced to a minimum with Cube20.



Cube20 I/O Modules

 <p>Bus nodes</p> <ul style="list-style-type: none"> • PROFIBUS DP • PROFINET IO • EtherNet/IP <p><i>Page 4.2.1</i></p>	 <p>System connection to Cube67</p> <p><i>Page 4.2.3</i></p>
 <p>Digital inputs</p> <p><i>Page 4.2.5</i></p>	 <p>Digital inputs/outputs</p> <p><i>Page 4.2.5</i></p>
 <p>Digital outputs</p> <p><i>Page 4.2.6</i></p>	 <p>Analog inputs</p> <p><i>Page 4.2.8</i></p>
 <p>Analog outputs</p> <p><i>Page 4.2.10</i></p>	

CUBE20

Bus Nodes

– Digital inputs



Cube20 BN-P DI8

PROFIBUS DP



Cube20 BN-PNIO DI8

PROFINET IO



Order Data	Art-No.	Art-No.
PROFIBUS DP	56001	
PROFINET IO		56006
Connections		
Fieldbus	PROFIBUS 12 Mbit/s; SUB-D9	Ethernet 10/100 Mbit/s; 2 × RJ45 (female)
Sensor-system/actuator supply	4 × Spring clamp plug-in terminals, max. 2.5 mm ² (max. 12 A)	
Internal system connection	4 × Spring clamp plug-in terminals, max. 2.5 mm ² (max. 12 A)	
I/O ports	8 × Spring clamp plug-in terminals, max. 2.5 mm ²	
Module Supply		
Operating voltage	24 V DC (EN 61131-2)	
Current consumption	max. 150 mA	
PROFIBUS		
Addressing	Rotary switch 0...99	–
PROFINET		
Addressing	–	DCP
Specification	–	V2.2, Conformance Class B
Cube system		
Module capacity	max. 15	
I/O capacity	max. 244 Byte (Input), max. 244 Byte (Output)	max. 1024 Byte (Input), max. 1024 Byte (Output)
Machine Option Management	yes	
Input		
Sensor supply US	24 V DC (EN 61131-2), max. 700 mA per module	
Type	PNP (EN 61131-2)	
Input filter	1 ms	
Galvanic isolation	500 V DC between I/O and system electronics	
Parameterization		
Terminal row X2 (4 channels)	Input	
Terminal row X3 (4 channels)	Input	
Diagnostic		
Communication status	via LED and BUS	
Diagnostic via LED	per module	
Diagnostic via BUS	per module and channel	
Monitoring - under voltage	yes	
Monitoring - no voltage	no	
Short circuit and overload	yes	
General data		
Protection	IP20	
Mounting method	DIN-rail mountable (EN 60715)	
Temperature range	0...+55 °C (storage temperature -20...+85 °C)	
Dimension drawing		

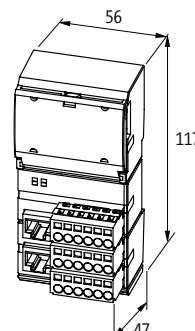
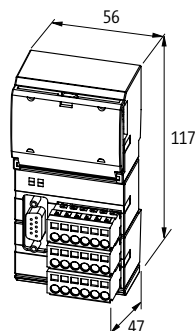

CUBE20

Bus Nodes

– Digital inputs

EtherNet/IP

Cube20 BN-E DI8

EtherNet/IP



Approvals:  Listed

Order Data	Art-No.
EtherNet/IP	56005
Connections	
Fieldbus	Ethernet 10/100 Mbit/s; 2 × RJ45 (female)
Sensor-system/actuator supply	4 × Spring clamp plug-in terminals, max. 2.5 mm ² (max. 12 A)
Internal system connection	4 × Spring clamp plug-in terminals, max. 2.5 mm ² (max. 12 A)
I/O ports	8 × Spring clamp plug-in terminals, max. 2.5 mm ²
Module Supply	
Operating voltage	24 V DC (EN 61131-2)
Current consumption	max. 150 mA
EtherNet/IP	
Addressing	DHCP, BOOTP or IP address by rotary switch
Cube system	
Module capacity	max. 15
I/O capacity	max. 504 Byte (Input), max. 500 Byte (Output)
Input	
Sensor supply US	24 V DC (EN 61131-2), max. 700 mA per module
Type	PNP (EN 61131-2)
Input filter	1 ms
Galvanic isolation	500 V DC between I/O and system electronics
Parameterization	
Terminal row X2 (4 channels)	Input
Terminal row X3 (4 channels)	Input
Diagnostic	
Communication status	via LED and BUS
Diagnostic via LED	per module
Diagnostic via BUS	per module and channel
Monitoring - under voltage	yes
Monitoring - no voltage	no
Short circuit and overload	yes
General data	
Protection	IP20
Mounting method	DIN-rail mountable (EN 60715)
Temperature range	0...+55 °C (storage temperature -20...+85 °C)
Dimension drawing	

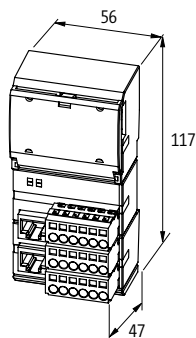

Notes

CUBE20

Cube20/67-Interface

– Digital inputs/outputs
(multifunctional)

– Cube67

Approvals: UL
Listed

Cube20 BN-67 DIO8

Power external



Cube20 BN-67 DIO8

M12 Power
via internal system connection

Order Data	Art-No.	Art-No.
Cube67 system connection	56450	564501
Connections		
Fieldbus	M12 (male) 6-pole	M12 (female) 6-pole
Sensor-system/actuator supply	4 × Spring clamp plug-in terminals, max. 2.5 mm ² (max. 12 A)	via internal system connection (max. 2×4 A)
I/O ports	8 × Spring clamp plug-in terminals, max. 2.5 mm ²	
Module Supply		
Operating voltage	24 V DC (EN 61131-2)	
Current consumption	max. 100 mA	
Cube system		
Module capacity	max. 3	
Input		
Sensor supply US	24 V DC (EN 61131-2), max. 700 mA per module, short-circuit and overload protected	
Type	PNP (EN 61131-2)	
Input filter	1 ms	
Galvanic isolation	500 V DC between I/O and system electronics	
Output		
Actuator supply UA	24 V DC (EN 61131-2), max. 12 A	24 V DC (EN 61131-2), max. 4 A
Switching current per output	max. 0.5 A (short-circuit and overload protected)	
Galvanic isolation	500 V DC between I/O and system electronics	
Lamp load	10 W	
Parameterization		
Terminal row X2 (4 channels)	Input/Output	
Terminal row X3 (4 channels)	Input/Output	
Diagnostic		
Communication status	via LED	
Diagnostic via LED	per module and channel (only outputs)	
Diagnostic via BUS	per module and channel	
Monitoring - under voltage	yes	
Monitoring - no voltage	no	
Short circuit and overload	yes	
General data		
Protection	IP20	
Mounting method	DIN-rail mountable (EN 60715)	
Temperature range	0...+55 °C (storage temperature -20...+85 °C)	
Dimension drawing		

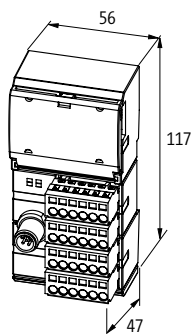

Notes

CUBE20

Cube20/67-Interface

– Cube67

Approvals:  UL US
Listed

Cube20/67-Interface



Order Data	Art-No.
Cube67 system connection	56140
Connections	
Fieldbus	M12 (female) 6-pole
Sensor-system/actuator supply	4 × Spring clamp plug-in terminals, max. 2.5 mm ² (max. 12 A)
I/O ports	8 × Spring clamp plug-in terminals, max. 2.5 mm ²
Module Supply	
Operating voltage	24 V DC (EN 61131-2)
Current consumption	max. 25 mA
Cube system	
Module capacity	max. 15
Sensor supply US	24 V DC (18...30.2 V DC) EN 61131-2, max. 4 A
Actuator supply UA	24 V DC (18...30.2 V DC) EN 61131-2, max. 4 A
Diagnostic	
Communication status	via LED
General data	
Protection	IP20
Mounting method	DIN-rail mountable (EN 60715)
Temperature range	0...+55 °C (storage temperature -20...+85 °C)
Dimension drawing	

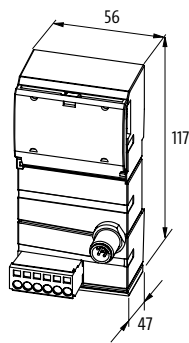

Notes

CUBE20

Digital inputs/outputs

Cube20 DI32 E
Expansion module



Cube20 DI16 DO16 E
Expansion module



Order Data	Art-No.	Art-No.
DI32 - (E)	cULus	56112
DI16/DO16 - (E)		56168
Internal communication		
Module Supply	via system connection	
Current consumption	max. 25 mA	
Connections		
Fieldbus	Ribbon cable connection	
Sensor-system/actuator supply	8 × Spring clamp plug-in terminals, max. 2.5 mm ² (max. 12 A)	
I/O ports	32 × Spring clamp plug-in terminals, max. 2.5 mm ²	
Input		
Sensor supply US	24 V DC (EN 61131-2), max. 700 mA per module	
Type	PNP (EN 61131-2)	
Input filter	1 ms	
Galvanic isolation	500 V DC between inputs and internal communication	
Output		
Actuator supply UA	–	24 V DC (EN 61131-2), max. 12 A
Galvanic isolation	–	500 V DC between outputs and internal communication
Switching current per output	–	max. 0.5 A (short-circuit and overload protected)
Lamp load	–	10 W
Diagnostic		
Communication status	via LED	
Diagnostic via LED	per module	per module and channel (only outputs)
Diagnostic via BUS	per module and channel	
Monitoring - under voltage	yes	
Monitoring - no voltage	no	
Short circuit and overload	yes	
General data		
Protection	IP20	
Mounting method	DIN-rail mountable (EN 60715)	
Temperature range	0...+55 °C (storage temperature -20...+85 °C)	

Dimension drawing

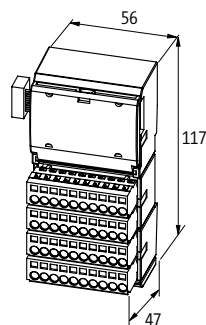

Notes

CUBE20

Digital outputs

Cube20 DO16 E - 2 A

Expansion module



Approvals:  Listed

Order Data	Art-No.
DO16 - 2 A (E)	56117
Internal communication	
Module Supply	via system connection
Current consumption	max. 25 mA
Connections	
Fieldbus	Ribbon cable connection
Sensor-system/actuator supply	8 × Spring clamp plug-in terminals, max. 2.5 mm ² (max. 12 A)
I/O ports	16 × Spring clamp plug-in terminals, max. 2.5 mm ²
Output	
Actuator supply UA	24 V DC (EN 61131-2), max. 12 A
Switching current per output	max. 2 A
Galvanic isolation	500 V DC between outputs and internal communication
Lamp load	40 W
Diagnostic	
Communication status	via LED
Diagnostic via LED	per module and channel
Diagnostic via BUS	per module and channel
Monitoring - under voltage	yes
Monitoring - no voltage	no
Short circuit and overload	yes
General data	
Protection	IP20
Mounting method	DIN-rail mountable (EN 60715)
Temperature range	0...+55 °C (storage temperature -20...+85 °C)
Dimension drawing	

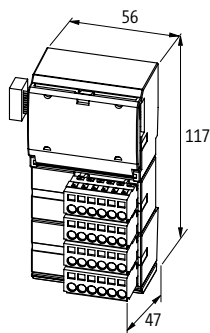

Notes

CUBE20

Digital outputs

Cube20 DO32 E Expansion module



Approvals:  UL
Listed

Cube20

Order Data	Art-No.
DO32 - (E)	56118
Internal communication	
Module Supply	via system connection
Current consumption	max. 25 mA
Connections	
Fieldbus	Ribbon cable connection
Sensor-system/actuator supply	8 × Spring clamp plug-in terminals, max. 2.5 mm ² (max. 12 A)
I/O ports	32 × Spring clamp plug-in terminals, max. 2.5 mm ²
Output	
Actuator supply UA	24 V DC (EN 61131-2), max. 12 A
Switching current per output	max. 0.5 A (short-circuit and overload protected)
Galvanic isolation	500 V DC between outputs and internal communication
Lamp load	10 W
Diagnostic	
Communication status	via LED
Diagnostic via LED	per module and channel
Diagnostic via BUS	per module and channel
Monitoring - under voltage	yes
Monitoring - no voltage	no
Short circuit and overload	yes
General data	
Protection	IP20
Mounting method	DIN-rail mountable (EN 60715)
Temperature range	0...+55 °C (storage temperature -20...+85 °C)
Dimension drawing	

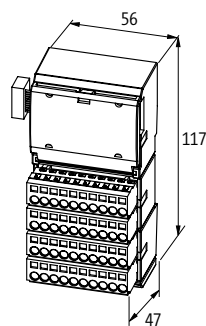

Notes

CUBE20

Analog inputs

– Voltage/current

Cube20 AI4 E

Expansion module
Voltage/current



Approvals:  Listed

Order Data	Art-No.
AI4 - (E)	56200
Internal communication	
Module Supply	via system connection
Current consumption	max. 25 mA from system, max. 60 mA externally (UI)
Connections	
Fieldbus	Ribbon cable connection
Sensor-system/actuator supply	4 × Spring clamp plug-in terminals, max. 2.5 mm ² (max. 12 A)
I/O ports	24 × Spring clamp plug-in terminals, max. 2.5 mm ²
Input	
Conversion time (analog)	max. 2 ms (per channel)
Resolution (analog)	15 Bit + sign
Accuracy	max. 0.3%
Connection	Differential voltage/current input
Voltage inputs	
Input resistor	min. 1 MOhm, (EN 61131-2)
Input range	±10 V DC, 0...10 V DC
Current input signals	
Load	max. 300 Ohm (20 mA), (EN 61131-2)
Input range	0...20 mA, 4...20 mA
Diagnostic	
Communication status	via LED
Diagnostic via LED	per module
Diagnostic via BUS	per module and channel
Monitoring - under voltage	yes
Monitoring - no voltage	no
Short circuit and overload	yes
Wire break upper/lower limit overload	per channel via LED and BUS
General data	
Protection	IP20
Mounting method	DIN-rail mountable (EN 60715)
Temperature range	0...+55 °C (storage temperature -40...+85 °C)
Dimension drawing	

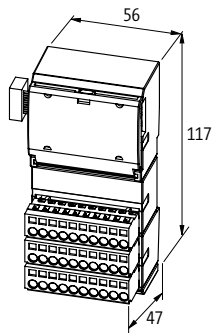

Notes

CUBE20

Analog inputs

– Temperature converter

Cube20 AI4 E RTD

Expansion module
for resistors and temperature



Cube20 AI4 E TH

Expansion module
for thermo elements



Approvals:  **UL** us
Listed

Order Data	Art-No.	Art-No.
AI4 - (E) RTD	56230	
AI4 - (E) TH		56240
Internal communication		
Module Supply	via system connection	
Current consumption	max. 25 mA from system, max. 70 mA externally (UI)	max. 25 mA from system, max. 45 mA externally (UI)
Connections		
Fieldbus	Ribbon cable connection	
Sensor-system/actuator supply	4 × Spring clamp plug-in terminals, max. 2.5 mm ² (max. 12 A)	
I/O ports	16 × Spring clamp plug-in terminals, max. 2.5 mm ²	12 × Spring clamp plug-in terminals, max. 2.5 mm ²
Input		
Conversion time (analog)	max. 600 ms (per channel)	max. 300 ms (per channel)
Type	Pt100, 200, 500; Ni100, 120, 200, 500, 1000, R 0...3000 Ohm	K, N, E, J, R
Resolution (analog)	15 Bit + sign	
Accuracy	0.7...1.4%	max. ±2%, cold junction compensation
Connection	2-wire input: +Rx, -Rx / 3-wire input: +Rx, RLx, -Rx	2-wire input; TH+x, TH-x
Diagnostic		
Communication status	via LED	
Diagnostic via LED	per module	
Diagnostic via BUS	per module and channel	
Monitoring - under voltage	yes	
Monitoring - no voltage	no	
Short circuit and overload	yes	
Wire break upper/lower limit overload	per channel via LED and BUS	
General data		
Protection	IP20	
Mounting method	DIN-rail mountable (EN 60715)	
Temperature range	0...+55 °C (storage temperature -20...+85 °C)	
Dimension drawing		

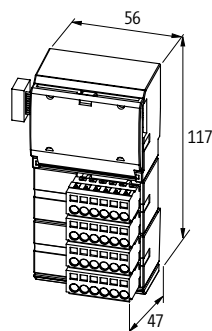

Notes

CUBE20

Analog outputs

– Voltage/current

Cube20 AO4 E

Expansion module
Voltage/current



Approvals:  Listed

Order Data		Art-No.
AO4 - (E) U/I		56220
Internal communication		
Module Supply	via system connection	
Current consumption	max. 25 mA from system, max. 90 mA externally (UI), idle load	
Connections		
Fieldbus	Ribbon cable connection	
Sensor-system/actuator supply	4 × Spring clamp plug-in terminals, max. 2.5 mm ² (max. 12 A)	
I/O ports	24 × Spring clamp plug-in terminals, max. 2.5 mm ²	
Output		
Conversion time (analog)	max. 1 ms (per channel)	
Resolution (analog)	15 Bit + sign	
Accuracy	max. 0.5%	
Galvanic isolation	500 V DC between inputs and internal communication	
Voltage output signals		
Load	min. 1 kOhm, (EN 61131-2)	
Input range	±10 V DC, 0...10 V DC	
Current outputs		
Load	max. 60 Ohm, (EN 61131-2)	
Input range	0...20 mA, 4...20 mA	
Diagnostic		
Communication status	via LED	
Diagnostic via LED	per module and channel	
Diagnostic via BUS	per module and channel	
Monitoring - under voltage	yes	
Monitoring - no voltage	no	
Short circuit and overload	yes	
Actuator warning	per channel via LED and BUS	
Wire break upper/lower limit overload	per channel via LED and BUS	
General data		
Protection	IP20	
Mounting method	DIN-rail mountable (EN 60715)	
Temperature range	0...+55 °C (storage temperature -20...+85 °C)	
Dimension drawing		

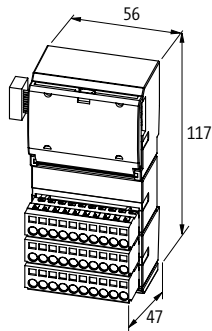

Notes

Connection accessories			Art-No.
	Bus Connection Plug 90° SUB-D9 (male), screw terminals	PROFIBUS	55762
	SUB-D9 (female), screw terminals	CANopen	55760
	Bus Connection Plug 180° SUB-D9 (male), IDC terminals, rigid cable	PROFIBUS	55584
	SUB-D9 (male), IDC terminals, flexible cable	PROFIBUS	55583
	Bus Connection Plug 90° SUB-D9 (male), IDC terminals, rigid cable	PROFIBUS	55585
	SUB-D9 (male), IDC terminals, flexible cable	PROFIBUS	55587
	Bus Connection Plug 90° SUB-D9 (male), IDC terminals, rigid cable, programming device conn.	PROFIBUS	55586
	SUB-D9 (male), IDC terminals, flexible cable, programming device conn.	PROFIBUS	55588
	Bus Connection Plug 90° SUB-D9 (male); M12 × 1, B-coded	PROFIBUS	7000-99441-0000000
Label-sheet Quantity: 40 pcs.			56113
	Potential terminal block gray/gray/brown/blue		56078
	gray/gray/yellow/blue		56079
	yellow/blue/yellow/blue		56080
	brown/blue/brown/blue		56081
	blue/yellow/brown/blue		56111
	gray/gray/gray/gray		56084
	blue/blue/blue/blue		56085
	brown/brown/brown/brown		56077
	brown/brown/blue/blue		56109
	blue/yellow		56110

CUBE20

Connection accessories

Art-No.



Potential terminal block

Multi color

56083



Potential terminal block

Slim Line

56082

Cube20



CUBE20S

SMALL, SPEEDY, SAFE

- Extremely modular
- Up to 64 modules per bus node
- Quick reaction time: up to 20 μ s

A MEMBER OF THE CUBE-FAMILY

Murrelektronik's modular Cube20S I/O system expands the field-tested Cube family with another product line that is extremely useful.

The compact modules are only 12.9 millimeters wide and have modular design, allowing them to be installed in series easily, quickly and according to individual requirements – the integrated backplane bus connects the modules to energy and data.

Bus nodes for Cube20S are available for standard fieldbus protocols.



Cube20S I/O Modules

 <p>Bus nodes/Power modules</p> <p><i>Page 4.3.1</i></p>	 <p>Supply module</p> <p><i>Page 4.3.4</i></p>
 <p>Digital inputs</p> <p><i>Page 4.3.6</i></p>	 <p>Digital outputs</p> <p><i>Page 4.3.8</i></p>
 <p>Analog inputs</p> <p><i>Page 4.3.11</i></p>	 <p>Analog outputs</p> <p><i>Page 4.3.13</i></p>
 <p>Safety modules</p> <ul style="list-style-type: none"> • Digital inputs • Digital outputs  <p><i>Page 4.3.7/4.3.10</i></p>	

CUBE20S

Bus Nodes

– Power module included



Approvals: UL Listed

Cube20S



Cube20S



Order Data	Art-No.	Art-No.
PROFIBUS DP	57101	
PROFINET IO		57106
Connections		
Fieldbus	PROFIBUS 12 Mbit/s; SUB-D9	Ethernet 10/100 Mbit/s; 2 × RJ45 (female)
Internal system connection	4 × Spring clamp plug-in terminals, max. 1.5 mm ² (max. 10 A)	
Sensor-system/actuator supply	4 × Spring clamp plug-in terminals, max. 1.5 mm ² (max. 10 A)	
Module supply		
Operating voltage	24 V DC (EN 61131-2)	
Current consumption	max. 95 mA	
PROFIBUS		
Addressing	Address switch 1...125	–
PROFINET		
Addressing	–	DCP
Shared Device/Input	–	yes, for 3 controls
Specification	–	V2.2, Conformance Class B
MRP	–	yes
Cube system		
Module capacity	max. 64	
I/O capacity	max. 244 Byte (Input), max. 244 Byte (Output)	max. 512 Byte (Input), max. 512 Byte (Output)
Machine Option Management	–	yes
Output		
Output voltage (I/Os /Backplane)	24 V DC/5 V DC	
Output current (I/Os /Backplane)	10 A/3 A	
Diagnostic		
Communication status	via LED	
Diagnostic via LED	per module and channel	
Diagnostic via BUS	per module	
Monitoring - under voltage	no	
Monitoring - no voltage	yes	
Short circuit and overload	yes	
Actuator warning	no	
General data		
Protection	IP20	
Connection	Spring clamp plug-in terminals: max. 1.5 mm ² (max. 10 A)	
Mounting method	DIN-rail mountable (EN 60715)	
Temperature range	0...+60 °C (storage temperature -25...+70 °C)	
Dimension drawing		

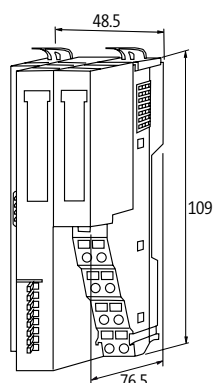

Cube20S

CUBE20S

Bus Nodes

– Power module included

EtherNet/IP EtherCAT

Cube20S



Approvals:  Listed

Order Data	Art-No.	Art-No.
EtherNet/IP	57105	
EtherCAT		57103
Connections		
Fieldbus	Ethernet 10/100 Mbit/s; 1 × RJ45 (female)	Ethernet 10/100 Mbit/s; 2 × RJ45 (female)
Internal system connection	4 × Spring clamp plug-in terminals, max. 1.5 mm ² (max. 10 A)	
Sensor-system/actuator supply	4 × Spring clamp plug-in terminals, max. 1.5 mm ² (max. 10 A)	
Module supply		
Operating voltage	24 V DC (EN 61131-2)	
Current consumption	max. 95 mA	
EtherNet/IP		
Addressing	DHCP, BOOTP or IP address by rotary switch	–
EtherCAT		
Addressing	–	automatic
Operating modes	–	FreeRun, SyncManager-Event, Distributed Clock, HotConnect
Cube system		
Module capacity	max. 64	
I/O capacity	max. 1024 Byte (Input), max. 1024 Byte (Output)	
Output		
Output voltage (I/Os /Backplane)	24 V DC/5 V DC	
Output current (I/Os /Backplane)	10 A/3 A	
Diagnostic		
Communication status	via LED	
Diagnostic via LED	per module and channel	
Diagnostic via BUS	per module	
Monitoring - under voltage	no	
Monitoring - no voltage	yes	
Short circuit and overload	yes	
Actuator warning	no	
General data		
Protection	IP20	
Connection	Spring clamp plug-in terminals: max. 1.5 mm ² (max. 10 A)	
Mounting method	DIN-rail mountable (EN 60715)	
Temperature range	0...+60 °C (storage temperature -25...+70 °C)	
Dimension drawing		

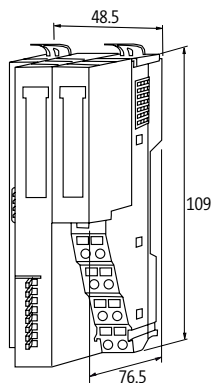

Notes

CUBE20S

Bus Nodes

– Power module included

CANopen 

Approvals: 

Cube20S



Cube20S



Order Data	Art-No.	Art-No.
CANopen	57104	
Modbus TCP		57108
Connections		
Fieldbus	CAN 1 Mbit/s; SUB-D9	Ethernet 10/100 Mbit/s; 1 × RJ45 (female)
Internal system connection	4 × Spring clamp plug-in terminals, max. 1.5 mm ² (max. 10 A)	
Sensor-system/actuator supply	4 × Spring clamp plug-in terminals, max. 1.5 mm ² (max. 10 A)	
Module supply		
Operating voltage	24 V DC (EN 61131-2)	
Current consumption	max. 95 mA	
CANopen		
Addressing	DIP switch	–
Modbus		
Addressing	–	Webserver
Cube system		
Module capacity	max. 64	
I/O capacity	max. 128 Byte (Input), max. 128 Byte (Output)	max. 1024 Byte (Input), max. 1024 Byte (Output)
Output		
Output voltage (I/Os / Backplane)	24 V DC/5 V DC	
Output current (I/Os / Backplane)	10 A/3 A	
Diagnostic		
Communication status	via LED	
Diagnostic via LED	per module and channel	
Diagnostic via BUS	per module	
Monitoring - under voltage	no	
Monitoring - no voltage	yes	
Short circuit and overload	yes	
Actuator warning	no	
General data		
Protection	IP20	
Connection	Spring clamp plug-in terminals: max. 1.5 mm ² (max. 10 A)	
Mounting method	DIN-rail mountable (EN 60715)	
Temperature range	0...+60 °C (storage temperature -25...+70 °C)	
Dimension drawing		

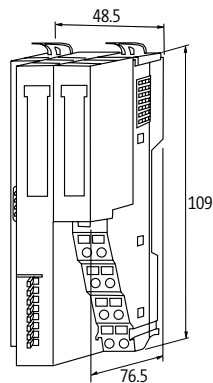

Notes

CUBE20S

Power supplies

Cube20S

Potential distributor



Approvals:  UL US
Listed

Cube20S

Order Data	Art-No.	Art-No.	Art-No.
8 × 24 V DC	57120		
8 × 0 V DC		57121	
4×24 + 4×0 V DC			57122
Module supply			
Operating voltage	max. 30 V DC	max. 0 V DC	max. 30 V DC
Total current	max. 10 A		
General data			
Protection	IP20		
Connection	Spring clamp terminals: 0.08...2.5 mm ² (AWG 28...14)		
Mounting method	DIN-rail mountable (EN 60715)		
Temperature range	0...+60 °C (storage temperature -25...+70 °C)		
Dimension drawing			

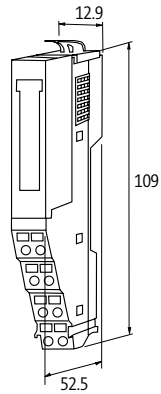

Notes

CUBE20S

Power supplies

Cube20S

for external voltage supply



Cube20S

for external voltage supply and internal backplane

Approvals:  **UL** us
Listed

Order Data	Art-No.	Art-No.
Power module	57130	57131
Module supply		
Operating voltage	max. 28.8 V DC	
Total current	max. 10 A	max. 6 A
Output		
Output current (I/Os /Backplane)	10/0 A	4 A/2 A
Output voltage (I/Os /Backplane)	24 V AC	24 V DC/5 V DC
General data		
Protection	IP20	
Connection	Spring clamp terminals: 0.08...2.5 mm ² (AWG 28...14)	
Mounting method	DIN-rail mountable (EN 60715)	
Temperature range	0...+60 °C (storage temperature -25...+70 °C)	
Dimension drawing		

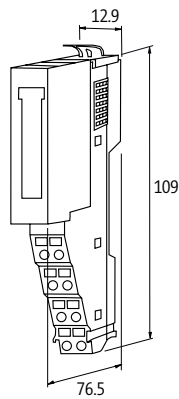

Notes

CUBE20S

Digital inputs

Cube20S



Approvals:  UL US
Listed

Cube20S

Order Data		Art-No.
DI2 - (E) NPN		57220
DI4 - (E)		57240
DI8 - (E)		57280
Internal communication		
Module supply	via system connection	
Current consumption	max. 55 mA	
Input		
Sensor supply US	24 V DC (EN 61131-2), max. 500 mA per module	
Type	PNP (EN 61131-2)	
Input filter	3 ms	
Galvanic isolation	500 V DC between inputs and internal communication	
Diagnostic		
Communication status	via LED	
Diagnostic via LED	per module and channel	
Diagnostic via BUS	per module	
Monitoring - under voltage	no	
Monitoring - no voltage	yes	
Short circuit and overload	yes	
General data		
Protection	IP20	
Connection	Spring clamp plug-in terminals: max. 1.5 mm ² (AWG 16)	
Mounting method	DIN-rail mountable (EN 60715)	
Temperature range	0...+60 °C (storage temperature -20...+70 °C)	
Dimension drawing		

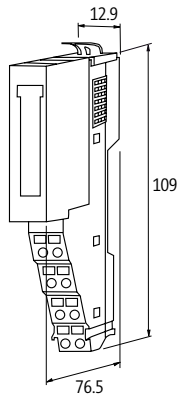

Notes

CUBE20S

Safe inputs (Safety)

– active safety



Approvals: UL_{us}
Listed

Cube20S FDI4/2



Order Data	Art-No.
FDI4/2 - (E)	57290
Internal communication	
Module supply	via system connection
Current consumption	max. 95 mA
Safety Indicators	
PL	up to e
Category	up to 4
PFH	0.25E-9
DC	high
SIL	up to 3
SIL CL	up to 3
Service life	20 years
Input	
Sensor supply US	24 V DC (EN 61131-2), max. 500 mA per module
Type	PNP (EN 61131-2)
Input filter	3 ms
Galvanic isolation	500 V DC between inputs and internal communication
Diagnostic	
Communication status	via LED
Diagnostic via LED	per module and channel
Diagnostic via BUS	per module and channel
Short circuit and overload	yes
General data	
Protection	IP20
Connection	Spring clamp plug-in terminals: max. 1.5 mm ² (AWG 16)
Mounting method	DIN-rail mountable (EN 60715)
Temperature range	0...+60 °C (storage temperature -20...+70 °C)
Dimension drawing	

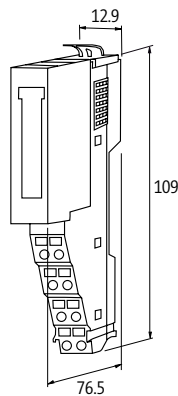

Notes

CUBE20S

Digital outputs

Cube20S



Approvals:  UL US
Listed

Cube20S

Order Data	Art-No.
DO2 - (E)	57320
DO4 - (E)	57340
DO8 - (E)	57380

Internal communication

Module supply	via system connection
Current consumption	max. 55 mA

Output

Actuator supply UA	24 V DC (EN 61131-2), max. 1 A
Switching current per output	max. 0.5 A (short-circuit and overload protected)
Galvanic isolation	500 V DC between outputs and internal communication
Lamp load	5 W
Output delay time	175 ns

Diagnostic

Communication status	via LED
Diagnostic via LED	per module and channel
Diagnostic via BUS	per module
Monitoring - under voltage	yes
Monitoring - no voltage	no
Short circuit and overload	yes

General data

Protection	IP20
Connection	Spring clamp plug-in terminals: max. 1.5 mm ² (AWG 16)
Mounting method	DIN-rail mountable (EN 60715)
Temperature range	0...+60 °C (storage temperature -25...+70 °C)

Dimension drawing

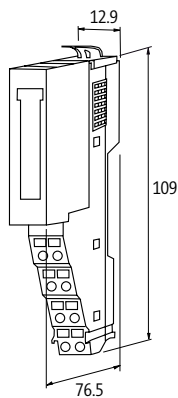

Notes

CUBE20S

Digital outputs

Cube20S - 2 A

Cube20S - 230 V AC (Relays)



Approvals:  UL[®] Listed

Order Data	Art-No.	Art-No.
DO2 - (E)	57325	57327
DO4 - (E)	57345	
Internal communication		
Module supply	via system connection	
Current consumption	max. 60 mA	max. 130 mA
Output		
Actuator supply UA	24 V DC (EN 61131-2), max. 4 A	max. 30 V DC/230 V AC
Switching current per output	max. 2 A (short-circuit and overload protected)	max. 3 A (short-circuit and overload protected)
Galvanic isolation	500 V DC between outputs and internal communication	
Lamp load	10 W	–
Diagnostic		
Communication status	via LED	
Diagnostic via LED	per module and channel	
Diagnostic via BUS	per module	
Monitoring - under voltage	yes	
Monitoring - no voltage	no	
Short circuit and overload	yes	
General data		
Protection	IP20	
Connection	Spring clamp plug-in terminals: max. 1.5 mm ² (AWG 16)	
Mounting method	DIN-rail mountable (EN 60715)	
Temperature range	0...+60 °C (storage temperature -25...+70 °C)	

Dimension drawing

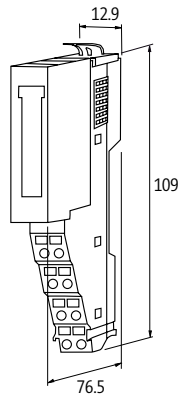

Notes

CUBE20S

Safe outputs (Safety)

– active safety



Approvals: UL US
Listed

Cube20S FDO4/2



Cube20S

Order Data		Art-No.
FDO4/2 - (E)		57390
Internal communication		
Module supply	via system connection	
Current consumption	max. 75 mA	
Safety Indicators		
PL	up to e	
Category	up to 4	
PFH	0.22E-9	
DC	high	
SIL	up to 3	
SIL CL	up to 3	
Service life	20 years	
Output		
Actuator supply UA	24 V DC (EN 61131-2), max. 2 A	
Switching current per output	max. 0.5 A (short-circuit and overload protected)	
Galvanic isolation	500 V DC between outputs and internal communication	
Lamp load	5 W	
Output delay time	175 µs	
Diagnostic		
Communication status	via LED	
Diagnostic via LED	per module and channel	
Diagnostic via BUS	per module and channel	
Short circuit and overload	yes	
General data		
Protection	IP20	
Connection	Spring clamp plug-in terminals: max. 1.5 mm ² (AWG 16)	
Mounting method	DIN-rail mountable (EN 60715)	
Temperature range	0...+60 °C (storage temperature -25...+70 °C)	
Dimension drawing		

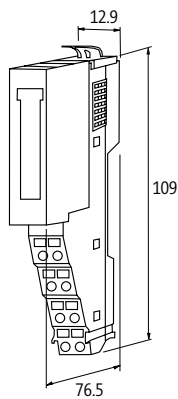

Notes

Analog inputs

Cube20S

Voltage



Cube20S

Current

Cube20S

Voltage

Approvals:  Listed

Order Data	Art-No.	Art-No.	Art-No.
AI2 - (E)	57231	57232	57233
AI4 - (E)	57261	57262	57263
Internal communication			
Module supply	via system connection		
Current consumption	max. 60 mA from system, max. 25 mA externally (UI)	max. 60 mA from system, max. 15 mA externally (UI)	max. 60 mA from system, max. 25 mA externally (UI)
Input			
Conversion time (analog)	240 µs (all channels)		
Resolution (analog)	15 Bit + sign		
Accuracy	max. ±0.2%	max. 0.3%	max. ±0.2%
Connection	Differential voltage input	Differential current input	Differential voltage input
Voltage inputs			
Input resistor	200 kOhm	–	200 kOhm
Input range	0...10 V	–	-10 V DC...+10 V DC
Current input signals			
Load	–	max. 60 Ohm, (EN 61131-2)	–
Input range	–	0...20 mA, 4...20 mA	–
Diagnostic			
Communication status	via LED		
Diagnostic via LED	per module and channel		
Diagnostic via BUS	per module		
Monitoring - under voltage	yes		
Monitoring - no voltage	no		
Short circuit and overload	yes		
Wire break upper/lower limit overload	per module via LED and BUS		
General data			
Protection	IP20		
Connection	Spring clamp plug-in terminals: max. 1.5 mm ² (AWG 16)		
Mounting method	DIN-rail mountable (EN 60715)		
Temperature range	0...+60 °C (storage temperature -25...+70 °C)		
Dimension drawing			

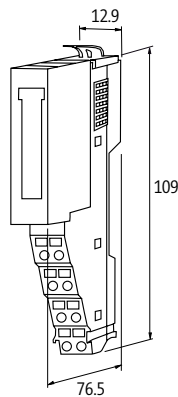

Notes

CUBE20S

Analog inputs

Cube20S (TH)

for thermo elements

Cube20S (RTD)

for resistors and temperature



Approvals:  Listed

Cube20S

Order Data	Art-No.	Art-No.
AI2 - (E)	57230	
AI4 - (E)		57265
Internal communication		
Module supply	via system connection	
Current consumption	max. 75 mA from the system, max. 30 mA externally (UI)	max. 75 mA
Input		
Conversion time (analog)	max. 4.2...324.1 ms, 50 Hz (per channel)	
Type	B, C, E, J, K, L, N, R, S, T	Pt100, Pt1000, Ni100, Ni1000, R 0...3000 Ohm
Resolution (analog)	15 Bit + sign	
Accuracy	max. ±0.3%, cold junction compensation	0.7...1.4%
Connection	2-wire input; TH+x, TH-x	2-wire (4 input); 3-, 4-wire (2 input)
Diagnostic		
Communication status	via LED	
Diagnostic via LED	per module and channel	
Diagnostic via BUS	per module	
Monitoring - under voltage	yes	
Monitoring - no voltage	no	
Short circuit and overload	yes	
Wire break upper/lower limit overload	per channel via LED and BUS	
General data		
Protection	IP20	
Connection	Spring clamp plug-in terminals: max. 1.5 mm ² (AWG 16)	
Mounting method	DIN-rail mountable (EN 60715)	
Temperature range	0...+55 °C (storage temperature -20...+85 °C)	0...+60 °C (storage temperature -25...+70 °C)
Dimension drawing		

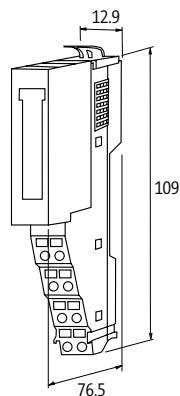

Notes

CUBE20S

Analog outputs

Cube20S

Voltage



Approvals:  UL Listed



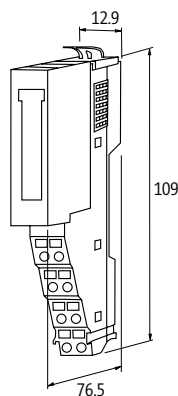



Order Data	Art-No.	Art-No.	Art-No.	Art-No.
AO2 - (E)	57331		57333	
AO4 - (E)		57361		57363
Internal communication				
Module supply	via system connection			
Current consumption	max. 60 mA from system, max. 25 mA externally (UI), idle load			
Output				
Conversion time (analog)	200 µs (all channels)			
Resolution (analog)	15 Bit + sign			
Accuracy	max. 0.5%		max. 0.2%	
Galvanic isolation	500 V DC between inputs and internal communication			
Voltage output signals				
Load	5 kOhm			
Input range	0...10 V		-10 V DC...+10 V DC	
Diagnostic				
Communication status	via LED			
Diagnostic via LED	per module and channel			
Diagnostic via BUS	per module			
Monitoring - under voltage	yes			
Monitoring - no voltage	no			
Short circuit and overload	yes			
Actuator warning	per module via LED and BUS			
Wire break upper/lower limit overload	per module via LED and BUS			
General data				
Protection	IP20			
Connection	Spring clamp plug-in terminals: max. 1.5 mm ² (AWG 16)			
Mounting method	DIN-rail mountable (EN 60715)			
Temperature range	0...+60 °C (storage temperature -25...+70 °C)			
Dimension drawing				



Notes

Cube20S

CUBE20S

Connection accessories			Art-No.
	Bus cover Black plastic		57190
	Shield bus carrier Black plastic	Quantity: 10 pcs.	57191
	Bus connection plug 90° SUB-D9 (male), screw terminals	PROFIBUS	55762
	SUB-D9 (female), screw terminals	CANopen	55760
	Bus connection plug 180° SUB-D9 (male), IDC terminals, rigid cable	PROFIBUS	55584
	SUB-D9 (male), IDC terminals, flexible cable	PROFIBUS	55583
	Bus connection plug 90° SUB-D9 (male), IDC terminals, rigid cable	PROFIBUS	55585
	SUB-D9 (male), IDC terminals, flexible cable	PROFIBUS	55587
	Bus connection plug 90° SUB-D9 (male), IDC terminals, rigid cable, programming device conn.	PROFIBUS	55586
	SUB-D9 (male), IDC terminals, flexible cable, programming device conn.	PROFIBUS	55588
	Bus connection plug 90° SUB-D9 (male); M12 × 1, B-coded	PROFIBUS	7000-99441-000000



MVK METAL COMPACT I/O MODULES FOR DEMANDING REQUIREMENTS

- Tough and reliable
- Safe (safety circuits according to EN 13849-1 up to PL_e)
- PROFINET – versions compliant with AIDA

MAXIMUM FLEXIBILITY

MVK Metal features a robust metal housing and is extremely resistant to vibration, media, and weld splatter.

- Double valves occupy only one M12 port
- PROFINET versions with Fast Start Up (< 500 ms)
- Models with multi-functional I/Os
- Fewer variations required, minimizes inventory costs
- Maximum flexibility for expansions

DON'T LOOK FOR ERRORS, FIND THEM

MVK Metal's diagnostic options offer detailed information about the type and location of the failure or the error.

- Only the affected port shuts down, not the whole module
- Detailed message sent to controls and device LED
- Minimizes downtime – failures are fixed faster

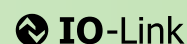

MVK Metal I/O Modules

 <p>MVK-MP</p> <ul style="list-style-type: none"> • Multifunctional I/Os • Digital I/Os • Safety outputs • Analog I/Os  <p>Page 4.4.1</p>	 <p>MVK-MPNIO</p> <ul style="list-style-type: none"> • Multifunctional I/Os • Digital I/Os • Push Pull • IO-Link • Safety inputs/outputs    <p>Page 4.4.6</p>
 <p>MVK-ME</p> <ul style="list-style-type: none"> • Multifunctional I/Os • IO-Link   <p>Page 4.4.14</p>	 <p>MIRO BT</p> <ul style="list-style-type: none"> • Bluetooth Master/Slave  <p>Page 4.4.16</p>

MVK METAL

Expanded diagnostic

- 7/8"



Approvals: UL
Listed

MVK-MP



Order Data	Art-No.	Art-No.	Art-No.
D18 (D18)	55307		
DIO8 (D18)		55308	
DIO8 (DIO8)			55309
Connections			
Fieldbus	PROFIBUS 12 Mbit/s; M12, B-coded		
Sensor-system/actuator supply	7/8", 5-pole, 2 x max. 9 A		
I/O ports	M12, 5-pole, A-coded		
PROFIBUS			
Addressing	Rotary switch 1...99		
Input			
Sensor supply US	24 V DC (EN 61131-2), max. 200 mA (M12 female), short-circuit and overload protected		
Type	for 3-wire sensors or mechanical switches, PNP		
Output			
Actuator supply UA	-	24 V DC (EN 61131-2), max. 9 A	
Switching current per output	-	max. 1.6 A (short-circuit and overload protected)	
Lamp load	-	10 W	
Parameterization			
PIN 4	Input	Input/Output	
PIN 2	Input/Diagnostic	Input/Output/Diagnostic	
General data			
Protection	IP67		
Mounting method	2-hole screw mounting		
Temperature range	-25...+55 °C (storage temperature -25...+70 °C)		
Dimension drawing			

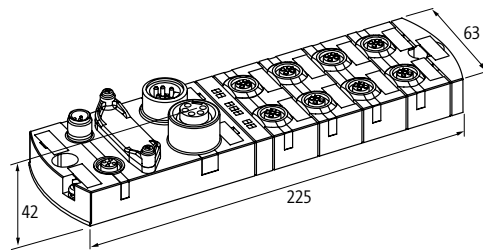

Notes

MVK METAL

Expanded diagnostic

- 7/8"



MVK-MP



Order Data	Art-No.	Art-No.
DO8 (DO8)	55290	
DO4 (DO4) DI4 (DI4)		55274
Connections		
Fieldbus	PROFIBUS 12 Mbit/s; M12, B-coded	
Sensor-system/actuator supply	7/8", 5-pole, 2 x max. 9 A	
I/O ports	M12, 5-pole, A-coded	
PROFIBUS		
Addressing	Rotary switch 1...99	
Input		
Sensor supply US	-	24 V DC (EN 61131-2), max. 200 mA (M12 female), short-circuit and overload protected
Type	-	for 3-wire sensors or mechanical switches, PNP
Output		
Actuator supply UA	24 V DC (EN 61131-2), max. 9 A	
Switching current per output	max. 1.6 A (short-circuit and overload protected)	
Lamp load	10 W	
General data		
Protection	IP67	
Mounting method	2-hole screw mounting	
Temperature range	-25...+55 °C (storage temperature -25...+70 °C)	
Dimension drawing		

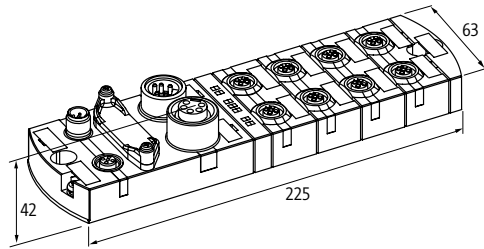

Notes

MVK METAL

Expanded diagnostic

- passive safety
- Output groups up to PLd (EN ISO 13849-1) can be switched off via safety relays

PROFIBUS

Approvals:  UL US Listed

MVK-MP Safety



Order Data	Art-No.
K3 DO4 (DO4) DIO4 (DIO4)	55291
Connections	
Fieldbus	PROFIBUS 12 Mbit/s; M12, B-coded
I/O ports	M12, 5-pole, A-coded
Sensor-system/actuator supply	7/8", 5-pole, max. 9 A, safe circuits (1 + 2) via separate 7/8" supply (yellow), 2-pole disconnectable
PROFIBUS	
Addressing	Rotary switch 1...99
Input	
Sensor supply US	24 V DC (EN 61131-2), max. 200 mA (M12 female), short-circuit and overload protected
Type	for 3-wire sensors or mechanical switches, PNP
Output	
Actuator supply UA	24 V DC (EN 61131-2), 3 circuits, (max. 9 A)
Switching current per output	max. 1.6 A (short-circuit and overload protected)
Lamp load	10 W
Safe output	
Switching current by safe output	max. 2 A short-circuit and overload protected, (EN13849-1) PLd
M12-(yellow) PIN 4	2 safety circuits (UA1/UA2) with 2 digital outputs each (EN13849-1) PLd
M12-(yellow) PIN 2	2 safety circuits (UA1/UA2) with 2 digital outputs each (EN13849-1) PLd
Parameterization	
PIN 4	4 × input/output
PIN 2	4 × Input/Output/Diagnostic
General data	
Protection	IP67
Mounting method	2-hole screw mounting
Temperature range	0...+55 °C (storage temperature -20...+70 °C)
Dimension drawing	

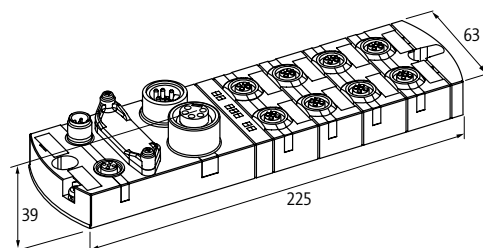

Notes

MVK METAL

Expanded diagnostic

– Analog outputs

– Current



Approvals: Listed

MVK-MP



Order Data	Art-No.
AO4 (I) DIO4 (DIO4)	55292
Connections	
Fieldbus	PROFIBUS 12 Mbit/s; M12, B-coded
Sensor-system/actuator supply	7/8", 5-pole, 2 × max. 9 A
I/O ports	M12, 5-pole, A-coded
PROFIBUS	
Addressing	Rotary switch 1...99
Input	
Sensor supply US	24 V DC (EN 61131-2), max. 200 mA (M12 female), short-circuit and overload protected
Type	for 3-wire sensors or mechanical switches, PNP
Output	
Actuator supply UA	24 V DC (EN 61131-2), max. 9 A
Switching current per output	max. 1.6 A (short-circuit and overload protected)
Lamp load	10 W
Input range (analog)	0...20 mA, 4...20 mA (0...10 V via adapter Art.-No. 7000-42252-0000000)
Conversion time (analog)	1 ms
General data	
Protection	IP67
Mounting method	2-hole screw mounting
Temperature range	0...+55 °C (storage temperature -20...+70 °C)
Dimension drawing	

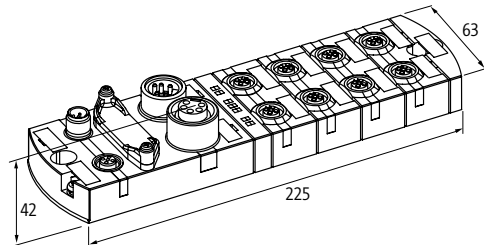

Notes

MVK METAL

Expanded diagnostic

– Analog inputs

– Voltage



Approvals: UL Listed

MVK-MP



Order Data	Art-No.
AI4 (U) DIO4 (DIO4)	55293
Connections	
Fieldbus	PROFIBUS 12 Mbit/s; M12, B-coded
Sensor-system/actuator supply	7/8", 5-pole, 2 × max. 9 A
I/O ports	M12, 5-pole, A-coded
PROFIBUS	
Addressing	Rotary switch 1...99
Input	
Sensor supply US	24 V DC (EN 61131-2), max. 200 mA (M12 female), short-circuit and overload protected
Type	for 3-wire sensors or mechanical switches, PNP
Resolution (analog)	16 Bit
Input range (analog)	0...10 V, (0...20 mA and 4...20 mA via adapter Art.-No. 7000-42251-0000000)
Input resistor (analog)	approx. 1 MOhm, differential input
Conversion time (analog)	1 ms
Output	
Actuator supply UA	24 V DC (EN 61131-2), max. 9 A
Lamp load (8×M12 left)	max. 1.6 A (short-circuit and overload protected)
Lamp load	10 W
General data	
Protection	IP67
Mounting method	2-hole screw mounting
Temperature range	0...+55 °C (storage temperature -20...+70 °C)
Dimension drawing	

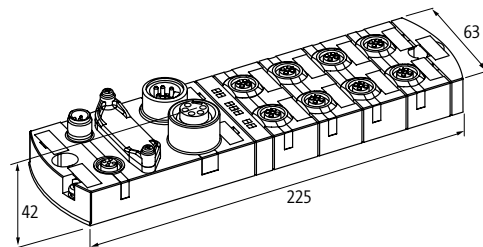

Notes

MVK METAL

Galvanic isolation K3

– POF Push Pull



MVK+ MPNIO POF



Order Data	Art-No.	Art-No.
D18 D18 IRT	55254	
D18 DO8 IRT		55255
Connections		
Fieldbus	Ethernet 10/100 Mbit/s; 2 × SCRJ45 POF-Push Pull	
Sensor-system/actuator supply	Power plug, Push Pull, max. 12 A	
I/O ports	M12, 5-pole, A-coded	
PROFINET		
FSU (Fast-Start-Up)	max. 500 ms	
Shared Device/Input	yes, for 2 controls	
Profinet Netload Class	III	
Specification	V2.2, Conformance Class C (IRT)	
MRP	yes	
Addressing	DCP	
Input		
Sensor supply US	24 V DC (EN 61131-2), max. 200 mA (M12 female), short-circuit and overload protected	
Type	for 3-wire sensors or mechanical switches, PNP	
Output		
Actuator supply UA	–	24 V DC (EN 61131-2), max. 12 A
Switching current per output	–	max. 2 A (short-circuit and overload protected)
Lamp load	–	10 W
Parameterization		
PIN 4	Input	Input (port 4...7); Output (port 0...3)
PIN 2	Input	Input (port 4...7); Output (port 0...3)
General data		
Protection	IP67	
Mounting method	2-hole screw mounting	
Temperature range	0...+55 °C (storage temperature -20...+70 °C)	
Dimension drawing		

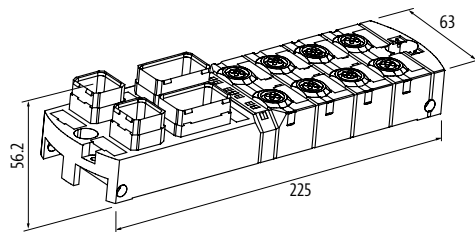

Notes

MVK METAL

Galvanic isolation K3

– Push Pull



MVK+ MPNIO



Order Data	Art-No.	Art-No.
DI8 DI8 IRT	55528	
DI8 DO8 IRT		55529
Connections		
Fieldbus	Ethernet 10/100 Mbit/s; Push Pull RJ45 Data connector	
Sensor-system/actuator supply	Power plug, Push Pull, max. 12 A	
I/O ports	M12, 5-pole, A-coded	
PROFINET		
FSU (Fast-Start-Up)	max. 500 ms	
Shared Device/Input	yes, for 2 controls	
Profinet Netload Class	III	
Specification	V2.2, Conformance Class C (IRT)	
MRP	yes	
Addressing	DCP	
Input		
Sensor supply US	24 V DC (EN 61131-2), max. 200 mA (M12 female), short-circuit and overload protected	
Type	for 3-wire sensors or mechanical switches, PNP	
Output		
Actuator supply UA	–	24 V DC (EN 61131-2), max. 12 A
Switching current per output	–	max. 2 A (short-circuit and overload protected)
Lamp load	–	10 W
Parameterization		
PIN 4	Input	Input (port 4...7); Output (port 0...3)
PIN 2	Input	Input (port 4...7); Output (port 0...3)
General data		
Protection	IP67	
Mounting method	2-hole screw mounting	
Temperature range	0...+55 °C (storage temperature -20...+70 °C)	
Dimension drawing		

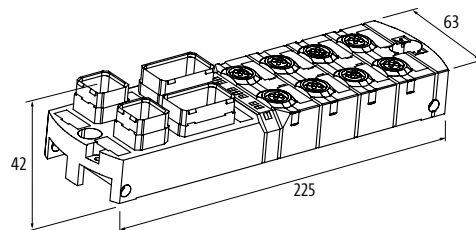

Notes

MVK METAL

Galvanic isolation K3

– Push Pull



MVK+ MPNIO



Order Data	Art-No.
DIO8 (DIO8)	55283
Connections	
Fieldbus	Ethernet 10/100 Mbit/s; Push Pull RJ45 Data connector
Sensor-system/actuator supply	Power plug, Push Pull, max. 12 A
I/O ports	M12, 5-pole, A-coded
PROFINET	
Specification	V2.2, Conformance Class B
MRP	yes
Addressing	DCP
Input	
Sensor supply US	24 V DC (EN 61131-2), max. 200 mA (M12 female), short-circuit and overload protected
Type	for 3-wire sensors or mechanical switches, PNP
Output	
Actuator supply UA	24 V DC (EN 61131-2), max. 12 A
Switching current per output	max. 1.6 A (short-circuit and overload protected)
Lamp load	10 W
Parameterization	
PIN 4	Input/Output
PIN 2	Input/Output/Diagnostic
General data	
Protection	IP67
Mounting method	2-hole screw mounting
Temperature range	0...+55 °C (storage temperature -20...+70 °C)
Dimension drawing	

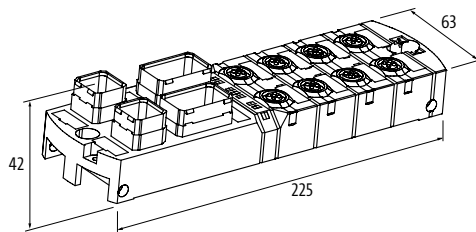

Notes

MVK METAL

Galvanic isolation K3

– FSU (Fast-Start-Up)

– 7/8"



Approvals: UL_{us}
Listed

MVK+ MPNIO



Order Data	Art-No.
DO8 (DI4 DI4)	55339
Connections	
Fieldbus	Ethernet 10/100 Mbit/s; M12, D-coded
Sensor-system/actuator supply	7/8", 5-pole, max. 9 A, protection against reverse polarization
I/O ports	M12, 5-pole, A-coded
PROFINET	
FSU (Fast-Start-Up)	max. 500 ms
Specification	V2.2, Conformance Class B
MRP	yes
Addressing	DCP
Input	
Sensor supply US	24 V DC (EN 61131-2), max. 200 mA (M12 female), short-circuit and overload protected
Type	for 3-wire sensors or mechanical switches, PNP
Output	
Actuator supply UA	24 V DC (EN 61131-2), max. 9 A
Switching current per output	max. 2 A (short-circuit and overload protected)
Lamp load	10 W
Parameterization	
PIN 4	Input (port 4...7); Output (port 0...3)
PIN 2	Input (port 4...7); Output (port 0...3)
General data	
Protection	IP67
Mounting method	2-hole screw mounting
Temperature range	-25...+55 °C (storage temperature -25...+70 °C)
Dimension drawing	

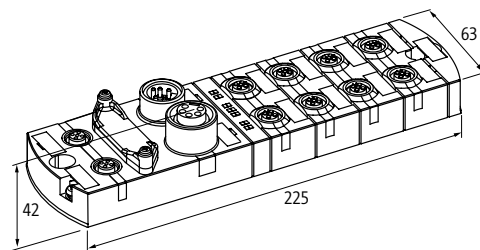

Notes

MVK METAL

FSU (Fast-Start-Up)

- 7/8"



MVK-MPNIO



Order Data	Art-No.
DIO16 IRT	55530
Connections	
Fieldbus	Ethernet 10/100 Mbit/s; M12, D-coded
Sensor-system/actuator supply	7/8", 5-pole, 2 × max. 9 A
I/O ports	M12, 5-pole, A-coded
PROFINET	
FSU (Fast-Start-Up)	max. 500 ms
Shared Device/Input	yes, for 2 controls
Profinet Netload Class	III
Specification	V2.3, Conformance Class C (IRT)
MRP	yes
Addressing	DCP
Input	
Sensor supply US	24 V DC (EN 61131-2), max. 200 mA (M12 female), short-circuit and overload protected
Type	for 3-wire sensors or mechanical switches, PNP
Output	
Actuator supply UA	24 V DC (EN 61131-2), max. 9 A
Switching current per output	max. 1.6 A (short-circuit and overload protected)
Lamp load	10 W
Parameterization	
PIN 4	Input/Output (port X0...X7)
PIN 2	Input/Output (port X0...X7)
General data	
Protection	IP67
Mounting method	2-hole screw mounting
Temperature range	-25...+60 °C (storage temperature -25...+70 °C)
Dimension drawing	

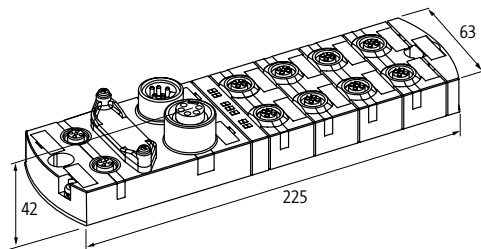

Notes

MVK METAL

FSU (Fast-Start-Up)

- 7/8"



MVK-MPNIO IO-Link



MVK-MPNIO IO-Link



Order Data	Art-No.	Art-No.
DIO14 IOL2 IRT	55531	
DIO12 IOL4 IRT		55532
Connections		
Fieldbus	Ethernet 10/100 Mbit/s; M12, D-coded	
Sensor-system/actuator supply	7/8", 5-pole, 2 × max. 9 A	
I/O ports	M12, 5-pole, A-coded	
PROFINET		
FSU (Fast-Start-Up)	max. 500 ms	
Shared Device/Input	yes, for 2 controls	
Profinet Netload Class	III	
Specification	V2.3, Conformance Class C (IRT)	
MRP	yes	
Addressing	DCP	
IO-Link		
IO-Link	2 × Master	4 × Master
Operating modes	COM1; COM2; COM3 (automatic)	
Transfer parameters	32 Byte (via IO-Link Port)	
Port class	Class B (not galvanically separated)	Class A + B (not galvanically separated)
Specification	IO-Link Master V1.12	
Input		
Sensor supply US	24 V DC (EN 61131-2), max. 200 mA (M12 female), short-circuit and overload protected	
Type	for 3-wire sensors or mechanical switches, PNP, IO-Link Devices	
Output		
Actuator supply UA	24 V DC (EN 61131-2), max. 9 A	
Switching current per output	max. 1.6 A (short-circuit and overload protected)	
Lamp load	10 W	
Parameterization		
PIN 4	Input (port X0...X7); Output (port X0...X5); IO-Link Master (port X6, X7)	Input (port X0...X7); Output (port X0...X3); IO-Link Master (port X4...X7)
PIN 2	Input/Output (port X0...X7); U-Actuator IO-Link Class B (port X6, X7)	
General data		
Protection	IP67	
Mounting method	2-hole screw mounting	
Temperature range	-25...+60 °C (storage temperature -25...+70 °C)	
Dimension drawing		

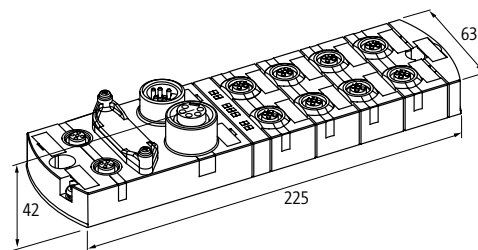

Notes

MVK Metal

MVK METAL

Active safety

- safe inputs/outputs up to cat.4/PLe (EN ISO 13849-1), up to SIL3 (IEC 61508), up to SILCL3 (IEC 62061)



Approvals: Listed

MVK-MPNIO Safety

Push Pull



Order Data	Art-No.	Art-No.
DI16/8 F	55562	
DI8/4 F DO4		55563
Safety Indicators		
PL	up to e	
Category	up to 4	
PFH	1.70E-9	1.653E-9
DC	98%	
SIL	up to 3	
SIL CL	up to 3	
Service life	20 years	
Connections		
Fieldbus	Ethernet 10/100 Mbit/s; Push Pull RJ45 Data connector	
Sensor-system/actuator supply	Power plug, Push Pull, max. 12 A	
I/O ports	M12, 5-pole, A-coded	
PROFINET		
Shared Device/Input	yes, for 2 controls	
Specification	V2.2, Conformance Class C (IRT)	
MRP	yes	
Addressing	DCP	
Safety input		
Sensor supply US	24 V DC (EN 61131-2), max. 200 mA (PIN 1+5), short-circuit and overload protected, or max. 700 mA for only one PIN	
Type	for electrical sensors or mechanical switches	
Safe output		
Actuator supply UA	–	24 V DC (EN 61131-2), max. 9 A
Switching current by safe output	–	max. 2 A (short-circuit and overload protected)
General data		
Protection	IP67	
Mounting method	2-hole screw mounting	
Temperature range	-20...+55 °C (storage temperature -40...+70 °C)	
Dimension drawing		

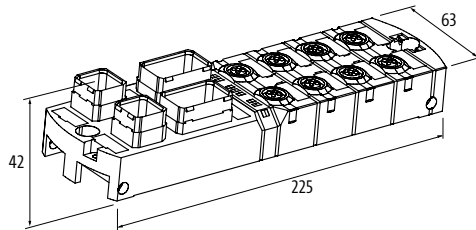

Notes

MVK METAL

Active safety

- safe inputs/outputs up to cat.4/PLe (EN ISO 13849-1), up to SIL3 (IEC 61508), up to SILCL3 (IEC 62061)



Approvals: UL_{us} Listed

MVK-MPNIO Safety

7/8"



Order Data	Art-No.	Art-No.
DI16/8 F IRT	55556	
DI8/4 F DO4 IRT		55557
Safety Indicators		
PL	up to e	
Category	up to 4	
PFH	1.70E-9	1.653E-9
DC	98%	
SIL	up to 3	
SIL CL	up to 3	
Service life	20 years	
Connections		
Fieldbus	Ethernet 10/100 Mbit/s; M12, D-coded	
Sensor-system/actuator supply	7/8", 5-pole, 2 × max. 9 A	
I/O ports	M12, 5-pole, A-coded	
PROFINET		
Shared Device/Input	yes, for 2 controls	
Specification	V2.2, Conformance Class C (IRT)	
MRP	yes	
Addressing	DCP	
Safety input		
Sensor supply US	24 V DC (EN 61131-2), max. 200 mA (PIN 1+5), short-circuit and overload protected, or max. 700 mA for only one PIN	
Type	for electronic sensors or mechanical switches	
Safe output		
Actuator supply UA	–	24 V DC (EN 61131-2), max. 9 A
Switching current by safe output	–	max. 2 A (short-circuit and overload protected)
General data		
Protection	IP67	
Mounting method	2-hole screw mounting	
Temperature range	-20...+55 °C (storage temperature -40...+70 °C)	
Dimension drawing		

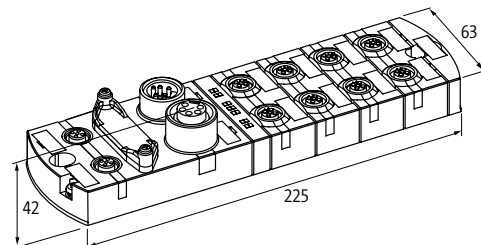

Notes

MVK METAL

Expanded diagnostic

– 7/8"

EtherNet/IP

Approvals:  

MVK-ME

DIO8 (DIO8)
DLR (Device Level Ring)

MVK-ME

DIO16
DLR (Device Level Ring)



Order Data	Art-No.	Art-No.
DIO8 (DIO8)	55099	
DIO16		55542
Connections		
Fieldbus	Ethernet 10/100 Mbit/s; M12, D-coded	
Sensor-system/actuator supply	7/8", 5-pole, 2 × max. 9 A	7/8", 4-pole, 2 × max. 9 A
I/O ports	M12, 5-pole, A-coded	
EtherNet/IP		
Addressing	DHCP, BOOTP or IP address by rotary switch	DHCP, BOOTP or IP address by DIP switch
DLR (Device Level Ring)	yes	
QC (Quick Connect)	–	max. 360 ms
Multiple connections	–	yes
CIP Sync	–	yes
Composite Test Revision	–	CT14
Input		
Sensor supply US	24 V DC (EN 61131-2), max. 200 mA (M12 female), short-circuit and overload protected	
Type	for 3-wire sensors or mechanical switches, PNP	
Output		
Actuator supply UA	24 V DC (EN 61131-2), max. 9 A	
Switching current per output	max. 1.6 A (short-circuit and overload protected)	
Lamp load	10 W	
Parameterization		
PIN 4	Input/Output (port X0...X7)	
PIN 2	Input/Output (port X0...X7)	
General data		
Protection	IP67	
Mounting method	2 hole screw mounting, compatible with I/O modules of MVK model range	2-hole screw mounting
Temperature range	-25...+55 °C (storage temperature -25...+70 °C)	-25...+60 °C (storage temperature -40...+85 °C)
Dimension drawing		

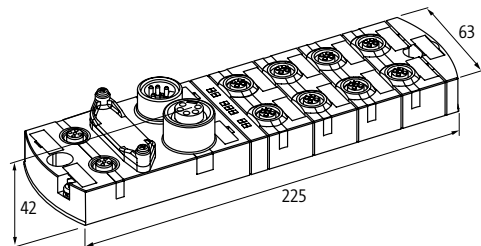

Notes

MVK METAL

Expanded diagnostic

- 7/8"

EtherNet/IP IO-Link

Approvals:

MVK-ME IO-Link

DIO14 IOL2
DLR (Device Level Ring)

MVK-ME IO-Link

DIO12 IOL4
DLR (Device Level Ring)



Order Data	Art-No.	Art-No.
DIO14 IOL2	55543	
DIO12 IOL4		55544
Connections		
Fieldbus	Ethernet 10/100 Mbit/s; M12, D-coded	
Sensor-system/actuator supply	7/8", 4-pole, 2 × max. 9 A	
I/O ports	M12, 5-pole, A-coded	
EtherNet/IP		
Addressing	DHCP, BOOTP or IP address by DIP switch	
QC (Quick Connect)	max. 360 ms	
Multiple connections	yes	
CIP Sync	yes	
Composite Test Revision	CT14	
DLR (Device Level Ring)	yes	
IO-Link		
IO-Link	2 × Master	4 × Master
Operating modes	COM1; COM2; COM3 (automatic)	
Transfer parameters	32 Byte (via IO-Link Port)	
Port class	Class B (not galvanically separated)	
Specification	IO-Link Master V1.12	
Input		
Sensor supply US	24 V DC (EN 61131-2), max. 200 mA (M12 female), short-circuit and overload protected	
Type	for 3-wire sensors or mechanical switches, PNP, IO-Link Devices	
Output		
Actuator supply UA	24 V DC (EN 61131-2), max. 9 A	
Switching current per output	max. 1.6 A (short-circuit and overload protected)	
Lamp load	10 W	
Parameterization		
PIN 4	Input/Output (port X0...X7); IO-Link Master (port X6, X7)	Input/Output (port X0...X7); IO-Link Master (port X4...X7)
PIN 2	Input/Output (port X0...X7); U-Actuator IO-Link Class B (port X6, X7)	Input/Output (port X0...X7); U-Actuator IO-Link Class B (port X4...X7)
General data		
Protection	IP67	
Mounting method	2-hole screw mounting	
Temperature range	-25...+55 °C (storage temperature -40...+85 °C)	
Dimension drawing		

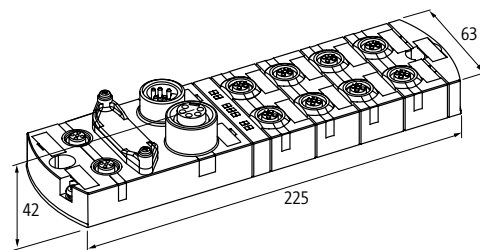

Notes

MVK METAL

Accessories for MVK PROFINET

– Wireless transmission



MIRO BT





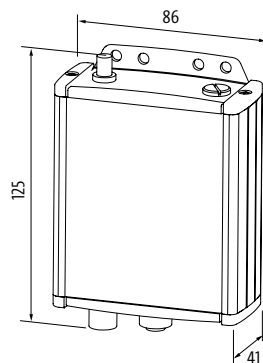

Bluetooth Master/Slave
PROFINET



Order Data		Art-No.
Master/Slave		57018
Connections		
Fieldbus	Ethernet 10/100Mbit/s; M12, D-coded	
Supply	M12, 5-pole, A-coded	
Technical Data		
Operating voltage	24 V DC (EN 61131-2)	
Operating current	max. 150 mA	
Wireless technology		
Frequency	2.4 GHz Bluetooth	
Transmission power	100 mW	
No. of wireless slaves/devices	max. 4/max. 6	
Coverage indoor	100 m	
Coverage outdoor	300 m	
Antenna connection	SMA (50 Ohm)	
General data		
Standards	approved in: BE, DK, DE, EE, FI, FR (restricted), GR, GB, IE, IS, IT, CA, LV, LT, LU, MT, NL, NO (without Spitzbergen), AT, PL, PT, SE, CH, SK, SI, ES, CZ, HU, US, CY	
Housing	Metal black	
Protection	IP65	
Mounting method	screw fixing, M4	
Temperature range	-20...+60 °C (storage temperature -40...+75 °C)	
Dimension drawing		



Notes

Blind Plug/caps		Art-No.
	Screw plug M12 x 1 mm Metal, hex, 1 piece	996049
	Blind cap 7/8" Metal	55390
	Blind plug diagnostic M12 x 1 mm Bridge PIN 1 and PIN 2	7000-13481-0000000
	Addressing cap Metal	55317
Labeling accessories		Art-No.
	Label plates 20 x 8 mm	(20 pieces per plate) 55318
Connection accessories		Art-No.
	Adapter Current /voltage converter Voltage/current converter	7000-42251-0000000 7000-42252-0000000
	MVK Push Pull Dust Protection Set	553260
	Ground strap 4 mm² 100 mm for screw (M4)	4000-71001-0410004
	Screw plug M23 Metal	55352
	Adapter plug M12/M12 for inputs	7030-42291-0000000

MVK METAL

Connection accessories			Art-No.
	<p>T-coupler (Slim Line) Male straight - female/male straight M12 - M12, 4-pole for 8-pole units</p>	<p>AIDA conform Connection cable L = 200 mm</p>	<p>7030-42602-0000000</p>
	<p>T-coupler (Slim Line) Male straight - female/male straight M12 - M12, 2-pole</p>	<p>AIDA conform Connection cable L = 200 mm</p>	<p>7030-42612-0000000</p>
	<p>T-coupler (SlimLine) M12 - M12 5-pole</p>		<p>7000-41155-0000000</p>
	<p>Cable fixation 8xM12 Cable diameter (4...7 mm)</p>		<p>55554</p>

SOLID67 COMPACT I/O-MODULES

- Shorter installation times and Using all slots
- Minimizing space requirements
- Simplifying storage

PROTOCOL CHANGE IN THE BLINK OF AN EYE

SOLID67 are the new compact I/O modules from Murrelektronik. They make installation in the field easier and are very attractive for applications with IO-Link sensors and actuators. They provide eight IO-Link slots directly adjacent to the process and can easily incorporate classic IOs into the system.

Full encapsulation and impressive vibration and shock values (15 and 50 G) prepare the modules for use in harsh industrial environments – within a temperature range of –20 to +70 °C. This opens a door to numerous applications. Comprehensive diagnostic options at the module, through the control unit, and through an integrated web server, make troubleshooting a simple exercise.

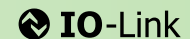

Shorter installation times



Using all slots

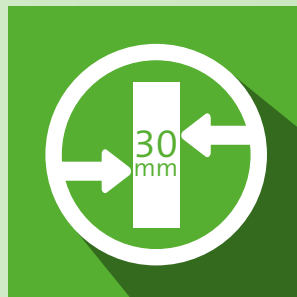

Minimizing space requirements



Simplifying storage

SOLID67 I/O-Modules



SOLID67 PN/E 60 mm
• Multi protocol



Page 4.5.1



SOLID67 PN/E 60 mm
• Multi protocol
• IOL8

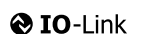

Page 4.5.3



SOLID67 PN/E 30 mm
• Multi protocol
• IOL8



Page 4.5.4

Multi protocol



SOLID67 PN/E

60 mm



Order Data	Art-No.	Art-No.
DI16	54500	
DI8 DO8		54501
Connections		
Fieldbus	Ethernet 10/100 Mbit/s; M12, D-coded	
Sensor-system/actuator supply	M12 Power, 5-pole, L-coded	
I/O ports	M12, 5-pole, A-coded	
PROFINET		
Addressing	DCP	
Shared Device/Input	-	
Profinet Netload Class	III	
Specification	V2.3, Conformance Class C (IRT)	
MRP	yes	
EtherNet/IP		
Addressing	DHCP, BOOTP or IP address by rotary switch	
QC (Quick Connect)	max. 500 ms	
DLR (Device Level Ring)	yes	
Input		
Sensor supply US	24 V DC (EN 61131-2), max. 200 mA (M12 female), short-circuit and overload protected	
Type	for 3-wire sensors or mechanical switches, PNP	
Output		
Actuator supply UA	-	24 V DC (EN 61131-2), max. 9 A
Switching current per output	-	max. 2 A (short-circuit and overload protected)
Parameterization		
PIN 4	Input (port X1...X8)	Input (port X1...X4); Output (port X5...X8)
PIN 2	Input (port X1...X8)	Input (port X1...X4); Output (port X5...X8)
General data		
Protection	IP67	
Mounting method	2-hole screw mounting	
Temperature range	-20...+70 °C	
Dimension drawing		

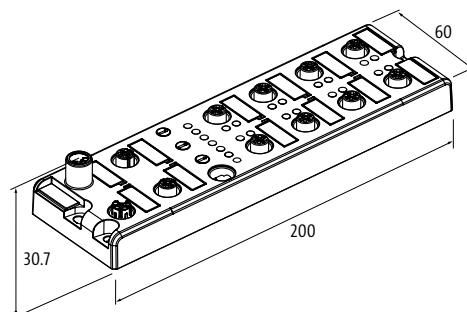

Notes

SOLID67

Multi protocol



SOLID67 PN/E

60 mm



Order Data	Art-No.	Art-No.
DIO16	54503	
DO16		54502
Connections		
Fieldbus	Ethernet 10/100 Mbit/s; M12, D-coded	
Sensor-system/actuator supply	M12 Power, 5-pole, L-coded	
I/O ports	M12, 5-pole, A-coded	
PROFINET		
Addressing	DCP	
Shared Device/Input	-	
Profinet Netload Class	III	
Specification	V2.3, Conformance Class C (IRT)	
MRP	yes	
EtherNet/IP		
Addressing	DHCP, BOOTP or IP address by rotary switch	
QC (Quick Connect)	max. 500 ms	
DLR (Device Level Ring)	yes	
Input		
Sensor supply US	24 V DC (EN 61131-2), max. 200 mA (M12 female), short-circuit and overload protected	-
Type	for 3-wire sensors or mechanical switches, PNP	-
Output		
Actuator supply UA	24 V DC (EN 61131-2), max. 9 A	
Switching current per output	max. 2 A (short-circuit and overload protected)	
Parameterization		
PIN 4	Input/Output (port X1...X8)	Output (port X1...X8)
PIN 2	Input/Output (port X1...X8)	Output (port X1...X8)
General data		
Protection	IP67	
Mounting method	2-hole screw mounting	
Temperature range	-20...+70 °C	
Dimension drawing		

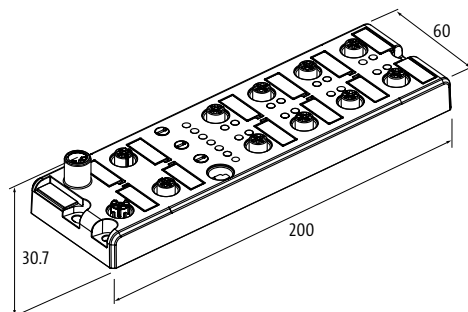

Notes

SOLID67

Multi protocol

PROFINET EtherNet/IP™

IO-Link

Approvals:  UL Listed

SOLID67 PN/E

IOL8
60 mm



Order Data	Art-No.
IOL8	54504
Connections	
Fieldbus	Ethernet 10/100 Mbit/s; M12, D-coded
Sensor-system/actuator supply	M12 Power, 5-pole, L-coded
I/O ports	M12, 5-pole, A-coded
PROFINET	
Addressing	DCP
Shared Device/Input	yes, for 2 controls
Profinet Netload Class	II
Specification	V2.3, Conformance Class C (IRT)
MRP	yes
EtherNet/IP	
Addressing	DHCP, BOOTP or IP address by rotary switch
DLR (Device Level Ring)	yes
IO-Link	
IO-Link	8 × Master
Operating modes	COM1; COM2; COM3 (automatic)
Transfer parameters	32 Input byte and/or 32 Output byte (per IO-Link port)
Port class	4 × A (port X1...X4), 4 × B (port X5...X8, galvanically separated, max. 2 A per port)
Specification	IO-Link Master V1.1
Input	
Sensor supply US	24 V DC (EN 61131-2), max. 500 mA (M12 female), short-circuit and overload protected
Type	for 3-wire sensors or mechanical switches, PNP, IO-Link Devices
Output	
Actuator supply UA	24 V DC (EN 61131-2), max. 9 A
Switching current per output	max. 0.5 A (PIN 4, X1...X8); 2 A (PIN 2/5 Uaux, X5...X8), short-circuit and overload protected
Parameterization	
PIN 4	Input (port X1...X8); Output (port X1...X8); IO-Link Master (port X1...X8)
PIN 2	Input (port X1...X4); Output (port X5...X8)
General data	
Protection	IP67
Mounting method	2-hole screw mounting
Temperature range	-20...+70 °C
Dimension drawing	

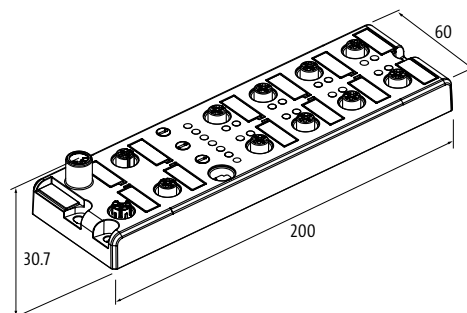

Notes

SOLID67

SOLID67

Multi protocol

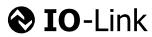

SOLID67 PN/E

IOL8
30 mm



SOLID67 PN/E

IOL8
30 mm



Order Data	Art-No.	Art-No.
IOL8	54505	54506
Connections		
Fieldbus	Ethernet 10/100 Mbit/s; M12, D-coded	
Sensor-system/actuator supply	M12 Power, 5-pole, L-coded	
I/O ports	M12, 5-pole, A-coded	M8, 5-pole, B-coded
PROFINET		
Addressing	DCP	
Shared Device/Input	yes, for 2 controls	
Profinet Netload Class	II	
Specification	V2.3, Conformance Class C (IRT)	
MRP	yes	
EtherNet/IP		
Addressing	DHCP, BOOTP or IP address by rotary switch	
DLR (Device Level Ring)	yes	
IO-Link		
IO-Link	8 × Master	
Operating modes	COM1; COM2; COM3 (automatic)	
Transfer parameters	32 Input byte and/or 32 Output byte (per IO-Link port)	
Port class	4 × A (port X1...X4), 4 × B (port X5...X8, galvanically separated, max. 4 A per module)	
Specification	IO-Link Master V1.1	
Input		
Sensor supply US	24 V DC (EN 61131-2), max. 500 mA (M12 female), short-circuit and overload protected	
Type	for 3-wire sensors or mechanical switches, PNP, IO-Link Devices	
Output		
Actuator supply UA	24 V DC (EN 61131-2), max. 9 A	
Switching current per output	max. 0.5 A (PIN 4, X1...X8), short-circuit and overload protected	
Parameterization		
PIN 4	Input (port X1...X8); Output (port X1...X8); IO-Link Master (port X1...X8)	
PIN 2	Input (port X1...X4)	
General data		
Protection	IP67	
Mounting method	2-hole screw mounting	
Temperature range	-20...+70 °C	
Dimension drawing		

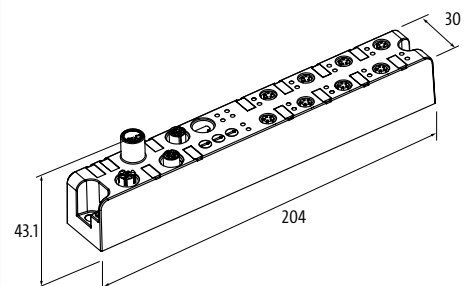
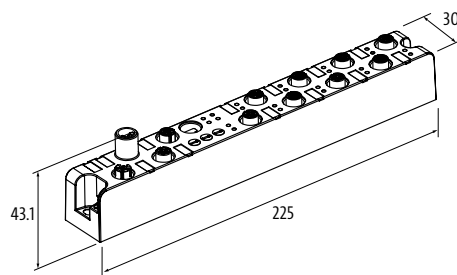

Notes

Blind plug/caps			Art-No.
	Screw plug M12 × 1 mm (for female) Plastic, hex without gasket	Quantity: 10 pcs.	58627
	Labeling accessories		
	Label plates 20 × 8 mm	(20 pieces per plate)	55318
		Label plate (KM 4) 5 × 10 mm	



IMPACT67 COMPACT I/O MODULES FOR THE FIELD

- Application oriented
- Easy to Install
- Cost-effective

ECONOMIC DECENTRALIZATION

Impact67 is the perfect fieldbus solution for basic applications that need to be cost-effective. The modules in this series are available with different bus protocols, they feature pluggable connections, diagnostics and IP67 tested seals.

This makes Impact67 the perfect choice for an electrical engineer whose objective is to minimize costs while maintaining digital inputs and outputs under ordinary conditions.

FOCUSED ON ESSENTIALS

- Single channel diagnostic via LED – don't look for errors, find them
- Group diagnostics via the bus – easy remote diagnostics
- Port-related shut off – only the affected port is shut off



EtherNet/IP

EtherCAT

CANopen

DeviceNet

IO-Link

Impact67 I/O Modules

 <p>Impact67-P • Digital I/Os</p>  <p>Page 4.6.1</p>	 <p>Impact67-PN • Multifunctional I/Os • Digital I/Os • IO-Link</p>  <p>IO-Link</p> <p>Page 4.6.2</p>
 <p>Impact67-E • Multifunctional I/Os • Digital I/Os • IO-Link</p>  <p>Page 4.6.5</p>	 <p>Impact67-EC • Digital I/Os</p>  <p>Page 4.6.8</p>
 <p>Impact67-C • Digital I/Os</p>  <p>Page 4.6.9</p>	 <p>Impact67-DN • Digital I/Os</p>  <p>Page 4.6.10</p>

IMPACT67

Basic diagnostic



Impact67-P

DI16

Impact67-P

DI8/DO8 - 2 A

Impact67-P

DO8 - 2 A

Impact67-P

DO16 - 0.5 A



Order Data	Art-No.	Art-No.	Art-No.	Art-No.
DI16	55345			
DI8/DO8 - 2 A		55346		
DO8 - 2 A			55347	
DO16 - 0.5 A				55348
Connections				
Fieldbus	PROFIBUS 12 Mbit/s; M12, B-coded			
Sensor-system/actuator supply	7/8", 5-pole, 2 x max. 9 A			
I/O ports	M12, 5-pole, A-coded			
PROFIBUS				
Addressing	Rotary switch 3...99			
Input				
Sensor supply US	24 V DC (EN 61131-2), max. 200 mA (M12 female), short-circuit and overload protected		-	
Type	for 3-wire sensors or mechanical switches, PNP		-	
Output				
Switching current per output	-		max. 2 A (short-circuit and overload protected)	max. 0.5 A (short-circuit and overload protected)
General data				
Protection	IP67			
Mounting method	2 hole screw mounting, compatible with I/O modules of MVK model range			
Temperature range	0...+55 °C (storage temperature -25...+70 °C)			
Dimension drawing				

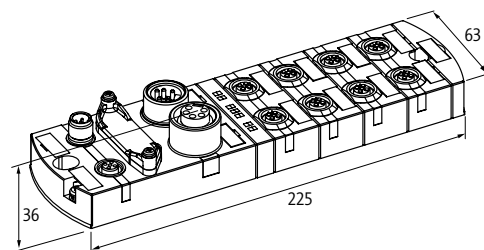

Notes	
--------------	--

IMPACT67

Basic diagnostic



Impact67-PN

DI16

Impact67-PN

DI8/DO8 - 2 A

Impact67-PN

DO8 - 2 A

Impact67-PN

DO16 - 0.5 A



Order Data	Art-No.	Art-No.	Art-No.	Art-No.
DI16	55091			
DI8/DO8 - 2 A		55092		
DO8 - 2 A			55093	
DO16 - 0.5 A				55094

Connections

Fieldbus	Ethernet 10/100 Mbit/s; M12, D-coded
Sensor-system/actuator supply	7/8", 5-pole, 2 × max. 9 A
I/O ports	M12, 5-pole, A-coded

PROFINET

Addressing	DCP
------------	-----

Input

Sensor supply US	24 V DC (EN 61131-2), max. 200 mA (M12 female), short-circuit and overload protected	-
Type	for 3-wire sensors or mechanical switches, PNP	-

Output

Switching current per output	-	max. 2 A (short-circuit and overload protected)	max. 0.5 A (short-circuit and overload protected)
------------------------------	---	---	---

General data

Protection	IP67
Mounting method	2 hole screw mounting, compatible with I/O modules of MVK model range
Temperature range	-25...+55 °C (storage temperature -25...+70 °C)

Dimension drawing

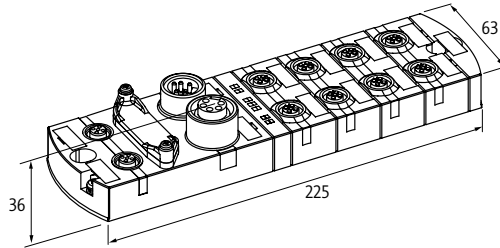

Notes

IMPACT67

Expanded diagnostic



Impact67-PN

DIO16 IRT



Order Data	Art-No.
DIO16 IRT	55130
Connections	
Fieldbus	Ethernet 10/100 Mbit/s; M12, D-coded
Sensor-system/actuator supply	7/8", 5-pole, 2 × max. 9 A
I/O ports	M12, 5-pole, A-coded
PROFINET	
FSU (Fast-Start-Up)	max. 500 ms
Shared Device/Input	yes, for 2 controls
Profinet Netload Class	III
Specification	V2.3, Conformance Class C (IRT)
Addressing	DCP
Input	
Sensor supply US	24 V DC (EN 61131-2), max. 200 mA (M12 female), short-circuit and overload protected
Type	for 3-wire sensors or mechanical switches, PNP
Output	
Actuator supply UA	24 V DC (EN 61131-2), max. 9 A
Switching current per output	max. 1.6 A (short-circuit and overload protected)
Lamp load	10 W
Parameterization	
PIN 4	Input/Output (port X0...X7)
PIN 2	Input/Output (port X0...X7)
General data	
Protection	IP67
Mounting method	2-hole screw mounting
Temperature range	-25...+55 °C (storage temperature -25...+70 °C)
Dimension drawing	

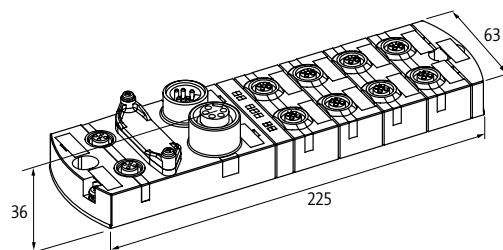

Notes

IMPACT67

Expanded diagnostic



Impact67-PN IO-Link

DIO14 IOL2 IRT



Impact67-PN IO-Link

DIO12 IOL4 IRT



Order Data	Art-No.	Art-No.
DIO14 IOL2 IRT	55131	
DIO12 IOL4 IRT		55132
Connections		
Fieldbus	Ethernet 10/100 Mbit/s; M12, D-coded	
Sensor-system/actuator supply	7/8", 5-pole, 2 × max. 9 A	
I/O ports	M12, 5-pole, A-coded	
PROFINET		
FSU (Fast-Start-Up)	max. 500 ms	
Shared Device/Input	yes, for 2 controls	
Profinet Netload Class	III	
Specification	V2.3, Conformance Class C (IRT)	
Addressing	DCP	
IO-Link		
IO-Link	2 × Master	4 × Master
Operating modes	COM1; COM2; COM3 (automatic)	
Transfer parameters	32 Byte (via IO-Link Port)	
Port class	Class B (not galvanically separated)	Class A + B (not galvanically separated)
Specification	IO-Link Master V1.12	
Input		
Sensor supply US	24 V DC (EN 61131-2), max. 200 mA (M12 female), short-circuit and overload protected	
Type	for 3-wire sensors or mechanical switches, PNP, IO-Link Devices	
Output		
Actuator supply UA	24 V DC (EN 61131-2), max. 9 A	
Switching current per output	max. 1.6 A (short-circuit and overload protected)	
Lamp load	10 W	
Parameterization		
PIN 4	Input (port X0...X7); Output (port X0...X4, X6); IO-Link Master (port X5, X7)	Input (port X0...X7); Output (port X0, X2, X4, X6); IO-Link Master (port X1, X3, X5, X7)
PIN 2	Input/Output (port X0...X7); U-Actuator IO-Link Class B (port X5, X7)	
General data		
Protection	IP67	
Mounting method	2-hole screw mounting	2 hole screw mounting, compatible with I/O modules of MVK model range
Temperature range	-25...+55 °C (storage temperature -25...+70 °C)	
Dimension drawing		

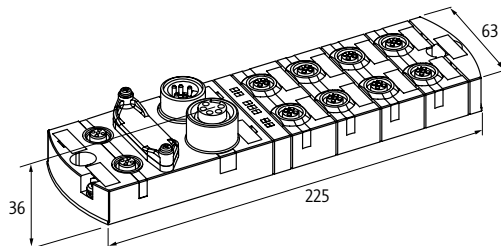

Notes

IMPACT67

Basic diagnostic

EtherNet/IP

Impact67-E

DI16

Impact67-E

DI8/DO8 - 2 A

Impact67-E

DO8 - 2 A

Impact67-E

DO16 - 0.5 A



Approvals:  

Order Data	Art-No.	Art-No.	Art-No.	Art-No.
DI16	55085			
DI8/DO8 - 2 A		55086		
DO8 - 2 A			55087	
DO16 - 0.5 A				55088
Connections				
Fieldbus	Ethernet 10/100 Mbit/s; M12, D-coded			
Sensor-system/actuator supply	7/8", 5-pole, 2 × max. 9 A			
I/O ports	M12, 5-pole, A-coded			
EtherNet/IP				
Addressing	DHCP, BOOTP or IP address by rotary switch			
Input				
Sensor supply US	24 V DC (EN 61131-2), max. 200 mA (M12 female), short-circuit and overload protected		-	
Type	for 3-wire sensors or mechanical switches, PNP		-	
Output				
Switching current per output	-	max. 2 A (short-circuit and overload protected)	max. 0.5 A (short-circuit and overload protected)	
General data				
Protection	IP67			
Mounting method	2 hole screw mounting, compatible with I/O modules of MVK model range			
Temperature range	-25...+55 °C (storage temperature -25...+70 °C)		0...+55 °C (storage temperature -25...+70 °C)	
Dimension drawing				

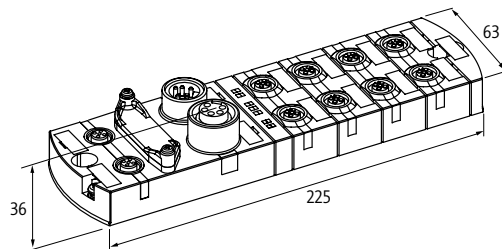

Notes

IMPACT67

Expanded diagnostic

EtherNet/IP™

Approvals:  

Impact67-E

DIO8 (DIO8)
DLR (Device Level Ring)

Impact67-E

DIO16
DLR (Device Level Ring)



Order Data	Art-No.	Art-No.
DIO8 (DIO8)	55089	
DIO16		55142
Connections		
Fieldbus	Ethernet 10/100 Mbit/s; M12, D-coded	
Sensor-system/actuator supply	7/8", 5-pole, 2 × max. 9 A	7/8", 4-pole, 2 × max. 9 A
I/O ports	M12, 5-pole, A-coded	
EtherNet/IP		
Addressing	DHCP, BOOTP or IP address by rotary switch	DHCP, BOOTP or IP address by DIP switch
DLR (Device Level Ring)	yes	
QC (Quick Connect)	–	max. 360 ms
Multiple connections	–	yes
CIP Sync	–	yes
Composite Test Revision	–	CT14
Input		
Sensor supply US	24 V DC (EN 61131-2), max. 200 mA (M12 female), short-circuit and overload protected	
Type	for 3-wire sensors or mechanical switches, PNP	
Output		
Actuator supply UA	24 V DC (EN 61131-2), max. 9 A	
Switching current per output	max. 1.6 A (short-circuit and overload protected)	
Lamp load	10 W	
Parameterization		
PIN 4	Input/Output (port X0...X7)	
PIN 2	Input/Output (port X0...X7)	
General data		
Protection	IP67	
Mounting method	2 hole screw mounting, compatible with I/O modules of MVK model range	2-hole screw mounting
Temperature range	-25...+55 °C (storage temperature -25...+70 °C)	-25...+55 °C (storage temperature -40...+85 °C)
Dimension drawing		

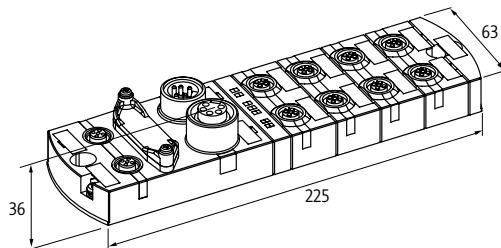

Notes

IMPACT67

Expanded diagnostic

EtherNet/IP  IO-Link

Impact67-E IO-Link

DIO14 IOL2
DLR (Device Level Ring)

Impact67-E IO-Link

DIO12 IOL4
DLR (Device Level Ring)



Approvals:  

Order Data	Art-No.	Art-No.
DIO14 IOL2	55143	
DIO12 IOL4		55144
Connections		
Fieldbus	Ethernet 10/100 Mbit/s; M12, D-coded	
Sensor-system/actuator supply	7/8", 4-pole, 2 × max. 9 A	
I/O ports	M12, 5-pole, A-coded	
EtherNet/IP		
Addressing	DHCP, BOOTP or IP address by DIP switch	
QC (Quick Connect)	max. 360 ms	
Multiple connections	yes	
CIP Sync	yes	
Composite Test Revision	CT14	
DLR (Device Level Ring)	yes	
IO-Link		
IO-Link	2 × Master	4 × Master
Operating modes	COM1; COM2; COM3 (automatic)	
Transfer parameters	32 Byte (via IO-Link Port)	
Port class	Class B (not galvanically separated)	
Specification	IO-Link Master V1.12	
Input		
Sensor supply US	24 V DC (EN 61131-2), max. 200 mA (M12 female), short-circuit and overload protected	
Type	for 3-wire sensors or mechanical switches, PNP, IO-Link Devices	
Output		
Actuator supply UA	24 V DC (EN 61131-2), max. 9 A	
Switching current per output	max. 1.6 A (short-circuit and overload protected)	
Lamp load	10 W	
Parameterization		
PIN 4	Input/Output (port X0...X7); IO-Link Master (port X6, X7)	Input/Output (port X0...X7); IO-Link Master (port X4...X7)
PIN 2	Input/Output (port X0...X7); U-Actuator IO-Link Class B (port X6, X7)	Input/Output (port X0...X7); U-Actuator IO-Link Class B (port X4...X7)
General data		
Protection	IP67	
Mounting method	2-hole screw mounting	
Temperature range	-25...+55 °C (storage temperature -40...+85 °C)	
Dimension drawing		

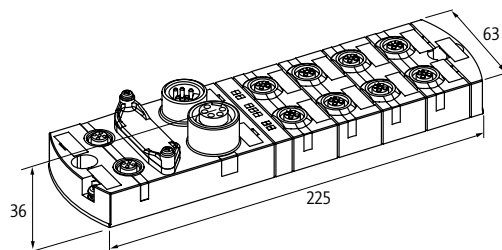

Notes

IMPACT67

Basic diagnostic

EtherCAT

Approvals:  

Impact67-EC
DI16

Impact67-EC
DI8/DO8 - 2 A

Impact67-EC
DO8 - 2 A

Impact67-EC
DO16 - 0.5 A



Order Data	Art-No.	Art-No.	Art-No.	Art-No.
DI16	55081			
DI8/DO8 - 2 A		55082		
DO8 - 2 A			55083	
DO16 - 0.5 A				55084
Connections				
Fieldbus	Ethernet 10/100 Mbit/s; M12, D-coded			
Sensor-system/actuator supply	7/8", 5-pole, 2 × max. 9 A			
I/O ports	M12, 5-pole, A-coded			
EtherCAT				
Addressing	automatic or Device ID by rotary switch			
Input				
Sensor supply US	24 V DC (EN 61131-2), max. 200 mA (M12 female), short-circuit and overload protected		-	
Type	for 3-wire sensors or mechanical switches, PNP		-	
Output				
Switching current per output	-	max. 2 A (short-circuit and overload protected)		max. 0.5 A (short-circuit and overload protected)
General data				
Protection	IP67			
Mounting method	2 hole screw mounting, compatible with I/O modules of MVK model range			
Temperature range	-25...+55 °C (storage temperature -25...+70 °C)			0...+55 °C (storage temperature -25...+70 °C)
Dimension drawing				

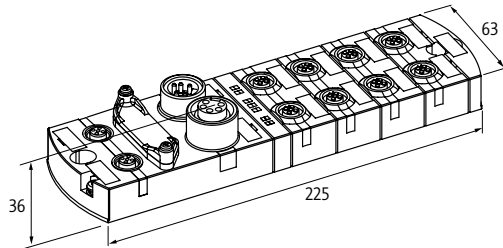

Notes

IMPACT67

Basic diagnostic

CANopen

Impact67-C

DI16

Impact67-C

DI8/DO8 - 2 A

Impact67-C

DO8 - 2 A

Impact67-C

DO16 - 0.5 A



Approvals:  

Order Data	Art-No.	Art-No.	Art-No.	Art-No.
DI16	55075			
DI8/DO8 - 2 A		55076		
DO8 - 2 A			55077	
DO16 - 0.5 A				55078
Connections				
Fieldbus	CAN 1 Mbit/s; M12, A-coded			
Sensor-system/actuator supply	7/8", 5-pole, 2 × max. 9 A			
I/O ports	M12, 5-pole, A-coded			
CANopen				
Addressing	Rotary switch 1...99			
Input				
Sensor supply US	24 V DC (EN 61131-2), max. 200 mA (M12 female), short-circuit and overload protected		-	
Type	for 3-wire sensors or mechanical switches, PNP	-		
Output				
Switching current per output	-	max. 2 A (short-circuit and overload protected)	max. 0.5 A (short-circuit and overload protected)	
General data				
Protection	IP67			
Mounting method	2 hole screw mounting, compatible with I/O modules of MVK model range			
Temperature range	-25...+70 °C (storage temperature -25...+70 °C)			
Dimension drawing				

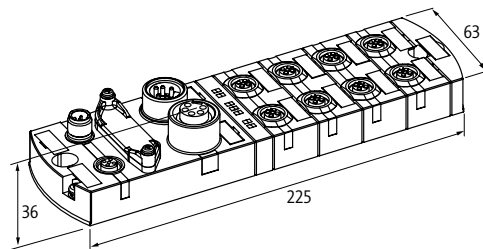

Notes	
--------------	--

IMPACT67

Basic diagnostic

DeviceNet

Impact67-DN

DI16

Impact67-DN

DI8/DO8 - 2 A

Impact67-DN

DO8 - 2 A

Impact67-DN

DO16 - 0.5 A



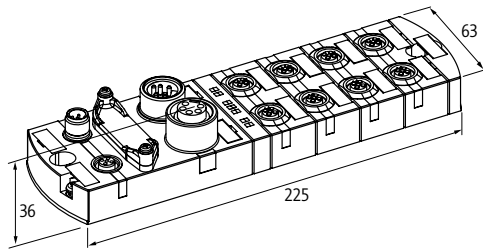

Approvals:  

Order Data	Art-No.	Art-No.	Art-No.	Art-No.
DI16	55071			
DI8/DO8 - 2 A		55072		
DO8 - 2 A			55073	
DO16 - 0.5 A				55074
Connections				
Fieldbus	DN 125 kbit/s; 250 kbit/s; 500 kbit/s; M12, A-coded			
Sensor-system/actuator supply	7/8", 5-pole, 2 × max. 9 A			
I/O ports	M12, 5-pole, A-coded			
DeviceNet				
Addressing	Rotary switch 0...63			
Input				
Sensor supply US	24 V DC (EN 61131-2), max. 200 mA (M12 female), short-circuit and overload protected		-	
Type	for 3-wire sensors or mechanical switches, PNP		-	
Output				
Switching current per output	-	max. 2 A (short-circuit and overload protected)	max. 0.5 A (short-circuit and overload protected)	
General data				
Protection	IP67			
Mounting method	2 hole screw mounting, compatible with I/O modules of MVK model range			
Temperature range	-25...+70 °C (storage temperature -25...+70 °C)			
Dimension drawing				



Notes

Accessories			Art-No.
	<p>Label plates 20 × 8 mm</p>	<p>(20 pieces per plate)</p>	<p>55318</p>
	<p>Screw plug M12 × 1 mm (for female) Plastic, hex without gasket</p>	<p>Quantity: 10 pcs.</p>	<p>58627</p>
	<p>Screw plug 7/8" (for male) Plastic</p>		<p>55385</p>

IO-LINK DEVICES

INTELLIGENT NETWORKING

- Flexible
- Easy handling
- Economical

IO-LINK ANALOG CONVERTER

The IO-Link analog converter from Murrelektronik can be used to connect regular analog sensors and actuators easily to the IO-Link master.

IO-LINK COUPLER

The IO-Link inductive couplers from Murrelektronik are designed for a non-contact transmission of energy and bi-directional IO-Link communication through an air gap. This prevents mechanical wear and is ideally suited to replace intensively stressed plug-in or looped connections.

IO-LINK HUB

The IO-Link hubs from Murrelektronik can be used to connect several digital sensors and actuators easily to the IO-Link master ports via a standard sensor cable.

 **IO-Link**
by Murrelektronik

IO-LINK DEVICES



IO-Link/Analog Converters

- Analog inputs
- Analog outputs

Page 4.7.1



IO-Link Coupler

- Primary
- Secondary

Page 4.7.7



IO-Link Hubs

- Metal version
- Plastic version

Page 4.7.8

IO-LINK DEVICES

Analog inputs

– Plug & Play

– IO-Link V1.1

 IO-Link

Approvals: 

IO-Link/Analog Converter

Current



Contact layout

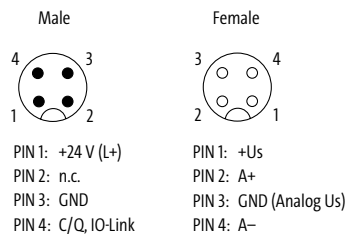

Order Data

INPUT: 0...20 mA

Art-No.

5000-00501-110000

INPUT: 4...20 mA

5000-00501-111000

Connections

IO-Link M12 (male) 5-pole, A-coded

Analog input M12 (female) 5-pole, A-coded, shielded

Module Supply

Operating voltage 24 V DC (18...30 V DC)

IO-Link

Specification IO-Link V1.1

Operating modes COM2 (38.4 kBit/s)

Port class A

Cycle time min. 2.3 ms

Data width 16 Bit / 2 Byte

Input

Sensor supply US 24 V DC (EN 61131-2), max. 200 mA

Resolution (analog) 15 Bit + sign

Accuracy 0.10% (25° C)

Conversion time (analog) max. 5 ms

Parameterization

Diagnostics lower limit, upper limit, over heated, supply over voltage, supply under voltage, defective device, sensor supply over current, overrun

General data

Protection IP65/IP67

Temperature range -30...+70 °C (storage temperature -40...+85 °C)

Dimension drawing

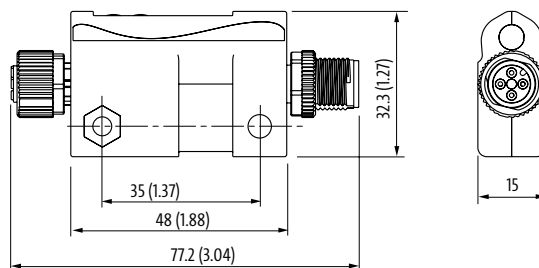

Notes

IO-LINK DEVICES

Analog inputs

– Plug & Play

– IO-Link V1.1

 IO-Link

Approvals:  Listed

IO-Link/Analog Converter

Voltage



Contact layout

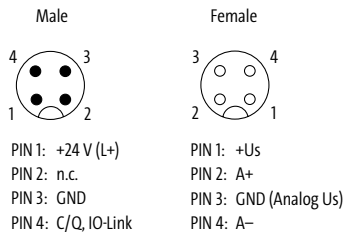

Order Data	Art-No.
INPUT: 0...10 V	5000-00501-1200000
INPUT: -10...+10 V	5000-00501-1210000

Connections	
IO-Link	M12 (male) 5-pole, A-coded
Analog input	M12 (female) 5-pole, A-coded, shielded

Module Supply	
Operating voltage	24 V DC (18...30 V DC)

IO-Link	
Specification	IO-Link V1.1
Operating modes	COM2 (38.4 kBit/s)
Port class	A
Cycle time	min. 2.3 ms
Data width	16 Bit / 2 Byte

Input	
Sensor supply US	24 V DC (EN 61131-2), max. 200 mA
Resolution (analog)	15 Bit + sign
Accuracy	0.10% (25° C)
Conversion time (analog)	max. 5 ms

Parameterization	
Diagnostics	lower limit, upper limit, over heated, supply over voltage, supply under voltage, defective device, sensor supply over current, overrun

General data	
Protection	IP65/IP67
Temperature range	-30...+70 °C (storage temperature -40...+85 °C)

Dimension drawing

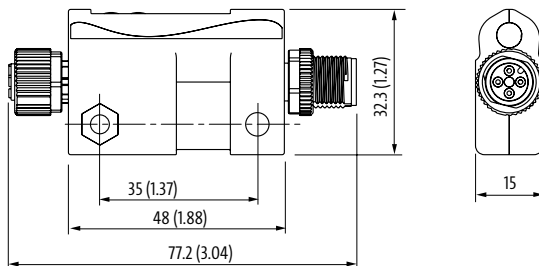

Notes

IO-LINK DEVICES

Analog inputs

– Multifunctional

– IO-Link V1.1

 IO-Link

Approvals: 

IO-Link/Analog Converter

Current/Voltage



Contact layout

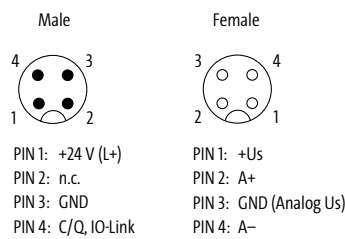

Order Data

INPUT: 0...20 mA, 4...20 mA, 0...10 V, -10...+10 V

Art-No.

5000-00501-1300001

Connections

IO-Link M12 (male) 5-pole, A-coded
 Analog input M12 (female) 5-pole, A-coded, shielded

Module Supply

Operating voltage 24 V DC (18...30 V DC)

IO-Link

Specification IO-Link V1.1
 Operating modes COM2 (38.4 kBit/s)
 Port class A
 Cycle time min. 2.3 ms
 Data width 16 Bit / 2 Byte

Input

Sensor supply US 24 V DC (EN 61131-2), max. 200 mA
 Resolution (analog) 15 Bit + sign
 Accuracy 0.10% (25° C)
 Conversion time (analog) max. 5 ms

Parameterization

Diagnostics 2 Byte

General data

Protection IP65/IP67
 Temperature range -30...+70 °C (storage temperature -40...+85 °C)

Dimension drawing

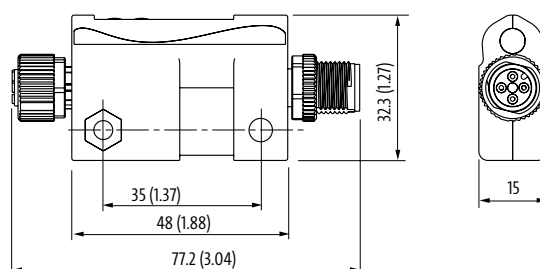

Notes

IO-LINK DEVICES

Analog outputs

– Plug & Play

– IO-Link V1.1

 IO-Link

Approvals:  Listed

IO-Link/Analog Converter

Current



Contact layout

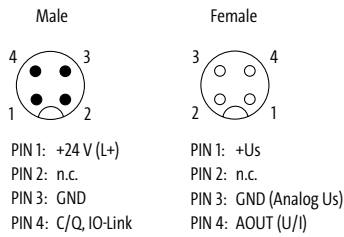

Order Data	Art-No.
OUTPUT: 0...20 mA	5000-00501-2100000
OUTPUT: 4...20 mA	5000-00501-2110000

Connections	
IO-Link	M12 (male) 5-pole, A-coded
Analog output	M12 (female) 5-pole, A-coded, shielded

Module Supply	
Operating voltage	24 V DC (18...30 V DC)

IO-Link	
Specification	IO-Link V1.1
Operating modes	COM2 (38.4 kBit/s)
Port class	A
Cycle time	min. 2.3 ms
Data width	16 Bit / 2 Byte

Output	
Actuator supply UA	24 V DC (EN 61131-2), max. 200 mA
Resolution (analog)	15 Bit + sign
Type	2-, 3-, 4-wire technology
Accuracy	0.10% (25° C)
Conversion time (analog)	max. 5 ms
Over voltage protection	30 V DC

Parameterization	
Diagnostics	lower limit, upper limit, over heated, supply over voltage, supply under voltage, defective device, sensor cable break, sensor supply over current, overrun

General data	
Protection	IP65/IP67
Temperature range	-30...+70 °C (storage temperature -40...+85 °C)

Dimension drawing

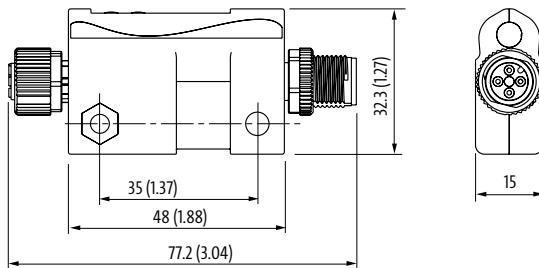

Notes

IO-LINK DEVICES

Analog outputs

– Plug & Play

– IO-Link V1.1

 IO-Link

Approvals:  Listed

IO-Link/Analog Converter

Voltage



Contact layout

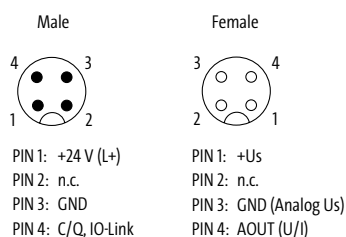

Order Data

OUTPUT: 0...10 V

Art-No.

5000-00501-2200000

OUTPUT: -10...+10 V

5000-00501-2210000

Connections

IO-Link M12 (male) 5-pole, A-coded

Analog output M12 (female) 5-pole, A-coded, shielded

Module Supply

Operating voltage 24 V DC (18...30 V DC)

IO-Link

Specification IO-Link V1.1

Operating modes COM2 (38.4 kBit/s)

Port class A

Cycle time min. 2.3 ms

Data width 16 Bit / 2 Byte

Output

Actuator supply UA 24 V DC (EN 61131-2), max. 200 mA

Resolution (analog) 15 Bit + sign

Type 2-, 3-, 4-wire technology

Accuracy 0.10% (25° C)

Conversion time (analog) max. 5 ms

Over voltage protection 30 V DC

Parameterization

Diagnostics lower limit, upper limit, over heated, supply over voltage, supply under voltage, defective device, sensor cable break, sensor supply over current, overrun

General data

Protection IP65/IP67

Temperature range -30...+70 °C (storage temperature -40...+85 °C)

Dimension drawing

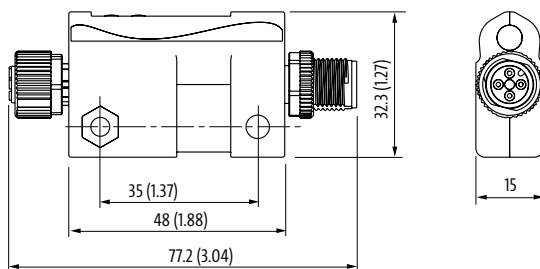

Notes

IO-LINK DEVICES

Analog outputs

– Multifunctional

– IO-Link V1.1

 IO-Link

Approvals:  Listed

IO-Link/Analog Converter

Current/Voltage



Contact layout

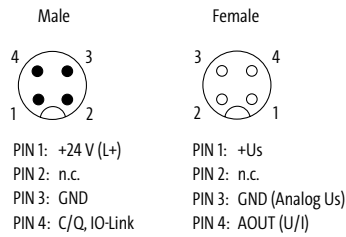

Order Data	Art-No.
OUTPUT: 0...20 mA, 4...20 mA, 0...10 V, -10...+10 V	5000-00501-2300001

Connections

IO-Link	M12 (male) 5-pole, A-coded
Analog output	M12 (female) 5-pole, A-coded, shielded

Module Supply

Operating voltage	24 V DC (18...30 V DC)
-------------------	------------------------

IO-Link

Specification	IO-Link V1.1
Operating modes	COM2 (38.4 kBit/s)
Port class	A
Cycle time	min. 2.3 ms
Data width	16 Bit / 2 Byte

Output

Actuator supply UA	24 V DC (EN 61131-2), max. 200 mA
Resolution (analog)	15 Bit + sign
Type	2-, 3-, 4-wire technology
Accuracy	0.10% (25° C)
Conversion time (analog)	max. 5 ms
Over voltage protection	30 V DC

Parameterization

Diagnostics	lower limit, upper limit, over heated, supply over voltage, supply under voltage, defective device, sensor cable break, sensor supply over current, overrun
-------------	---

General data

Protection	IP65/IP67
Temperature range	-30...+70 °C (storage temperature -40...+85 °C)

Dimension drawing

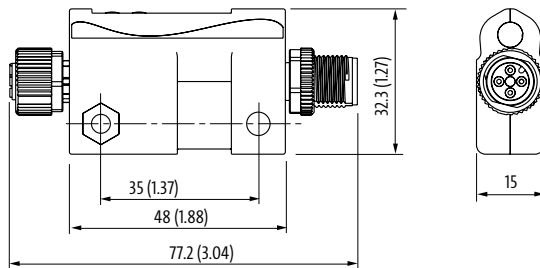

Notes

IO-LINK DEVICES

IO-Link V1.1

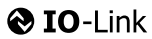

IO-Link Coupler (prim.)



IO-Link Coupler (sec.)

Connection cable L = 300 mm



Order Data	Art-No.	Art-No.
Primary	59450	
Secondary		59451
Accessories	Art-No.	
M30 holder		59452
Connections		
IO-Link	M12 (male) 4-pole, A-coded	M12 (female) 4-pole, A-coded
Technical Data		
Nominal distance	0...7 mm (prim./sec.)	
Standby power (coupled)	4 W	
Standby power (uncoupled)	1 W	
Short circuit protection	yes	
Invers-polarity protection	yes	
Start-/coupling time		10 ms
Rotation	1250 rpm	
Standby time		160 ms
Supply (prim.)		
Operating voltage	24 V DC ±10%	–
Operating current	750 mA	–
Output (sec.)		
Operating voltage	–	24 V DC ±10%
Output current	–	500 mA
Highest current	–	2.4 A (0.1 ms); 10 A (0.02 ms)
IO-Link		
Specification	IO-Link V1.1	
Operating modes	COM2 (38.4 kBit/s)	
Port class	A	
General data		
Protection	IP67/IP68	
Temperature range	-20...+55 °C	
Dimension drawing		

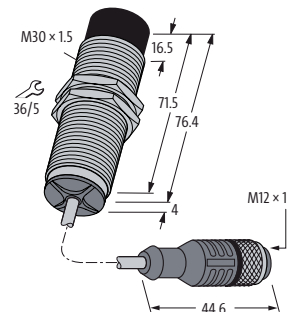
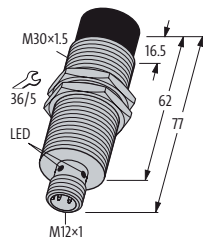

Notes

IO-LINK DEVICES

Expanded diagnostic

– IO-Link V1.1

– Single channel diagnostic

 IO-Link

IO-Link Hub

Galvanic isolation

IO-Link Hub



Order Data	Art-No.	Art-No.
DI8 DO8 IOL - K3	55518	
DI16 IOL		55519
Internal communication		
Current consumption	max. 35 mA	
LED display	US: sensor supply (green: OK); IOL: (green: OK); UA: actuator supply (green: OK)	US: sensor supply (green: OK); IOL: (green: OK)
IO-Link		
IO-Link	Device	
Operating modes	COM2 (38.4 kBaud)	
Transfer parameters	1 Byte (Inputs), 1 Byte (Outputs), 2 Byte (Diagnostic)	2 Byte (Inputs), 1 Byte (Diagnostic)
Port class	B	A
Specification	IO-Link V1.1	
Cycle time	2.3 ms	
Input		
Sensor supply US	24 V DC (EN 61131-2), max. 100 mA (M12 female), short-circuit and overload protected	
Type	PNP (EN 61131-2) Type 3	
Input filter	1 ms	
Input delay time	max. 8 ms (incl. IO-Link cycle time)	
Output		
Actuator supply UA	24 V DC (EN 61131-2), max. 4 A	–
Switching current per output	max. 0.4 A (short-circuit and overload protected)	–
Parameterization		
PIN 2	Input (port 0...3); Output (port 4...7)	Input
PIN 4	Input (port 0...3); Output (port 4...7)	Input
General data		
Protection	IP67	
Mounting method	4 hole screw mounting	
Temperature range	-25...+70 °C (storage temperature -40...+70 °C)	
Dimension drawing		

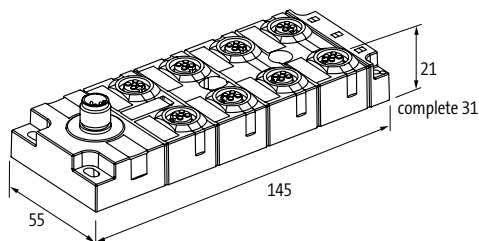

Notes

IO-LINK DEVICES

IO-Link V1.1



IO-Link Hub





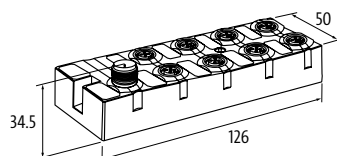



Order Data	Art-No.	Art-No.
D18 D08 IOL	59402	
D116 IOL		59401
Internal communication		
Current consumption	max. 35 mA	
LED display	US-IOL: sensor supply-IOL (green: OK); UA: actuator supply (green: OK)	US: sensor supply (green: OK); IOL: (green: OK)
IO-Link		
IO-Link	Device	
Operating modes	COM2 (38.4 kBaud)	
Transfer parameters	1 Byte (Inputs), 1 Byte (Outputs), 2 Byte (Diagnostic)	2 Byte (Inputs), 1 Byte (Diagnostic)
Port class	B	A
Specification	IO-Link V1.1	
Cycle time	2.3 ms	
Input		
Sensor supply US	24 V DC (EN 61131-2), max. 100 mA (M12 female), short-circuit and overload protected	
Type	PNP (EN 61131-2) Type 3	
Input filter	1 ms	
Input delay time	max. 8 ms (incl. IO-Link cycle time)	
Output		
Actuator supply UA	24 V DC (EN 61131-2), max. 4 A	–
Switching current per output	max. 0.4 A (short-circuit and overload protected)	–
Parameterization		
PIN 2	Input (port 0...3); Output (port 4...7)	Input
PIN 4	Input (port 0...3); Output (port 4...7)	Input
General data		
Protection	IP67	
Mounting method	2-hole screw mounting	
Temperature range	-25...+70 °C (storage temperature -40...+70 °C)	
Dimension drawing		



Notes

IO-LINK DEVICES

Accessories			Art-No.
	Label plates 20 × 8 mm	(20 pieces per plate)	55318
	Screw plug M12 × 1 mm (for female) Plastic, hex without gasket	Quantity: 10 pcs.	58627
	M30 holder		59452
	Holding plate for T-couplers M12 (SlimLine)	without mounting set	7000-99061-000000
	Holding plate for T-couplers M12 (SlimLine)	with mounting set	7000-99062-000000
	T-coupler (Slim Line) IO-Link IO-Link supply power		7000-42771-000000



MASI FOR THE CONTROL CABINET

- High signal density in a minimum amount of space
- Pluggable insulation displacement or spring clamp connections
- Sensor power supply from AS-Interface or 24 V DC

MASI – THE CLEVER AS-INTERFACE SYSTEM FROM MURRELEKTRONIK

The modules are designed in a way that the wiring method with single strands is optimally supported in order to offer the user the best possible benefit during installation, commissioning and maintenance.

The design according to the latest AS-Interface specification 3.0 and the AS-Interface certificate with worldwide validity guarantee the user interoperability and a high investment security. Furthermore, safety shutdowns according to EN 13849-1 up to PL d can be realized using a special K3 module.



➤ MASI

I/O modules, accessories and accompanying information material regarding MASI can be found in the **online shop**:

➤ shop.murrelektronik.com

Gateway



Gateway Singlemaster



Page 4.8.1



Gateway Doublemaster



Page 4.8.1

MAS100/MAS120



MAS100

- Digital inputs/outputs
- Degree of protection IP00

Page 4.8.2



MAS120

- Digital inputs/outputs
- Passively safe outputs
- Degree of protection IP20

Page 4.8.3

Power Supply Units



Primary switched power supply





- Single-phase, three-phase

Page 4.8.4

MASI CONTROL CABINET

PROFIBUS DP		Art-No.
	Gateway-Singlemaster AS-Interface/PROFIBUS DP No. of slaves ASI-Power 24 Serial interface/diagnostic AS-Interface data decoupling integrated	Protection IP20 max. 62 Specification 3.0 - Protection AS-i side, 4 A
		56471
PROFINET		Art-No.
	Gateway-Singlemaster AS-Interface/PROFINET No. of slaves ASI-Power 24 Serial interface/diagnostic AS-Interface data decoupling integrated	Protection IP20 max. 62 Specification 3.0 RJ45/Fieldbus Protection AS-i side, 4 A
		56470
EtherNet/IP		Art-No.
	Gateway-Singlemaster AS-Interface/EtherNet/IP No. of slaves ASI-Power 24 Serial interface/diagnostic AS-Interface data decoupling integrated	Protection IP20 max. 62 Specification 3.0 RJ45/Fieldbus Protection AS-i side, 4 A
		56469
CC-Link		Art-No.
	Gateway-Singlemaster AS-Interface/CC-Link No. of slaves ASI-Power 24 Serial interface/diagnostic AS-Interface data decoupling integrated	Protection IP20 max. 62 Specification 3.0 - Protection AS-i side, 4 A
		56473
EtherCAT		Art-No.
	Gateway-Doublemaster AS-Interface/EtherCAT No. of slaves AS-Interface data decoupling integrated Serial interface/diagnostic	Protection IP20 max. 2 × 62 Specification 3.0 RJ45/Ethernet Protection AS-i side, 4 A
		56458

MASI CONTROL CABINET

MASI00			Art-No.
	Digital inputs/outputs DI4/DO4 - 0.2 A Sensor supply US Switching current per output Profile (IO/ID/ID2 code) Address range Standard-Slave	Protection IP00 max. 200 mA (AS-Interface) max. 30 mA S-7.FF 1...31 via plug terminals Specification 3.0	55700
	DI4/DO4 - 0.2 A (AB) Sensor supply US Switching current per output Profile (IO/ID/ID2 code) Address range AB-Slave	Protection IP00 max. 200 mA (AS-Interface) max. 30 mA S-7.A.7 1...62 (1...31 A or B) via plug-in terminal Specification 3.0	55701
	Digital inputs/outputs DI4/DO4 - 0.2 A Sensor supply US Switching current per output Connection cable for pin cable lug Profile (IO/ID/ID2 code) Address range Standard-Slave	Protection IP00 max. 200 mA (AS-Interface) max. 30 mA 250 mm S-7.FF 1...31 via plug terminals Specification 3.0	556625
	DI4/DO4 - 0.2 A (AB) Sensor supply US Switching current per output Connection cable for pin cable lug Profile (IO/ID/ID2 code) Address range AB-Slave	Protection IP00 max. 200 mA (AS-Interface) max. 30 mA 250 mm S-7.A.7 1...62 (1...31 A or B) via plug-in terminal Specification 3.0	556639
	Connection cable MASI00 with open ended wires	1 000 mm	556510
	Connection cable MASI00 with cable fork	150 mm	556511

MASI20			Art-No.
	<p>Digital inputs/outputs DI4 - 0.2 A DO4 - 0.5 A (AB) K3 Sensor supply US Switching current per output Profile (IO/ID/ID2 code) Address range AB-Slave passive safe outputs</p>	<p>Protection IP20 from AS-Interface or 24 V DC (EN 61131-2) max. 0.5 A S-7.A.7 1...62 (1...31 A or B) Specification 3.0 can be switched off via safety relays</p>	<p>56440</p>
	<p>Digital inputs/outputs DI4 - 0.15 A DO4 - 2 A K3 Sensor supply US Switching current per output Profile (IO/ID/ID2 code) Address range Standard-Slave passive safe outputs</p>	<p>Protection IP20 from AS-Interface or 24 V DC (EN 61131-2) max. 2 A S-7.0.E 1...31 Specification 3.0 can be switched off via safety relays</p>	<p>56475</p>
	<p>DI4 - 0.15 A DO4 - 2 A (AB) K3 Sensor supply US Switching current per output Profile (IO/ID/ID2 code) Address range AB-Slave passive safe outputs</p>	<p>Protection IP20 from AS-Interface or 24 V DC (EN 61131-2) max. 2 A S-7.A.7 1...62 (1...31 A or B) Specification 3.0 can be switched off via safety relays</p>	<p>56476</p>
	<p>Digital inputs/relay outputs DI4 - 0.15 A DO4R - 2A Sensor supply US Switching current per output Relay outputs Profile (IO/ID/ID2 code) Address range Standard-Slave</p>	<p>Protection IP20 from AS-Interface or 24 V DC (EN 61131-2) 2 A - S-7.0.E 1...31 Specification 3.0</p>	<p>56477</p>
	<p>DI4 - 0.15 A DO4R - 2A (AB) Sensor supply US Switching current per output Relay outputs Profile (IO/ID/ID2 code) Address range AB-Slave</p>	<p>Protection IP20 from AS-Interface or 24 V DC (EN 61131-2) 2 A - S-7.A.7 1...62 (1...31 A or B) Specification 3.0</p>	<p>56478</p>

MASI CONTROL CABINET

Power Supply Units			Art-No.
	<p>Switch mode power supplies Single-phase, primary switched Input voltage Output voltage Efficiency Output current</p>	<p>Protection IP20 95..265 V AC 30.5 V DC (SELV), ±2% 83% (110 V AC); 85% (240 V AC) max. 4.0 A (+40 °C); 3.4 A (+55 °C)</p>	<p>85381</p>
	<p>Switch mode power supplies Single-phase, primary switched Input voltage Output voltage with EFD (earth fault detection) Efficiency Output current</p>	<p>Protection IP20 95..265 V AC 30.5 V DC (SELV), ±2% - 83% (110 V AC); 85% (240 V AC) max. 4.0 A (+40 °C); 3.4 A (+55 °C)</p>	<p>85382</p>
	<p>Switch mode power supplies 3-phase, primary switched Input voltage Output voltage Efficiency Output current</p>	<p>Protection IP20 3×324..572 V AC/2×340..572 V AC/450..745 V DC 30.5 V DC (SELV), ±1%; 30..32 V adjustable 92.5% (3 × 400 V AC); 91.8% (3 × 480 V AC) 4.8 A (45 °C); 4.0 A (60 °C); 2.9 A (70 °C)</p>	<p>85383</p>



MASI FOR FIELD INSTALLATION

- Flexible use
- Quick installation
- Efficient technology

APPLICATION VARIETY – FOR EFFICIENT AND DECENTRALIZED INSTALLATION

MASI, the AS-Interface product series by Murrelektronik, is the simple solution for cost-efficient integration of I/O signals from machine tools or storage and logistics systems to superordinate control systems. MASI allows the user to build highly flexible I/O systems without being tied to rigid topologies.

Who wants to wire control cabinets or set up complex bus solutions when this can be also done in a more simple, flexible, efficient, and robust way? The MASI I/O system allows you to install all the components at the place where they are needed. This allows a clearly arranged wiring and reduces the installation effort to a minimum.



➤ MASI

I/O modules, accessories and accompanying information material regarding MASI can be found in the **online shop:**

➤ shop.murrelektronik.com

MASI65



Valve plug (form A)

- M12
- Degree of protection IP67

Page 4.9.1

MASI67



I/O modules

- Digital inputs
- Digital inputs/outputs
- Degree of protection IP67

Page 4.9.1

MASI68



I/O modules

- Digital inputs
- Digital inputs/outputs
- Analog outputs
- Analog inputs
- Degree of protection IP67

Page 4.9.3

MASI65			Art-No.
	Digital inputs/outputs DO1 - 2A, DO1 - 2 A, DI2 Sensor supply US Switching current per output Valve Plug (Form A), M12, M12 Profile (IO/ID/ID2 code) Address range Standard-Slave	Protection IP67 max. 200 mA (AS-Interface) max. 2 A - S-3.FE 1...31 Specification 2.1	55680
	Digital outputs DO1 - 2A, DO1 - 2 A Switching current per output Standard-Slave Valve Plug (Form A), M12 Profile (IO/ID/ID2 code) Address range	Protection IP67 max. 2 A Specification 2.1 - S-3.FE 1...31	55681
	DO1 - 2A Switching current per output Standard-Slave Valve plug (form A) Profile (IO/ID/ID2 code) Address range	Protection IP67 max. 2 A Specification 2.1 - S-3.FE 1...31	55682
	Digital inputs/outputs DO1 - 2A, DO1 - 2 A, DI2 Sensor supply US Switching current per output Ventilstecker (Form B), M12, M12 Profile (IO/ID/ID2 code) Address range Standard-Slave	Protection IP67 max. 200 mA (AS-Interface) max. 2 A - S-3.FE 1...31 Specification 2.1	55613
	Digital outputs DO1 - 2A Switching current per output Standard-Slave Valve plug (form B) Profile (IO/ID/ID2 code) Address range	Protection IP67 max. 2 A Specification 2.1 - S-3.FE 1...31	55614
MASI67			Art-No.
	Digital inputs DI4 - 0.2 A (AB) 4xM8 Sensor supply US AB-Slave Profile (IO/ID/ID2 code) Address range	Protection IP67 max. 170 mA (AS-Interface) Specification 3.0 S-0.A.0 1...62 (1...31 A or B)	56405

MASI FIELD INSTALLATION

MASI67			Art-No.
	<p>Digital inputs DI8 - 0.24 A (AB) 8×M8 Sensor supply US AB-Slave Profile (IO/ID/ID2 code) Address range</p>	<p>Protection IP67 max. 180 mA (AS-Interface) Specification 3.0 2 × S-0.A.0 1...62 (2 × 1...31 A or B)</p>	<p>56406</p>
	<p>Digital inputs/outputs DI4 - 0.2 A DO4 - 0.5 A 8×M8 Sensor supply US Standard-Slave Profile (IO/ID/ID2 code) Address range</p>	<p>Protection IP67 max. 180 mA (AS-Interface) Specification 3.0 S-7.0.E 1...31</p>	<p>56408</p>
	<p>Digital inputs DI4 - 0.2 A (AB) 4×M12 Sensor supply US AB-Slave Configuration Profile (IO/ID/ID2 code) Address range</p>	<p>Protection IP67 max. 170 mA (AS-Interface) Specification 3.0 PIN 2 = 4 S-0.A.0 1...62 (1...31 A or B)</p>	<p>56400</p>
	<p>DI4 - 0.2 A (AB) 4×M12 Sensor supply US AB-Slave Configuration Profile (IO/ID/ID2 code) Address range</p>	<p>Protection IP67 max. 170 mA (AS-Interface) Specification 3.0 Y-wiring S-0.A.2 1...62 (1...31 A or B)</p>	<p>56413</p>
	<p>DI8 - 0.24 A (AB) 4×M12 Sensor supply US AB-Slave Configuration Profile (IO/ID/ID2 code) Address range</p>	<p>Protection IP67 max. 180 mA (AS-Interface) Specification 3.0 PIN 2 + 4 2 × S-0.A.2 1...62 (2 × 1...31 A or B)</p>	<p>56401</p>
	<p>Digital inputs/outputs DI4 - 1.6 A DO4 - 2 A 4×M12 Sensor supply US Switching current per output Configuration Profile (IO/ID/ID2 code) Address range Standard-Slave</p>	<p>Protection IP67 max. 1.6 A external max. 2 A PIN 2 + 4 S-7.FE 1...31 Specification 3.0</p>	<p>56404</p>
	<p>DI4 - 0.2 A DO4 - 1.6 A (C) 4×M12 (AB) K3 Sensor supply US Switching current per output Configuration Profile (IO/ID/ID2 code) Address range AB-Slave passive safe outputs</p>	<p>Protection IP67 max. 200 mA (AS-Interface) max. 1.6 A PIN 2 + 4 S-7.A.7 1...62 (1...31 A or B) Specification 3.0 can be switched off via safety relays</p>	<p>56414</p>

MASI FIELD INSTALLATION

MASI67			Art-No.
	Digital inputs/outputs DI8 - 0.34 A DO8 - 1.6 A (AB) 8×M12 (K3) Sensor supply US Switching current per output Configuration Profile (IO/ID/ID2 code) Address range AB-Slave passive safe outputs	Protection IP67 max. 340 mA (AS-Interface) max. 1.6 A PIN 2 + 4 2 × S-7.A.7 1...62 (2 × 1...31 A or B) Specification 3.0 can be switched off via safety relays	56415
	Digital outputs DO8 - 1.6 A (AB) 8×M12 (K3) Safety Switching current per output passive safe outputs Configuration Profile (IO/ID/ID2 code) Address range AB-Slave	Protection IP67 max. 1.6 A can be switched off via safety relays Y-wiring S-7.A.7 1...62 (1...31 A or B) Specification 3.0	56445
MASI68			Art-No.
	Digital inputs DI4 - 0.18 A (C) 4×M8 (AB) Sensor supply US AB-Slave Compact module Profile (IO/ID/ID2 code) Address range	Protection IP68 max. 180 mA (AS-Interface) Specification 3.0 - S-0.A.2 1...62 (1...31 A or B)	56434
	DI4 - 0.18 A (C) 4×M8 Sensor supply US Standard-Slave Compact module Profile (IO/ID/ID2 code) Address range	Protection IP68 max. 180 mA (AS-Interface) Specification 3.0 - S-0.0.0 1...31	56435
	Digital inputs/outputs DI2 - 0.1 A DO2 - 0.5 A (C) 4×M8 (AB) Sensor supply US Switching current per output Compact module Profile (IO/ID/ID2 code) Address range AB-Slave	Protection IP68 max. 100 mA (AS-Interface) max. 0.5 A - S-7.A.E 1...62 (1...31 A or B) Specification 3.0	56446



MASI FIELD INSTALLATION

MASI68			Art-No.
	Digital inputs DI8 - 0.2 A (C) 8×M8 (AB) Sensor supply US AB-Slave Compact module Profile (IO/ID/ID2 code) Address range	Protection IP68 max. 200 mA (AS-Interface) Specification 3.0 - 2 × S-0.A.0 1...62 (2 × 1...31 A or B)	56420
	DI8 - 0.2 A (C) 8×M8 (AB) Sensor supply US AB-Slave Compact module Profile (IO/ID/ID2 code) Address range	Protection IP68 max. 200 mA (AS-Interface) Specification 3.0 Slave 1: 1 A; Slave2: 2 A 2 × S-0.A.0 1...62 (1...31 A or B)	56421
	Digital inputs/outputs DI4 - 0.19 A DO3 - 0.5 A (C) 7×M8 (AB) Sensor supply US Switching current per output Compact module Profile (IO/ID/ID2 code) Address range AB-Slave	Protection IP68 max. 190 mA (AS-Interface) max. 0.5 A - S-7.A.0 1...62 (1...31 A or B) Specification 2.1	56418
	DI4 - 0.19 A DO4 - 0.5 A (C) 8×M8 Sensor supply US Switching current per output Compact module Profile (IO/ID/ID2 code) Address range Standard-Slave	Protection IP68 max. 190 mA (AS-Interface) max. 0.5 A - S-7.0.0 1...31 Specification 3.0	56419
	DI4 - 0.2 A DO4 - 0.5 A (C) 8×M8 (AB) Sensor supply US Switching current per output Compact module Profile (IO/ID/ID2 code) Address range AB-Slave	Protection IP68 max. 190 mA (AS-Interface) max. 0.5 A - S-7.A.7 1...62 (1...31 A or B) Specification 3.0	56462
	Digital inputs DI8 - 0.19 A (E) 8×M8 (AB) Sensor supply US AB-Slave Expansion module Profile (IO/ID/ID2 code) Address range	Protection IP68 max. 190 mA (AS-Interface) Specification 3.0 - 2 × S-0.A.E 1...62 (1...31 A or B)	56436

MASI68			Art-No.
	<p>Digital inputs DI4 - 0.19 A (C) 4×M12 (AB) (Y) Sensor supply US AB-Slave Compact module Profile (IO/ID/ID2 code) Address range</p>	<p>Protection IP68 max. 190 mA (AS-Interface) Specification 3.0 Y-wiring S-0.A.2 1...62 (1...31 A or B)</p>	<p>56421</p>
	<p>DI8 - 0.19 A (C) 4×M12 (AB) Sensor supply US AB-Slave Compact module Profile (IO/ID/ID2 code) Address range</p>	<p>Protection IP68 max. 190 mA (AS-Interface) Specification 3.0 PIN 2 + 4 2 × S-0.A.2 1...62 (2 × 1...31 A or B)</p>	<p>56424</p>
	<p>Digital inputs DI4 - 0.2 A (E) 4×M12 (AB) (Y) Sensor supply US AB-Slave Expansion module Profile (IO/ID/ID2 code) Address range</p>	<p>Protection IP68 max. 200 mA (AS-Interface) Specification 3.0 Y-wiring S-0.A.2 1...62 (1...31 A or B)</p>	<p>56425</p>
	<p>DI4 - 0.19 A (E) 4×M12 (AB) (Y) AUX Sensor supply US AB-Slave Expansion module Profile (IO/ID/ID2 code) Address range</p>	<p>Protection IP68 max. 190 mA (AUX Power) Specification 3.0 Y-wiring S-0.A.2 1...62 (1...31 A or B)</p>	<p>56443</p>
	<p>DI8 - 0.19 A (E) 4×M12 (AB) Sensor supply US AB-Slave Expansion module Profile (IO/ID/ID2 code) Address range</p>	<p>Protection IP68 max. 190 mA (AS-Interface) Specification 3.0 PIN 2 + 4 2 × S-0.A.2 1...62 (2 × 1...31 A or B)</p>	<p>56426</p>
	<p>DI8 - 0.19 A (E) 4×M12 (AB) AUX Sensor supply US AB-Slave Expansion module Profile (IO/ID/ID2 code) Address range</p>	<p>Protection IP68 max. 190 mA (AUX Power) Specification 3.0 PIN 2 + 4 2 × S-0.A.2 1...62 (2 × 1...31 A or B)</p>	<p>56444</p>
	<p>Digital inputs/outputs DI4 - 0.19 A DO4 - 1 A (E) 4×M12 (AB) Sensor supply US Switching current per output Expansion module Profile (IO/ID/ID2 code) Address range AB-Slave</p>	<p>Protection IP68 max. 190 mA (AS-Interface) max. 1 A PIN 2 + 4 S-7.A.7 1...62 (1...31 A or B) Specification 3.0</p>	<p>56439</p>

MASI FIELD INSTALLATION

MASI68			Art-No.
	<p>Digital outputs</p> <p>DO8 - 0.5 A (AB) 4xM12 (K3) Switching current per output passive safe outputs Expansion module Profile (IO/ID/ID2 code) Address range AB-Slave</p>	<p>Protection IP68 max. 0.5 A can be switched off via safety relays PIN 2 + 4 S-7.A.7 1...62 (1...31 A or B) Specification 3.0</p>	56447
	<p>Digital inputs/outputs</p> <p>DI4 - 0.19 A DO4 - 2 A (C) 8xM12 (Y) Sensor supply US Switching current per output Compact module Profile (IO/ID/ID2 code) Address range Standard-Slave</p>	<p>Protection IP68 max. 190 mA (AS-Interface) max. 2 A Y-wiring S-7.FE 1...31 Specification 3.0</p>	56422
	<p>DI4 - 0.19 A DO4 - 2 A (C) 8xM12 Sensor supply US Switching current per output Compact module Profile (IO/ID/ID2 code) Address range Standard-Slave</p>	<p>Protection IP68 max. 190 mA (AS-Interface) max. 2 A PIN 4 S-7.0.7 1...31 Specification 3.0</p>	56438
	<p>DI4 - 0.2 A DO4 - 1.6 A (C) 8xM12 (AB) (Y) (K3) Sensor supply US Switching current per output Compact module Profile (IO/ID/ID2 code) Address range AB-Slave passive safe outputs</p>	<p>Protection IP68 max. 200 mA (AS-Interface) max. 1.6 A Y-wiring S-7.A.7 1...62 (1...31 A or B) Specification 3.0 can be switched off via safety relays</p>	56423
	<p>Digital inputs/outputs</p> <p>DI4 - 0.2 A DO4 - 2 A (E) 8xM12 (Y) Sensor supply US Switching current per output Expansion module Profile (IO/ID/ID2 code) Address range Standard-Slave</p>	<p>Protection IP68 max. 200 mA (AS-Interface) max. 2 A Y-wiring S-7.FE 1...31 Specification 3.0</p>	56427
	<p>Digital inputs/outputs</p> <p>DI4 - 0.2 A DO4 - 1.6 A (E) 8xM12 (AB) (Y) (K3) Sensor supply US Switching current per output Expansion module Profile (IO/ID/ID2 code) Address range AB-Slave passive safe outputs</p>	<p>Protection IP68 max. 200 mA (AS-Interface) max. 1.6 A Y-wiring S-7.A.7 1...62 (1...31 A or B) Specification 3.0 can be switched off via safety relays</p>	56428

MASI68			Art-No.
	<p>Analog inputs AI4 - (E) RTD Measuring current Standard-Slave Expansion module Profile (IO/ID/ID2 code) Address range</p>	<p>Protection IP68 Pt100 - 1.25 mA Specification 3.0 - S-7.3.E 1...31</p>	<p>56442</p>
	<p>AI4 - (E) 4×M12 (UI) Input range (current) Input range (voltage) Expansion module Profile (IO/ID/ID2 code) Address range Standard-Slave</p>	<p>Protection IP68 -22...22 mA -10...+10 V - S-7.3.E 1...31 Specification 3.0</p>	<p>56448</p>
	<p>Analog outputs AO2 - (E) 2×M12 (UI) Output current Output voltage Expansion module Profile (IO/ID/ID2 code) Address range Standard-Slave</p>	<p>Protection IP68 0...22 mA -10...+10 V - S-7.3.5 1...31 Specification 3.0</p>	<p>56474</p>

MASI INSTALLATION TECHNOLOGY

- Versatile
- Leak-proof for industrial use
- Simplest installation

AS-INTERFACE SYSTEM

In connection with the installation technology, the AS-Interface system from Murrelektronik provides consistent solutions from the operating panel through the control cabinet to the field - from IP00 to IP68.

Due to the application-oriented optimization of the modules, a safe installation and extension of the system can be realized very easily.

- **Easy** – Connection using the cable penetration technology, plug-in connectors or M12
- **Consistent** – products adapted to the fields of application from IP00 to IP68
- **Up-to-date** – latest technology according to the AS-interface specification 3.0



➤ MASI

I/O modules, accessories and accompanying information material regarding MASI can be found in the **online shop**:

➤ shop.murrelektronik.com

MASI20/67/68



- Distributor
- Converter
- Adapter

Page 4.10.1

System/Torque wrenches



- Programming device
- Z-plug
- T-coupler
- Mounting plates

Page 4.10.3



- Torque wrench M8
- Torque wrench M12
- Torque wrench 7/8"

Page 4.10.3

Cables



- Profile cables
- Coding elements
- Adapter, terminals

Page 4.10.4



- Round plug connector
- T-coupler
- DIN-rail adapter
- Connecting cables

Page 4.10.6











MASI20			Art-No.
	Bus or Power distributor 2 AS-Interface + 3 power ports potentially separated	5 plug terminals included	55575
	3 AS-Interface + 2 power ports potentially separated	5 plug terminals included	55606
	Bus or Power distributor 1 × 3 AS-Interface + 2 × 1 power ports 5 ports, universal potentially separated	5 plug terminals included	55605
	1 × 5 AS-Interface/power ports 5 ports, universal not potentially separated	5 plug terminals included	55611
	Bus or Power distributor 1 × 3 AS-Interface + 2 × 1 power ports 5 ports, universal potentially separated	without plug terminals	55607
	Plug terminal for bus or power distributor	AS-Interface profile cable	55604
MASI67			Art-No.
	MASI67 connection 2 × on 2 × profile cable Total current: max. 8 A		55033
	1 × on 3 × profile cable Total current: max. 8 A		55034
	MASI67 converter 2 × profile cable to 7/8" (female) Total current: max. 8 A	5-pole	55035
	MASI67 converter 2 × profile cable to 7/8" (male) Total current: max. 8 A	5-pole	55036
	MASI67 converter 2 × profile cable to M12 (female) Total current: max. 4 A	M12, 4-pole, A-coded	55037

MASI INSTALLATION TECHNOLOGY

MASI67			Art-No.
	MASI67 converter 2 × profile cable to M12 (male) Total current: max. 4 A	M12, 4-pole, A-coded	55038
	AS-Interface distributor from profile to profile cable Operating current: max. 3 A		55749
	AS-Interface breakout from profile cable to M12 Operating current: max. 2 A	M12, 2-pole, A-coded	55741
MASI67/68			Art-No.
	MASI67 passive distribution box 2 × profile cable to 4 × M12 (female) Current (M12): max. 4 A Total current: max. 8 A Ext. supply: 1 × aux power	M12, 4-pole, A-coded	56412
	2 × profile cable to 4 × M12 (female) Current (M12): max. 4 A Total current: max. 2 × 8 A Ext. supply: 2 × separately aux power	M12, 4-pole, A-coded	56416
MASI68			Art-No.
	MASI68 passive distribution box 1×7/8 AUX + 1×M12 AS-Interface to 3×M12 (female) Current (M12): max. 4 A Total current: max. 2 × 8 A	M12, 4-pole, A-coded 2 separate circuits	56454
	T-coupler (SlimLine) M12 - M12 Male straight - female straight Parallel circuit	5-pole	7000-41151-0000000
	T-coupler M12 - M12 Male straight - female straight Parallel circuit	5-pole	7000-41141-0000000
	Holding plate for T-couplers M12 (SlimLine) for T-couplers M12 (SlimLine)	without mounting set with mounting set	7000-99061-0000000 7000-99062-0000000

System			Art-No.
	Programming device AS-Interface programming device	AS-Interface addressing cable	55696
	Addressing cable Spare cable	for AS-Interface programming device	55727
	MASI Z-Plug Passive bus terminator		55779
	T-coupler (SlimLine) M12 - M12 Male straight - female straight Distribution function (NO)	5-pole - 4-pole	7000-41131-0000000
	T-coupler M12 - M12 Male straight - female straight Distribution function (NO)	5-pole - 4-pole	7000-41121-0000000
	Holding plate for T-couplers M12 (SlimLine)	without mounting set	7000-99061-0000000
	for T-couplers M12 (SlimLine)	with mounting set	7000-99062-0000000
Torque wrench			Art-No.
	Torque wrench set M12 (0.6 Nm, SW13)	M12 data connector molded (standard)	7000-99102-0000000
	Torque wrench M12 (0.6 Nm, SW13) M12 (0.6 Nm, SW14)	M12 data connector molded (standard)	7000-99109-0000000
		M12 data connector moulded (Xtreme)	7000-99108-0000000
	Torque wrench M12 (0.6 Nm, SW17)	M12 field-wireable (IDC terminal)	7000-99094-0000000
	Torque wrench M12 (0.6 Nm, SW18)	M12 field-wireable via (screw terminals)	7000-99103-0000000
	Torque wrench set M8 (0.4 Nm, SW9)	M8 data connectors	7000-99101-0000000

MASI INSTALLATION TECHNOLOGY

Torque wrench			Art-No.
	Torque wrench M8 (0.4 Nm, SW9)	M8 data connectors	7000-99091-000000
	Torque wrench set 7/8" (1.5 Nm, SW22)	7/8" data connenctor moulded (IDC terminal)	7000-99104-000000
	Torque wrench 7/8" (1.5 Nm, SW22) 7/8" (1.5 Nm, SW24)	7/8" data connenctor moulded (IDC terminal) 7700-XXXXX - 7/8" data connenctor moulded (screw terminals)	7000-99096-000000 7000-99097-000000
For profile cable			Art-No.
	Coding element - short for MASI67 AS-i	Quantity: 2 pcs.	55059
	Coding element - long for MASI67 AUX	Quantity: 2 pcs.	55060
	Mounting bracket for AS-Interface profile cable	Quantity: 50 pcs.	55742
	Adapter from profile cable to M16		56453
	Plug terminal for bus or power distributor	AS-Interface profile cable	55604
	AS-Interface distributor from profile to profile cable Operating current: max. 3 A		55749
	AS-Interface breakout from profile cable to M12 Operating current: max. 2 A	M12, 2-pole, A-coded	55741

For profile cable			Art-No.
	Middle gasket for profile cable	Quantity: 2 pcs.	55062
	End gasket for Profile cable left/right	Quantity: 2 pieces right + 2 pieces left	55061
	End gasket for profile cable right	Quantity: 100 pcs.	56432
	End gasket for Profile cable left	Quantity: 100 pcs.	56433
	End gasket for Profile cable left/right	Quantity: 5 pcs. right + 5 pcs. left	55746
	Bulk cable Profile cable yellow, 2 × 1.5 mm ² PUR (UL/CSA), C-tracks	1 m	55743
	Bulk cable Profile cable yellow, 2 × 1.5 mm ² PUR (UL/CSA), C-tracks Profile cable yellow, 2 × 2.5 mm ² PUR (UL/CSA), C-tracks	Cable ring: 100 m Other versions on request.	7000-C9901-1660000 7000-C9901-1780000
	Bulk cable Profile cable black, 2 × 1.5 mm ² PUR (UL/CSA), C-tracks	1 m	55744
	Bulk cable Profile cable black, 2 × 1.5 mm ² PUR (UL/CSA), C-tracks Profile cable black, 2 × 2.5 mm ² PUR (UL/CSA), C-tracks	Cable ring: 100 m Other versions on request.	7000-C9901-7840000 7000-C9901-7790000

MASI INSTALLATION TECHNOLOGY

Round cable MASI68			Art-No.
	T-coupler M12 – M12 Female straight - male/male straight A-coded, 4-pole	MASI68 additional actuator power supply	7060-42701-000000
	Female straight - male/male straight Distribution function (NO) MASI68 additional actuator power supply MVK Metall Safety	4-pole	7060-42703-000000
	DIN-rail adapter for extension modules	30 mm	56963
		DIN-rail adapter for extension modules	50 mm
	Cable drum (100 m) 2 × 1.5 mm ² , gray Suitable for C-tracks	AS-Interface, MASI68	7000-C0201-588000
Round plug connectors MASI68			Art-No.
	Connection cable Male straight - female straight 2 × 1.5 mm ² , gray PUR (UL/CSA) 1.0 m	M12 - M12 2-pole Suitable for C-tracks Other versions on request.	7060-40005-5880100
	Male straight - female straight 4 × 0.75 mm ² , gray PUR (UL/CSA) 1.0 m	M12 - M12 4-pole Suitable for C-tracks Other versions on request.	7060-40021-8620100
	Connection cable Male 90° - female 90° 2 × 1.5 mm ² , gray PUR (UL/CSA) 1.0 m	M12 - M12 2-pole Suitable for C-tracks Other versions on request.	7060-40245-5880100
	Male 90° - female 90° 4 × 0.75 mm ² , gray PUR (UL/CSA) 1.0 m	M12 - M12 4-pole Suitable for C-tracks Other versions on request.	7060-40261-8620100

Round plug connectors MASI68			Art-No.
	Connection cable Male straight - female straight 2 × 1.0 mm ² , gray PUR (UL/CSA) 1.0 m	M12 - M12 2-pole, shielded Suitable for C-tracks Other versions on request.	7060-40485-5420100
	Male straight - female straight 2 × 0.75 mm ² + 2 × 0.75 mm ² , gray PUR (UL/CSA) 1.0 m	M12 - M12 4-pole, shielded Suitable for C-tracks Other versions on request.	7060-40505-4940100
	With open ended wires Female straight 4 × 0.75 mm ² , gray PUR (UL/CSA) 1.0 m	M12 4-pole Suitable for C-tracks Other versions on request.	7060-12221-8620100
Labeling accessories			Art-No.
	Label plates 20 × 8 mm	(20 pieces per plate)	55318
Blind plug/caps			Art-No.
	Screw plug M12 × 1 mm Plastic, hex with gasket	Quantity: 4 pcs.	55468
	Plastic, hex with gasket	Quantity: 100 pcs.	56455
	Plastic, hex without gasket	Quantity: 4 pcs.	56952
	Plastic, hex without gasket	Quantity: 10 pcs.	58627
	Screw plug M8 × 1 mm (for female) Plastic, hex without gasket	Quantity: 10 pcs.	3858627



M8 DISTRIBUTION SYSTEMS EXACT8

- Saves space
- Versatile
- Application oriented

EXACT8 – THE NEW GENERATION OF MURRELEKTRONIK'S M8 DISTRIBUTION BOXES

- Small dimensions (30 mm width)
- PUR/PVC cable for flexible and fixed assembly
- High-quality, halogen-free PUR cable suitable for C-tracks, UL/CSA approved
- Standard or side mounting for limited space
- Quick and easy replacement of connection cables

For Sensors and Actuators – Molded Homerun Cables or Connection Caps

 <p>Exact8</p> <ul style="list-style-type: none"> • 4-, 6-, 8-, 10-way • PUR or PUR/PVC homerun cable <p style="text-align: right;"><i>Page 4.11.1</i></p>	 <p>Exact8 basic modules</p> <ul style="list-style-type: none"> • 4-, 6-, 8-, 10-way <p style="text-align: right;"><i>Page 4.11.5</i></p>
 <p>Exact8 connection caps</p> <ul style="list-style-type: none"> • Pre-wired • PUR or PUR/PVC homerun cable <p style="text-align: right;"><i>Page 4.11.8</i></p>	 <p>Exact8 set</p> <ul style="list-style-type: none"> • 4-, 6-, 8-, 10-way • Field-wireable <p style="text-align: right;"><i>Page 4.11.11</i></p>

For Sensors – with M12 Connection

 <p>Exact8</p> <ul style="list-style-type: none"> • 4-, 6-, 8-, 10-way • With 8- or 12-pole M12 connection <p style="text-align: right;"><i>Page 4.11.12</i></p>

M8 DISTRIBUTION SYSTEMS

For sensors and actuators

– with molded homerun cable

– Inline face or side mounting



Exact8

4-way



Exact8

6-way



Exact8

8-way



Exact8

10-way



1 Form	84010	86010	88010	80010
Type	PNP, 3-pole	PNP, 3-pole	PNP, 3-pole	PNP, 3-pole
Contact layout	M8-Females 3-pole 			
2 Cable Type	Jacket Color – No./diameter of wires			
	gray	gray	gray	gray
PUR/PVC	337 – 4 × 0.34 + 2 × 0.75 mm ²	350 – 6 × 0.34 + 2 × 0.75 mm ²	357 – 8 × 0.34 + 2 × 0.75 mm ²	385 – 10 × 0.34 + 2 × 0.75 mm ²
PUR (UL/CSA), robots/C-tracks	334 – 4 × 0.34 + 2 × 0.75 mm ²	356 – 6 × 0.34 + 2 × 0.75 mm ²	359 – 8 × 0.34 + 2 × 0.75 mm ²	384 – 10 × 0.34 + 2 × 0.75 mm ²
3 Cable Length				
3.0 m	0300			
5.0 m	0500			
10.0 m	1000			
15.0 m	1500			
Technical Data				
Operating voltage	24 V DC			
Total current	max. 8 A			
Protection	IP65/IP67			
Temperature range	-20...+80 °C, depending on cable quality			
Contact Layout				
LED display	LED (green): Power / LED (yellow): (S1)			
PIN 1	(+)			
PIN 3	(-)			
PIN 4	(NO)/(S1)			
Article No.				
The composition of your article number is explained on page 3.1.i	<div style="display: flex; justify-content: space-around; align-items: center;"> 8 0 0 0 - - - - - - </div>			
	1	2	3	
	Form	Cable Type	Cable Length	
Notes				

M8 DISTRIBUTION SYSTEMS

For sensors and actuators

- with molded homerun cable
- Inline face or side mounting



1 Form	84011	86011	88011	80011															
Type	NPN, 3-pole	NPN, 3-pole	NPN, 3-pole	NPN, 3-pole															
Contact layout	M8-Females 3-pole <p>for 1 signal per port</p>																		
2 Cable Type	Jacket Color – No./diameter of wires <table border="1"> <thead> <tr> <th></th> <th>gray</th> <th>gray</th> <th>gray</th> <th>gray</th> </tr> </thead> <tbody> <tr> <td>PUR/PVC</td> <td>337 – 4 × 0.34 + 2 × 0.75 mm²</td> <td>350 – 6 × 0.34 + 2 × 0.75 mm²</td> <td>357 – 8 × 0.34 + 2 × 0.75 mm²</td> <td>385 – 10 × 0.34 + 2 × 0.75 mm²</td> </tr> <tr> <td>PUR (UL/CSA), robots/C-tracks</td> <td>334 – 4 × 0.34 + 2 × 0.75 mm²</td> <td>356 – 6 × 0.34 + 2 × 0.75 mm²</td> <td>359 – 8 × 0.34 + 2 × 0.75 mm²</td> <td>384 – 10 × 0.34 + 2 × 0.75 mm²</td> </tr> </tbody> </table>					gray	gray	gray	gray	PUR/PVC	337 – 4 × 0.34 + 2 × 0.75 mm ²	350 – 6 × 0.34 + 2 × 0.75 mm ²	357 – 8 × 0.34 + 2 × 0.75 mm ²	385 – 10 × 0.34 + 2 × 0.75 mm ²	PUR (UL/CSA), robots/C-tracks	334 – 4 × 0.34 + 2 × 0.75 mm ²	356 – 6 × 0.34 + 2 × 0.75 mm ²	359 – 8 × 0.34 + 2 × 0.75 mm ²	384 – 10 × 0.34 + 2 × 0.75 mm ²
	gray	gray	gray	gray															
PUR/PVC	337 – 4 × 0.34 + 2 × 0.75 mm ²	350 – 6 × 0.34 + 2 × 0.75 mm ²	357 – 8 × 0.34 + 2 × 0.75 mm ²	385 – 10 × 0.34 + 2 × 0.75 mm ²															
PUR (UL/CSA), robots/C-tracks	334 – 4 × 0.34 + 2 × 0.75 mm ²	356 – 6 × 0.34 + 2 × 0.75 mm ²	359 – 8 × 0.34 + 2 × 0.75 mm ²	384 – 10 × 0.34 + 2 × 0.75 mm ²															
3 Cable Length	<table border="1"> <tbody> <tr> <td>5.0 m</td> <td>0500</td> </tr> <tr> <td>10.0 m</td> <td>1000</td> </tr> </tbody> </table>				5.0 m	0500	10.0 m	1000											
5.0 m	0500																		
10.0 m	1000																		
Technical Data	<table border="1"> <tbody> <tr> <td>Operating voltage</td> <td>24 V DC</td> </tr> <tr> <td>Total current</td> <td>max. 8 A</td> </tr> <tr> <td>Protection</td> <td>IP65/IP67</td> </tr> <tr> <td>Temperature range</td> <td>-20...+80 °C, depending on cable quality</td> </tr> </tbody> </table>				Operating voltage	24 V DC	Total current	max. 8 A	Protection	IP65/IP67	Temperature range	-20...+80 °C, depending on cable quality							
Operating voltage	24 V DC																		
Total current	max. 8 A																		
Protection	IP65/IP67																		
Temperature range	-20...+80 °C, depending on cable quality																		
Contact Layout	<table border="1"> <tbody> <tr> <td>LED display</td> <td>LED (green): Power / LED (yellow): (S1)</td> </tr> <tr> <td>PIN 1</td> <td>(+)</td> </tr> <tr> <td>PIN 3</td> <td>(-)</td> </tr> <tr> <td>PIN 4</td> <td>(NO)/(S1)</td> </tr> </tbody> </table>				LED display	LED (green): Power / LED (yellow): (S1)	PIN 1	(+)	PIN 3	(-)	PIN 4	(NO)/(S1)							
LED display	LED (green): Power / LED (yellow): (S1)																		
PIN 1	(+)																		
PIN 3	(-)																		
PIN 4	(NO)/(S1)																		
Article No.	<table border="1"> <tbody> <tr> <td>The composition of your article number is explained on page 3.1.i</td> <td><u>8</u> <u>0</u> <u>0</u> <u>0</u></td> <td>-</td> <td>-</td> <td>-</td> </tr> <tr> <td></td> <td>1 Form</td> <td>2 Cable Type</td> <td>3 Cable Length</td> <td></td> </tr> </tbody> </table>				The composition of your article number is explained on page 3.1.i	<u>8</u> <u>0</u> <u>0</u> <u>0</u>	-	-	-		1 Form	2 Cable Type	3 Cable Length						
The composition of your article number is explained on page 3.1.i	<u>8</u> <u>0</u> <u>0</u> <u>0</u>	-	-	-															
	1 Form	2 Cable Type	3 Cable Length																
Notes																			

M8 Distribution Systems

M8 DISTRIBUTION SYSTEMS

- For sensors and actuators
- with molded homerun cable
- Inline face or side mounting



1 Form	84110	86110	88110	80110															
Type	PNP, 4-pole	PNP, 4-pole	PNP, 4-pole	PNP, 4-pole															
Contact layout	<p>M8-Females 4-pole</p> <p>4 (S1) 2 (S2) 3 (-) 1 (+)</p> <p>for 2 signals per port</p>																		
2 Cable Type	<p>Jacket Color – No./diameter of wires</p> <table border="1"> <thead> <tr> <th></th> <th>gray</th> <th>gray</th> <th>gray</th> <th>gray</th> </tr> </thead> <tbody> <tr> <td>PUR/PVC</td> <td>358 – 8 × 0.34 + 2 × 0.75 mm²</td> <td>386 – 12 × 0.34 + 2 × 0.75 mm²</td> <td>395 – 16 × 0.34 + 2 × 0.75 mm²</td> <td>412 – 20 × 0.34 + 2 × 0.75 mm²</td> </tr> <tr> <td>PUR (UL/CSA), robots/C-tracks</td> <td>360 – 8 × 0.34 + 2 × 0.75 mm²</td> <td>389 – 12 × 0.34 + 2 × 0.75 mm²</td> <td>396 – 16 × 0.34 + 2 × 0.75 mm²</td> <td>411 – 20 × 0.34 + 2 × 0.75 mm²</td> </tr> </tbody> </table>					gray	gray	gray	gray	PUR/PVC	358 – 8 × 0.34 + 2 × 0.75 mm ²	386 – 12 × 0.34 + 2 × 0.75 mm ²	395 – 16 × 0.34 + 2 × 0.75 mm ²	412 – 20 × 0.34 + 2 × 0.75 mm ²	PUR (UL/CSA), robots/C-tracks	360 – 8 × 0.34 + 2 × 0.75 mm ²	389 – 12 × 0.34 + 2 × 0.75 mm ²	396 – 16 × 0.34 + 2 × 0.75 mm ²	411 – 20 × 0.34 + 2 × 0.75 mm ²
	gray	gray	gray	gray															
PUR/PVC	358 – 8 × 0.34 + 2 × 0.75 mm ²	386 – 12 × 0.34 + 2 × 0.75 mm ²	395 – 16 × 0.34 + 2 × 0.75 mm ²	412 – 20 × 0.34 + 2 × 0.75 mm ²															
PUR (UL/CSA), robots/C-tracks	360 – 8 × 0.34 + 2 × 0.75 mm ²	389 – 12 × 0.34 + 2 × 0.75 mm ²	396 – 16 × 0.34 + 2 × 0.75 mm ²	411 – 20 × 0.34 + 2 × 0.75 mm ²															
3 Cable Length	<table border="1"> <tbody> <tr> <td>3.0 m</td> <td>0300</td> </tr> <tr> <td>5.0 m</td> <td>0500</td> </tr> <tr> <td>10.0 m</td> <td>1000</td> </tr> <tr> <td>15.0 m</td> <td>1500</td> </tr> </tbody> </table>				3.0 m	0300	5.0 m	0500	10.0 m	1000	15.0 m	1500							
3.0 m	0300																		
5.0 m	0500																		
10.0 m	1000																		
15.0 m	1500																		
Technical Data	<table border="1"> <tbody> <tr> <td>Operating voltage</td> <td>24 V DC</td> </tr> <tr> <td>Total current</td> <td>max. 8 A</td> </tr> <tr> <td>Protection</td> <td>IP65/IP67</td> </tr> <tr> <td>Temperature range</td> <td>-20...+80 °C, depending on cable quality</td> </tr> </tbody> </table>				Operating voltage	24 V DC	Total current	max. 8 A	Protection	IP65/IP67	Temperature range	-20...+80 °C, depending on cable quality							
Operating voltage	24 V DC																		
Total current	max. 8 A																		
Protection	IP65/IP67																		
Temperature range	-20...+80 °C, depending on cable quality																		
Contact Layout	<table border="1"> <tbody> <tr> <td>LED display</td> <td>LED (green): Power / LED (yellow): (S1) / LED (white): Signal (S2)</td> </tr> <tr> <td>PIN 1</td> <td>(+)</td> </tr> <tr> <td>PIN 2</td> <td>(NC)/(S2)</td> </tr> <tr> <td>PIN 3</td> <td>(-)</td> </tr> <tr> <td>PIN 4</td> <td>(NO)/(S1)</td> </tr> </tbody> </table>				LED display	LED (green): Power / LED (yellow): (S1) / LED (white): Signal (S2)	PIN 1	(+)	PIN 2	(NC)/(S2)	PIN 3	(-)	PIN 4	(NO)/(S1)					
LED display	LED (green): Power / LED (yellow): (S1) / LED (white): Signal (S2)																		
PIN 1	(+)																		
PIN 2	(NC)/(S2)																		
PIN 3	(-)																		
PIN 4	(NO)/(S1)																		
Article No.	<p>The composition of your article number is explained on page 3.1.i</p> <p>8 0 0 0 – _____ – _____</p>																		
Notes	<p>1 Form 2 Cable Type 3 Cable Length</p>																		

M8 DISTRIBUTION SYSTEMS

For sensors and actuators

- with molded homerun cable
- Inline face or side mounting



1 Form	84111	86111	88111	80111														
Type	NPN, 4-pole	NPN, 4-pole	NPN, 4-pole	NPN, 4-pole														
Contact layout	M8-Females 4-pole 4 (S1) 2 (S2) 3 (-) 1 (+) for 2 signals per port 																	
2 Cable Type	Jacket Color – No./diameter of wires <table border="1"> <thead> <tr> <th>gray</th> <th>gray</th> <th>gray</th> <th>gray</th> </tr> </thead> <tbody> <tr> <td>PUR/PVC</td> <td>358 – 8 × 0.34 + 2 × 0.75 mm²</td> <td>386 – 12 × 0.34 + 2 × 0.75 mm²</td> <td>395 – 16 × 0.34 + 2 × 0.75 mm²</td> <td>412 – 20 × 0.34 + 2 × 0.75 mm²</td> </tr> <tr> <td>PUR (UL/CSA), robots/C-tracks</td> <td>360 – 8 × 0.34 + 2 × 0.75 mm²</td> <td>389 – 12 × 0.34 + 2 × 0.75 mm²</td> <td>396 – 16 × 0.34 + 2 × 0.75 mm²</td> <td>411 – 20 × 0.34 + 2 × 0.75 mm²</td> </tr> </tbody> </table>				gray	gray	gray	gray	PUR/PVC	358 – 8 × 0.34 + 2 × 0.75 mm ²	386 – 12 × 0.34 + 2 × 0.75 mm ²	395 – 16 × 0.34 + 2 × 0.75 mm ²	412 – 20 × 0.34 + 2 × 0.75 mm ²	PUR (UL/CSA), robots/C-tracks	360 – 8 × 0.34 + 2 × 0.75 mm ²	389 – 12 × 0.34 + 2 × 0.75 mm ²	396 – 16 × 0.34 + 2 × 0.75 mm ²	411 – 20 × 0.34 + 2 × 0.75 mm ²
gray	gray	gray	gray															
PUR/PVC	358 – 8 × 0.34 + 2 × 0.75 mm ²	386 – 12 × 0.34 + 2 × 0.75 mm ²	395 – 16 × 0.34 + 2 × 0.75 mm ²	412 – 20 × 0.34 + 2 × 0.75 mm ²														
PUR (UL/CSA), robots/C-tracks	360 – 8 × 0.34 + 2 × 0.75 mm ²	389 – 12 × 0.34 + 2 × 0.75 mm ²	396 – 16 × 0.34 + 2 × 0.75 mm ²	411 – 20 × 0.34 + 2 × 0.75 mm ²														
3 Cable Length	<table border="1"> <tbody> <tr> <td>5.0 m</td> <td>0500</td> </tr> <tr> <td>10.0 m</td> <td>1000</td> </tr> </tbody> </table>				5.0 m	0500	10.0 m	1000										
5.0 m	0500																	
10.0 m	1000																	
Technical Data	<table border="1"> <tbody> <tr> <td>Operating voltage</td> <td>24 V DC</td> </tr> <tr> <td>Total current</td> <td>max. 8 A</td> </tr> <tr> <td>Protection</td> <td>IP65/IP67</td> </tr> <tr> <td>Temperature range</td> <td>-20...+80 °C, depending on cable quality</td> </tr> </tbody> </table>				Operating voltage	24 V DC	Total current	max. 8 A	Protection	IP65/IP67	Temperature range	-20...+80 °C, depending on cable quality						
Operating voltage	24 V DC																	
Total current	max. 8 A																	
Protection	IP65/IP67																	
Temperature range	-20...+80 °C, depending on cable quality																	
Contact Layout	<table border="1"> <tbody> <tr> <td>LED display</td> <td>LED (green): Power / LED (yellow): (S1) / LED (white): Signal (S2)</td> </tr> <tr> <td>PIN 1</td> <td>(+)</td> </tr> <tr> <td>PIN 2</td> <td>(NC)/(S2)</td> </tr> <tr> <td>PIN 3</td> <td>(-)</td> </tr> <tr> <td>PIN 4</td> <td>(NO)/(S1)</td> </tr> </tbody> </table>				LED display	LED (green): Power / LED (yellow): (S1) / LED (white): Signal (S2)	PIN 1	(+)	PIN 2	(NC)/(S2)	PIN 3	(-)	PIN 4	(NO)/(S1)				
LED display	LED (green): Power / LED (yellow): (S1) / LED (white): Signal (S2)																	
PIN 1	(+)																	
PIN 2	(NC)/(S2)																	
PIN 3	(-)																	
PIN 4	(NO)/(S1)																	
Article No.	<table border="1"> <tbody> <tr> <td>The composition of your article number is explained on page 3.1.i</td> <td>8 0 0 0</td> <td>-</td> <td>-</td> <td>-</td> </tr> </tbody> </table>				The composition of your article number is explained on page 3.1.i	8 0 0 0	-	-	-									
The composition of your article number is explained on page 3.1.i	8 0 0 0	-	-	-														
	1 Form	2 Cable Type	3 Cable Length															
Notes																		

M8 DISTRIBUTION SYSTEMS

For sensors and actuators

– Base modules

– Inline face or side mounting

Exact8

4-way



Exact8

6-way



Exact8

8-way



Exact8

10-way



Approvals: UL_{us}
Listed

1 Form	84000	86000	88000	80000
Type	PNP, 3-pole	PNP, 3-pole	PNP, 3-pole	PNP, 3-pole
Contact layout	<p>M8-Females 3-pole</p> <p>for 1 signal per port</p>			
Technical Data				
Operating voltage	24 V DC			
Operating current per contact	max. 2 A			
Total current	max. 8 A			
Protection	IP65/IP67			
Temperature range	-20...+70 °C, depending on cable quality			
Contact Layout				
LED display	LED (green): Power / LED (yellow): (S1)			
PIN 1	(+)			
PIN 3	(-)			
PIN 4	(NO)/(S1)			
Article No.				
The composition of your article number is explained on page 3.1.i	<u>8</u> <u>0</u> <u>0</u> <u>0</u>	-	<u>0</u> <u>0</u> <u>0</u>	<u>0</u> <u>0</u> <u>0</u> <u>0</u>
	1 Form			
Notes				

M8 DISTRIBUTION SYSTEMS

For sensors and actuators

- Base modules
- Inline face or side mounting

Approvals:  Listed

Exact8
4-way



Exact8
6-way



Exact8
8-way



Exact8
10-way



1 Form	84001	86001	88001	80001
Type	NPN, 3-pole	NPN, 3-pole	NPN, 3-pole	NPN, 3-pole
Contact layout	<p>M8-Females 3-pole</p> <p>for 1 signal per port</p>			
Technical Data				
Operating voltage	24 V DC			
Operating current per contact	max. 2 A			
Total current	max. 8 A			
Protection	IP65/IP67			
Temperature range	-20...+70 °C, depending on cable quality			
Contact Layout				
LED display	LED (green): Power / LED (yellow): (S1)			
PIN 1	(+)			
PIN 3	(-)			
PIN 4	(NO)/(S1)			
Article No.				
The composition of your article number is explained on page 3.1.i	<div style="display: flex; justify-content: space-around; align-items: center;"> <u>8 0 0 0</u> - _____ - <u>0 0 0</u> <u>0 0 0 0</u> </div>			
	1 Form			
Notes				

M8 DISTRIBUTION SYSTEMS

For sensors and actuators

– Base modules

– Inline face or side mounting



Exact8

4-way



Exact8

6-way



Exact8

8-way



1 Form	84100	86100	88100
Type	PNP, 4-pole	PNP, 4-pole	PNP, 4-pole
Contact layout	<p>M8 Females 4-pole</p> <p>4 (S1) 2 (S2) 3 (-) 1 (+)</p> <p>for 2 signals per port</p>	<p>M8-Females 4-pole</p> <p>4 (S1) 2 (S2) 3 (-) 1 (+)</p> <p>for 2 signals per port</p>	
Technical Data	<p>Operating voltage 24 V DC</p> <p>Operating current per contact max. 2 A</p> <p>Total current max. 8 A</p> <p>Protection IP65/IP67</p> <p>Temperature range -20...+70 °C, depending on cable quality</p>		
Contact Layout	<p>LED display LED (green): Power / LED (yellow): (S1) / LED (white): Signal (S2)</p> <p>PIN 1 (+)</p> <p>PIN 2 (NC)/(S2)</p> <p>PIN 3 (-)</p> <p>PIN 4 (NO)/(S1)</p>		
Article No.			
The composition of your article number is explained on page 3.1.i	<u>8</u> <u>0</u> <u>0</u> <u>0</u>	-	<u>0</u> <u>0</u> <u>0</u>
	1 Form		<u>0</u> <u>0</u> <u>0</u> <u>0</u>
Notes			

M8 DISTRIBUTION SYSTEMS

For sensors and actuators

– Connection cap with homerun cable

Approvals:  Listed

Exact8

Connection cap short

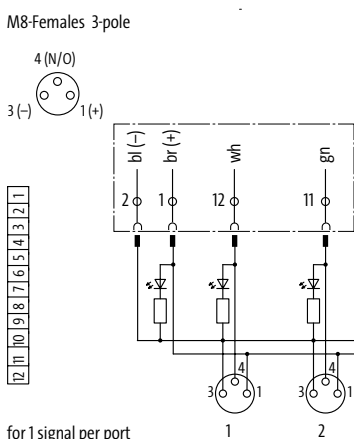

1 Form	84049	86049	88049	80049
Type	for 4-way distribution box, 3-pole Spring clamp plug-in terminals	for 6-way distribution box, 3-pole Spring clamp plug-in terminals	for 8-way distribution box, 3-pole Spring clamp plug-in terminals	for 10-way distribution box, 3-pole Spring clamp plug-in terminals
Contact layout	<p>M8-Females 3-pole</p>  <p>for 1 signal per port</p>			
2 Cable Type	Jacket Color – No./diameter of wires			
	gray	gray	gray	gray
PUR/PVC	337 – 4 × 0.34 + 2 × 0.75 mm ²	350 – 6 × 0.34 + 2 × 0.75 mm ²	357 – 8 × 0.34 + 2 × 0.75 mm ²	385 – 10 × 0.34 + 2 × 0.75 mm ²
PUR (UL/CSA), robots/C-tracks	334 – 4 × 0.34 + 2 × 0.75 mm ²	356 – 6 × 0.34 + 2 × 0.75 mm ²	359 – 8 × 0.34 + 2 × 0.75 mm ²	384 – 10 × 0.34 + 2 × 0.75 mm ²
3 Cable Length				
3.0 m	0300			
5.0 m	0500			
10.0 m	1000			
15.0 m	1500			
Technical Data				
Total current	max. 8 A			
Temperature range	-20...+80 °C, depending on cable quality			
Article No.				
The composition of your article number is explained on page 3.1.i	<div style="display: flex; justify-content: space-around; align-items: center;"> 8 0 0 0 - - </div>			
	1	2	3	
	Form	Cable Type	Cable Length	
Notes				

M8 DISTRIBUTION SYSTEMS

For sensors and actuators

– Connection cap with homerun cable



Exact8

Connection cap short



Exact8

Connection cap long



1 Form	84149	86149	88149
Type	for 4-way distribution box, 4-pole Spring clamp plug-in terminals	for 6-way distribution box, 4-pole Spring clamp plug-in terminals	for 8-way distribution box, 4-pole Spring clamp plug-in terminals
Contact layout	<p>M8-Females 4-pole</p> <p>4 (S1) 2 (S2) 3 (-) 1 (+)</p> <p>for 2 signals per port 1 2</p>	<p>M8-Females 4-pole</p> <p>4 (S1) 2 (S2) 3 (-) 1 (+)</p> <p>for 2 signals per port 1 2</p>	
2 Cable Type	Jacket Color – No./diameter of wires		
	gray	gray	gray
PUR/PVC	358 – 8 × 0.34 + 2 × 0.75 mm ²	386 – 12 × 0.34 + 2 × 0.75 mm ²	395 – 16 × 0.34 + 2 × 0.75 mm ²
PUR (UL/CSA), robots/Ctracks	360 – 8 × 0.34 + 2 × 0.75 mm ²	389 – 12 × 0.34 + 2 × 0.75 mm ²	396 – 16 × 0.34 + 2 × 0.75 mm ²
3 Cable Length			
3.0 m	0300		
5.0 m	0500		
10.0 m	1000		
15.0 m	1500		
Technical Data			
Total current	max. 8 A		
Temperature range	-20...+80 °C, depending on cable quality		
Article No.			
The composition of your article number is explained on page 3.1.i	<div style="display: flex; justify-content: space-around; align-items: center;"> 8 0 0 0 - - - - - </div>		
	1 Form	2 Cable Type	3 Cable Length
Notes			

M8 DISTRIBUTION SYSTEMS

For sensors and actuators

– Connection cap without homerun cable

– Field-wireable

Exact8

Connection cap short



Exact8

Connection cap long



1 Form

84949

for 4-way distribution box, 3/4-pole, for 4...10-way, 3-pole

Spring clamp plug-in terminals

3-pole M8-Females 4-pole

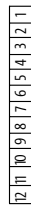
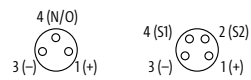

80949

6-, and 8-way distribution box, 4-pole

Spring clamp plug-in terminals

M8-Females 4-pole

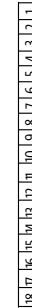
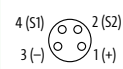

Technical Data

Total current	max. 8 A
Housing	Plastic, flame retardant
Temperature range	-20...+80 °C

Article No.

The composition of your article number is explained on page 3.1.i

8 0 0 0

- - - - -

0 0 0

0 0 0 0

1 Form

Notes

M8 DISTRIBUTION SYSTEMS

For sensors and actuators

– Sets (basic module and cap)

– Inline face or side mounting

Exact8

4-way



Exact8

6-way



Exact8

8-way



Exact8

10-way



Approvals: **UL**
Listed

1 Form	84040	86040	88040	80040										
Type	3-pole	3-pole	3-pole	3-pole										
Contact layout	<p>M8-Females 3-pole</p> <p>for 1 signal per port</p>													
2 Cable Type	<p>Jacket Color – No./diameter of wires</p> <table border="1"> <thead> <tr> <th></th> <th>gray</th> <th>gray</th> <th>gray</th> <th>gray</th> </tr> </thead> <tbody> <tr> <td>PUR (UL/CSA), robots/C-tracks</td> <td>334 – 4 × 0.34 + 2 × 0.75 mm²</td> <td>356 – 6 × 0.34 + 2 × 0.75 mm²</td> <td>359 – 8 × 0.34 + 2 × 0.75 mm²</td> <td>384 – 10 × 0.34 + 2 × 0.75 mm²</td> </tr> </tbody> </table>					gray	gray	gray	gray	PUR (UL/CSA), robots/C-tracks	334 – 4 × 0.34 + 2 × 0.75 mm ²	356 – 6 × 0.34 + 2 × 0.75 mm ²	359 – 8 × 0.34 + 2 × 0.75 mm ²	384 – 10 × 0.34 + 2 × 0.75 mm ²
	gray	gray	gray	gray										
PUR (UL/CSA), robots/C-tracks	334 – 4 × 0.34 + 2 × 0.75 mm ²	356 – 6 × 0.34 + 2 × 0.75 mm ²	359 – 8 × 0.34 + 2 × 0.75 mm ²	384 – 10 × 0.34 + 2 × 0.75 mm ²										
3 Cable Length	<table border="1"> <tbody> <tr> <td>3.0 m</td> <td>0300</td> </tr> <tr> <td>5.0 m</td> <td>0500</td> </tr> <tr> <td>10.0 m</td> <td>1000</td> </tr> <tr> <td>15.0 m</td> <td>1500</td> </tr> </tbody> </table>				3.0 m	0300	5.0 m	0500	10.0 m	1000	15.0 m	1500		
3.0 m	0300													
5.0 m	0500													
10.0 m	1000													
15.0 m	1500													
Technical Data	<table border="1"> <tbody> <tr> <td>Operating voltage</td> <td>24 V DC</td> </tr> <tr> <td>Total current</td> <td>max. 8 A</td> </tr> <tr> <td>Protection</td> <td>IP67 inserted and tightened (EN 60529)</td> </tr> <tr> <td>Temperature range</td> <td>-20...+80 °C, depending on cable quality</td> </tr> </tbody> </table>				Operating voltage	24 V DC	Total current	max. 8 A	Protection	IP67 inserted and tightened (EN 60529)	Temperature range	-20...+80 °C, depending on cable quality		
Operating voltage	24 V DC													
Total current	max. 8 A													
Protection	IP67 inserted and tightened (EN 60529)													
Temperature range	-20...+80 °C, depending on cable quality													
Contact Layout	<table border="1"> <tbody> <tr> <td>LED display</td> <td>LED (green): Power / LED (yellow): (S1)</td> </tr> <tr> <td>PIN 1</td> <td>(+)</td> </tr> <tr> <td>PIN 3</td> <td>(-)</td> </tr> <tr> <td>PIN 4</td> <td>(NO)/(S1)</td> </tr> </tbody> </table>				LED display	LED (green): Power / LED (yellow): (S1)	PIN 1	(+)	PIN 3	(-)	PIN 4	(NO)/(S1)		
LED display	LED (green): Power / LED (yellow): (S1)													
PIN 1	(+)													
PIN 3	(-)													
PIN 4	(NO)/(S1)													
Article No.	<p>The composition of your article number is explained on page 3.1.i</p> <p>8 0 0 0 – – – – –</p>													
	1 Form	2 Cable Type	3 Cable Length											
Notes														

M8 DISTRIBUTION SYSTEMS

For sensors

- M12 plug connection
- 8-pole
- Inline face or side mounting

Approvals:  Listed

Exact8
4-way



Exact8
6-way



1 Form

84070

86070

Type
Contact layout

3-pole

3-pole

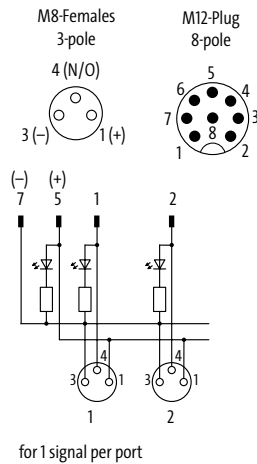

Technical Data

Operating voltage	24 V DC
Operating current per contact	max. 2 A
Protection	IP65/IP67
Housing	Plastic, flame retardant
Temperature range	-20...+70 °C, depending on cable quality

Contact Layout

LED display	LED (green): Power / LED (yellow): (S1)
PIN 1	(+)
PIN 3	(-)
PIN 4	(NO)/(S1)

Article No.

The composition of your article number is explained on page 3.1.i

8 0 0 0

-

-

0 0 0

0 0 0 0

1 Form

Notes

M8 DISTRIBUTION SYSTEMS

For sensors

- M12 plug connection
- 12-pole
- Inline face or side mounting

Approvals:  Listed

Exact8
4-way



Exact8
6-way



Exact8
8-way



Exact8
10-way

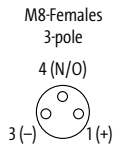
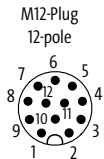
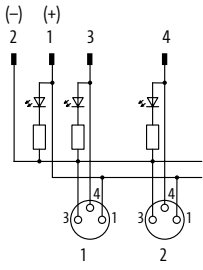

1 Form	84060	86060	88060	80060
Type	3-pole	3-pole	3-pole	3-pole
Contact layout	   <p>for 1 signal per port</p>			
Technical Data				
Operating voltage	24 V DC			
Operating current per contact	max. 1.5 A			
Protection	IP67 inserted and tightened (EN 60529)			
Housing	Plastic, flame retardant			
Temperature range	-20...+70 °C, depending on cable quality			
Contact Layout				
LED display	LED (green): Power / LED (yellow): (S1)			
PIN 1	(+)			
PIN 3	(-)			
PIN 4	(NO)/(S1)			
Article No.				
The composition of your article number is explained on page 3.1.i	<u>8</u> <u>0</u> <u>0</u> <u>0</u>	-	<u>0</u> <u>0</u> <u>0</u>	<u>0</u> <u>0</u> <u>0</u> <u>0</u>
	1 Form			
Notes				

M8 DISTRIBUTION SYSTEMS

For sensors

- M12 plug connection
- 12-pole
- Inline face or side mounting

Approvals:  Listed

Exact8
4-way



1 Form 84160

Type 4-pole

Contact layout

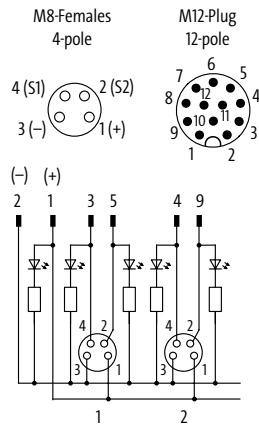

for 2 signals per port

Technical Data

Operating voltage	24 V DC
Operating current per contact	max. 1.5 A
Protection	IP67 inserted and tightened (EN 60529)
Housing	Plastic, flame retardant
Temperature range	-20...+70 °C, depending on cable quality

Contact Layout

LED display	LED (green): Power / LED (yellow): (S1) / LED (white): Signal (S2)
PIN 1	(+)
PIN 2	(NC)/(S2)
PIN 3	(-)
PIN 4	(NO)/(S1)

Article No.

The composition of your article number is explained on page 3.1.i	<u>8</u> <u>0</u> <u>0</u> <u>0</u> - <u>8</u> <u>4</u> <u>1</u> <u>6</u> <u>0</u> - <u>0</u> <u>0</u> <u>0</u> <u>0</u>
---	--

1 Form

Notes

M8 DISTRIBUTION SYSTEMS

Plug accessories			Art-No.
	Torque wrench set M8 (0.4 Nm, SW9)	M8 data connectors	7000-99101-0000000
	Screw plug M8 x 1 mm (for female) Plastic, hex without gasket	Quantity: 10 pcs.	3858627
	Adapter M8/M12 3-pole	M8 Distribution Systems	7000-88521-0000000
	4-pole	M8 Distribution Systems	7000-88531-0000000
	Label plates KES 20 x 8 (white)	(10 pieces/2 plates)	996067
	T-coupler (Nano) Distribution function (NO)	M8 distribution systems, 4-pole	7000-88602-0000000
	Screw plug M12 x 1 mm (for male) Plastic	Quantity: 4 pcs.	56951
Homerun cable accessories			Art-No.
	Connection cap short Spring clamp terminals, 12-pole	4-way distribution box, 3/4-pole, 4...10-way, 3-pole Cable diameter (7.4...13 mm)	8000-84949-0000000
	Connection cap long Spring clamp terminals, 18-pole	6-, and 8-way distribution box, 4-pole Cable diameter (7.4...13 mm)	8000-80949-0000000
	Cable rings (50 m), 3-pole, PUR/PVC 4x0.34 + 2x0.75 mm ²	4-way distribution boxes M8	8000-00000-3375000
	4x0.34 + 2x0.75 mm ²	4-way distribution boxes M8	8000-00000-3345000

M8 DISTRIBUTION SYSTEMS

Homerun cable accessories			Art-No.
	Cable rings (50 m), 3-pole, PUR/PVC 6×0.34 + 2×0.75 mm ²	6-way distribution boxes M8	8000-00000-3505000
	6×0.34 + 2×0.75 mm ²	6-way distribution boxes M8	8000-00000-3565000
	Cable rings (50 m), 3-pole, PUR/PVC 8×0.34 + 2×0.75 mm ²	8-way distribution boxes M8	8000-00000-3575000
	8×0.34 + 2×0.75 mm ²	8-way distribution boxes M8	8000-00000-3595000
	Cable rings (50 m), 3-pole, PUR/PVC 10×0.34 + 2×0.75 mm ²	10-way distribution boxes M8	8000-00000-3855000
	10×0.34 + 2×0.75 mm ²	10-way distribution boxes M8	8000-00000-3845000
	Cable rings (50 m), 4-pole, PUR/PVC 8×0.34 + 2×0.75 mm ²	4-way distribution boxes M8	8000-00000-3585000
	8×0.34 + 2×0.75 mm ²	4-way distribution boxes M8	8000-00000-3605000
	Cable rings (50 m), 4-pole, PUR/PVC 12×0.34 + 2×0.75 mm ²	6-way distribution boxes M8	8000-00000-3865000
	12×0.34 + 2×0.75 mm ²	6-way distribution boxes M8	8000-00000-3895000
	Cable rings (50 m), 4-pole, PUR/PVC 16×0.34 + 2×0.75 mm ²	8-way distribution boxes M8	8000-00000-3955000
	16×0.34 + 2×0.75 mm ²	8-way distribution boxes M8	8000-00000-3965000
	Cable rings (50 m), 4-pole, PUR (UL/CSA), halogen free 20×0.34 + 2×0.75 mm ²	10-way distribution boxes M8	8000-00000-4115000
	20×0.34 + 2×0.75 mm ²	10-way distribution boxes M8	8000-00000-4125000

M8 Distribution Systems Technical Data

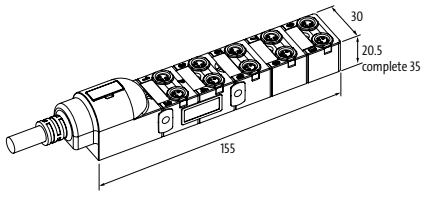
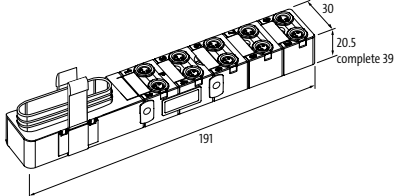
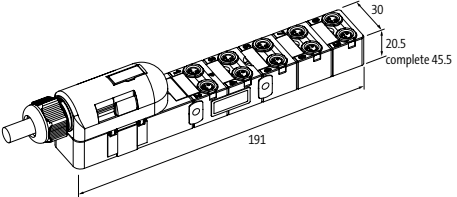
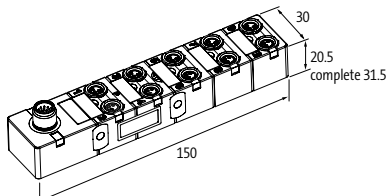
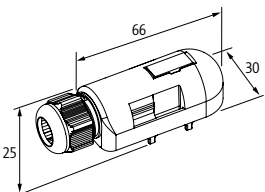
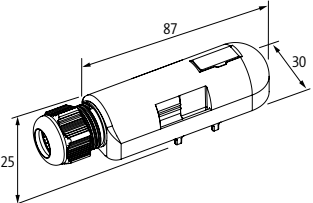
	Description Exact8 Molded homerun cable	4-way 96 mm	6-way 109 mm	8-way 132 mm	10-way 155 mm
	Description Exact8 Basic module 3-pole Basic module 4-pole	4-way 132 mm 132 mm	6-way 145 mm 166 mm	8-way 168 mm 189 mm	10-way 191 mm –
	Description Exact8 Sets 3-pole Sets 4-pole	4-way 132 mm 132 mm	6-way 145 mm 166 mm	8-way 168 mm 189 mm	10-way 191 mm –
	Description Exact8 M12 plug connection	4-way 91.5 mm	6-way 104 mm	8-way 127 mm	10-way 150 mm
	Description Exact8 Short connection cap				
	Description Exact8 Long connection cap				



M12 DISTRIBUTION SYSTEMS METAL

- Rugged
- Resistant to media
- Sealed

POTTED FORMS FOR HARSH ENVIRONMENTS

- Metal housing withstands mechanical and thermal stress, with molded cable or maintenance-friendly M23 plug connection
- High quality PUR cable: suitable for C-tracks, halogen-free, wider wire cross sections for higher current capacity
- Shielded models for sensitive digital or analog signals for an EMC compatible installation
- Universal configuration - contacts designed 1:1
- Fully potted

With molded homerun cable or M23 plug connection



MVP12 Metal

- 4-, 8-way
- With LED for PNP or NPN signals
- Without LED for analog signals and voltages up to 125 VAC/DC
- With PUR homerun cable or M23 connection

Page 4.12.1



MVP12 Metal UNIVERSAL

- 4-way
- M12 Pin 1, 2, 3, and 4 freely configurable

Page 4.12.8

M12 DISTRIBUTION SYSTEMS (METAL)

For sensors and actuators

– with molded homerun cable

– unshielded



MVP12 Metal

4-way
for PNP signals 24 V DC



MVP12 Metal

8-way
for PNP signals 24 V DC



1 Form	54510	58510								
Type	PNP, 5-pole	PNP, 5-pole								
Contact layout										
2 Cable Type	Jacket Color – No./diameter of wires									
	gray	gray								
PUR (UL/CSA), robots/Ctracks	448 – 8 × 0.5 + 3 × 1.0 mm ²	452 – 16 × 0.5 + 3 × 1.0 mm ²								
3 Cable Length										
3.0 m	0300									
5.0 m	0500									
10.0 m	1000									
15.0 m	1500									
Technical Data										
Operating voltage	24 V DC									
Total current	max. 7.5 A									
Protection	IP65, IP67, IP68									
Temperature range	-20...+90 °C, depending on cable quality									
Contact Layout										
LED display	LED (green): Power / LED (yellow): (S1/S2)									
PIN 1	(+) (Pin 1)									
PIN 2	(NC)/(S2) (Pin 2)									
PIN 3	(-) (Pin 3)									
PIN 4	(NO)/(S1) (Pin 4)									
PIN 5	(Earth) (Pin 5)									
Article No.										
The composition of your article number is explained on page 3.1.i	<table border="1"> <tr> <td>8</td> <td>0</td> <td>0</td> <td>0</td> <td>-</td> <td>-</td> <td>-</td> <td>-</td> </tr> </table>		8	0	0	0	-	-	-	-
8	0	0	0	-	-	-	-			
	1 Form	2 Cable Type	3 Cable Length							
Notes										

M12 Distribution Systems (Metal)

M12 DISTRIBUTION SYSTEMS (METAL)

For sensors and actuators

– with molded homerun cable

– unshielded



MVP12 Metal

8-way
with potential separation



MVP12 Metal

4-way
without LED



1 Form		58 610	54 512
Type		PNP, 5-pole	without LED, 5-pole (for analog signals)
Contact layout		<p>for 2 signals per port</p>	<p>for 2 signals per port</p>
2 Cable Type		Jacket Color – No./diameter of wires	
PUR (UL/CSA), robots/C-tracks		gray 403 – 16 × 0.34 + 5 × 0.75 mm ²	gray 448 – 8 × 0.5 + 3 × 1.0 mm ²
3 Cable Length			
3.0 m		0300	
5.0 m		0500	
10.0 m		1000	
15.0 m		1500	
Technical Data			
Operating voltage		24 V DC	max. 125 V AC/DC
Total current		max. 7.5 A	
Protection		IP65, IP67, IP68	
Temperature range		-20...+90 °C, depending on cable quality	
Contact Layout			
LED display		LED (green): Power / LED (yellow): (S1/S2)	–
PIN 1		(+)	
PIN 2		(NC)/(S2)	
PIN 3		(-)	
PIN 4		(NO)/(S1)	
PIN 5		(Earth)	
Article No.			
The composition of your article number is explained on page 3.1.i		<div style="display: flex; justify-content: space-around; align-items: center;"> 8 0 0 0 - - - - </div>	
		1 Form	2 Cable Type
		3 Cable Length	
Notes			

M12 Distribution Systems (Metal)

M12 DISTRIBUTION SYSTEMS (METAL)

For sensors and actuators

– with molded homerun cable

– unshielded



MVP12 Metal

8-way
without LED



MVP12 Metal

8-way
for NPN signals 24 V DC



1 Form		58512	58511
Type		without LED, 5-pole (for analog signals)	NPN, 5-pole
Contact layout		<p>for 2 signals per port</p>	<p>for 2 signals per port</p>
2 Cable Type	Jacket Color – No./diameter of wires	gray	gray
		452 – 16 × 0.5 + 3 × 1.0 mm ²	452 – 16 × 0.5 + 3 × 1.0 mm ²
3 Cable Length			
		3.0 m	0300
		5.0 m	0500
		10.0 m	1000
		15.0 m	1500
Technical Data			
Operating voltage		max. 125 V AC/DC	24 V DC
Total current		max. 7.5 A	
Protection		IP65, IP67, IP68	
Temperature range		-20...+90 °C, depending on cable quality	
Contact Layout			LED (green): Power / LED (yellow): (S1/S2)
LED display		–	
PIN 1		(+)	
PIN 2		(NC)/(S2)	
PIN 3		(-)	
PIN 4		(NO)/(S1)	
PIN 5		(Earth)	
Article No.			
The composition of your article number is explained on page 3.1.i		8 0 0 0	
		1 Form	2 Cable Type
			3 Cable Length
Notes			

M12 Distribution Systems (Metal)

M12 DISTRIBUTION SYSTEMS (METAL)

For sensors and actuators

– with molded homerun cable

– shielded



MVP12 Metal

4-way



MVP12 Metal

8-way



1 Form

54 515

58 515

Type without LED, 5-pole (for analog signals)

Type without LED, 5-pole (for analog signals)

Contact layout

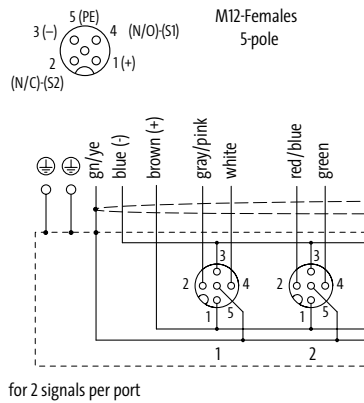

2 Cable Type

Jacket Color – No./diameter of wires

PUR (UL/CSA), robots/C-tracks

gray
373 – 8 × 0.34 + 3 × 0.75 mm²

gray
401 – 16 × 0.34 + 3 × 0.75 mm²

3 Cable Length

3.0 m	0300
5.0 m	0500
10.0 m	1000
15.0 m	1500

Technical Data

Operating voltage	max. 125 V AC/DC
Total current	max. 7.5 A
Protection	IP65, IP67, IP68
Temperature range	-20...+90 °C, depending on cable quality

Contact Layout

PIN 1	(+)
PIN 2	(NC)/(S2)
PIN 3	(-)
PIN 4	(NO)/(S1)
PIN 5	(Earth)
Shield	via M12 thread

Article No.

The composition of your article number is explained on page 3.1.i

8 0 0 0 - - - - -

1 Form

2 Cable Type

3 Cable Length

Notes

M12 Distribution Systems (Metal)

M12 DISTRIBUTION SYSTEMS (METAL)

For sensors and actuators

– with molded homerun cable

– shielded

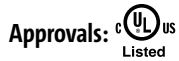

MVP12 Metal

4-way
for PNP signals 24 V DC



MVP12 Metal

8-way
for PNP signals 24 V DC



1 Form	54513	58513								
Type	PNP, 5-pole	PNP, 5-pole								
Contact layout										
2 Cable Type	Jacket Color – No./diameter of wires									
	gray	gray								
PUR (UL/CSA), robots/C-tracks	373 – 8 × 0.34 + 3 × 0.75 mm ²	401 – 16 × 0.34 + 3 × 0.75 mm ²								
3 Cable Length										
3.0 m	0300									
5.0 m	0500									
10.0 m	1000									
15.0 m	1500									
Technical Data										
Operating voltage	24 V DC									
Total current	max. 7.5 A									
Protection	IP65, IP67, IP68									
Temperature range	-20...+90 °C, depending on cable quality									
Contact Layout										
LED display	LED (green): Power / LED (yellow): (S1/S2)									
PIN 1	(+) (N/C)/(S2)									
PIN 2	(-)									
PIN 3	(N/O)/(S1)									
PIN 4	(Earth)									
Shield	via M12 thread									
Article No.										
The composition of your article number is explained on page 3.1.i	<table border="1"> <tr> <td>8</td> <td>0</td> <td>0</td> <td>0</td> <td>-</td> <td>-</td> <td>-</td> <td>-</td> </tr> </table>		8	0	0	0	-	-	-	-
8	0	0	0	-	-	-	-			
	1 Form	2 Cable Type	3 Cable Length							
Notes										

M12 Distribution Systems (Metal)

M12 DISTRIBUTION SYSTEMS (METAL)

For sensors and actuators

- M23 plug connection, 19-pole
- for unshielded or shielded use

Approvals:  Listed

MVP12 Metal

4-way
for PNP signals 24 V DC



MVP12 Metal

8-way
for PNP signals 24 V DC



1 Form

54520

58520

Type

PNP, 5-pole

PNP, 5-pole

Contact layout

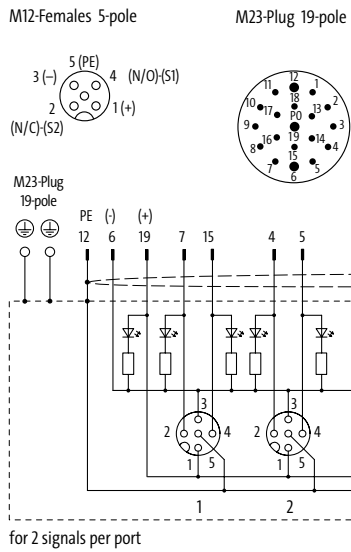

Technical Data

Operating voltage	24 V DC
Operating current per contact	max. 4 A
Total current	max. 7.5 A
Protection	IP65, IP67, IP68
Housing	Zinc die casting, matte nickel plated
Temperature range	-25...+90 °C

Contact Layout

LED display	LED (green): Power / LED (yellow): (S1/S2)
PIN 1	(+)
PIN 2	(NC)/(S2)
PIN 3	(-)
PIN 4	(NO)/(S1)
PIN 5	(Earth)
Shield	via M12 outer thread and M23 outer thread

Article No.

The composition of your article number is explained on page 3.1.i

8 0 0 0

-

0 0 0

0 0 0 0

1 Form

Notes

M12 DISTRIBUTION SYSTEMS (METAL)

For sensors and actuators

- M23 plug connection, 19-pole
- for unshielded or shielded use

Approvals:  **UL**
Listed

MVP12 Metal

4-way



MVP12 Metal

8-way

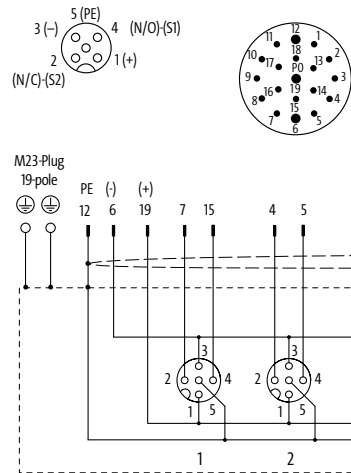

1 Form	54522	58522
---------------	--------------	--------------

Type	without LED, 5-pole (for analog signals)	without LED, 5-pole (for analog signals)
Contact layout	<p>M12-Females 5-pole M23-Plug 19-pole</p>  <p>for 2 signals per port</p>	

Technical Data		
-----------------------	--	--

Operating voltage	max. 125 V AC/DC	
Operating current per contact	max. 4 A	
Total current	max. 7.5 A	
Protection	IP65, IP67, IP68	
Housing	Zinc die casting, matte nickel plated	
Temperature range	-25...+80 °C	

Contact Layout		
-----------------------	--	--

PIN 1	(+)	
PIN 2	(NC)/(S2)	
PIN 3	(-)	
PIN 4	(NO)/(S1)	
PIN 5	(Earth)	
Shield	via M12 outer thread and M23 outer thread	

Article No.		
--------------------	--	--

The composition of your article number is explained on page 3.1.i	8 0 0 0	-	-	0 0 0	0 0 0 0
	1 Form				

Notes		
--------------	--	--

M12 Distribution Systems (Metal)

M12 DISTRIBUTION SYSTEMS (METAL)

For harsh environments

– for unshielded or shielded use

MVP12 Metal UNIVERSAL

with molded homerun cable

4-way



1 Form **54712**

Type **without LED, 5-pole (for analog signals)**

Contact layout

M12-Females 5-pole

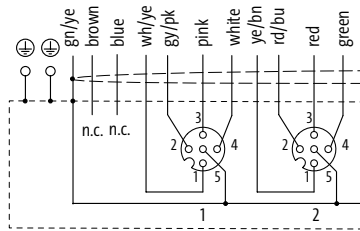
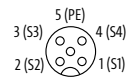

for 4 signals per port
free arrangeable, PE bridged

2 Cable Type **Jacket Color** – No./diameter of wires

Jacket Color **gray**
PUR (UL/CSA), robots/C-tracks **401 – 16 × 0.34 + 3 × 0.75 mm²**

3 Cable Length

3.0 m **0300**
5.0 m **0500**
10.0 m **1000**
15.0 m **1500**

Technical Data

Operating voltage max. 42 V AC/DC
Total current max. 10 A
Protection IP65, IP67, IP68
Temperature range -20...+90 °C, depending on cable quality

Contact Layout

PIN 1 (S1)
PIN 2 (S2)
PIN 3 (S3)
PIN 4 (S4)
PIN 5 (Earth)
Shield via M12 thread

Article No.

The composition of your article number is explained on page 3.1.i

8 0 0 0

–

5 4 7 1 2

–

– – –

– – – –

1 Form

2 Cable Type

3 Cable Length

Notes

M12 DISTRIBUTION SYSTEMS (METAL)

For harsh environments

– for unshielded or shielded use

MVP12 Metal UNIVERSAL

M23 plug connection, 19-pole
4-way



Approvals: UL
Listed

1 Form 54722

Type without LED, 5-pole (for analog signals)

Contact layout

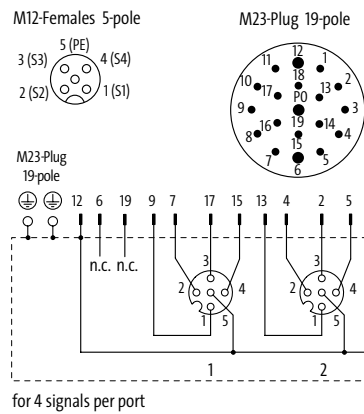

Technical Data

Operating voltage	max. 125 V AC/DC
Operating current per contact	max. 4 A
Total current	max. 7.5 A
Protection	IP65, IP67, IP68
Housing	Zinc die casting, matte nickel plated
Locking of ports	Screw thread M12 × 1 mm
Temperature range	-25...+90 °C

Contact Layout

PIN 1	(S1)
PIN 2	(S2)
PIN 3	(S3)
PIN 4	(S4)
PIN 5	(S5)/(Earth)

Article No.













The composition of your article number is explained on page 3.1.i

8 0 0 0 - 5 4 7 2 2 - 0 0 0 0 0 0 0

1 Form

Notes

M12 DISTRIBUTION SYSTEMS (METAL)

Mounting accessories			Art-No.
	Torque wrench set M12 (0.6 Nm, SW13)	M12 data connector molded (standard)	7000-99102-000000
	Torque wrench M12 (0.6 Nm, SW13)	M12 data connector molded (standard)	7000-99109-000000
	Torque wrench M12 (0.6 Nm, SW14)	M12 data connector moulded (Xtreme)	7000-99108-000000
	Torque wrench M12 (0.6 Nm, SW17)	M12 field-wireable (IDC terminal)	7000-99094-000000
	Torque wrench M12 (0.6 Nm, SW18)	M12 field-wireable via (screw terminals)	7000-99103-000000
	DIN-rail adapter with fixing screws, plastic		27905
	Earth connection set		996064
	V2A-base plate	MVP12 Metal, 4-way	996065
		MVP12 Metal, 8-way	996066
	Ground strap 4 mm² 100 mm for hole (M3)		4000-71001-041003
	End fitting set M3	Ground straps	4000-71003-0101403
Plug accessories			Art-No.
	Torque wrench set M12 (0.6 Nm, SW13)	M12 data connector molded (standard)	7000-99102-000000
	Screw plug M12 × 1 mm Metal, hex, 1 piece		996049

M12 DISTRIBUTION SYSTEMS (METAL)

Plug accessories			Art-No.
	Label plates KES 20 × 8 (white)	(10 pieces/2 plates)	996067
	Adapter M8/M12 3-pole 4-pole	M12 Distribution Systems M12 Distribution Systems	7000-42201-000000 7000-42211-000000
Homerun cable accessories			Art-No.
	Screw plug M23 Metal		55352
	Cable rings (50 m), 5-pole, PUR (UL/CSA), halogen free 8×0.5 + 3×1.0 mm ² 16×0.5 + 3×1.0 mm ² 16×0.34 + 5×0.75 mm ²	4-way distribution boxes M12 8-way distribution boxes M12 8-way distribution boxes M12, potentially separated	8000-00000-4485000 8000-00000-4525000 8000-00000-4035000
	Cable rings (50 m), 5-pole, PUR (UL/CSA), halogen free 8×0.34 + 3×0.75 mm ² 16×0.34 + 3×0.75 mm ²	4-way distribution boxes M12, shielded 8-way distribution boxes M12, shielded	8000-00000-3735000 8000-00000-4015000

M12 DISTRIBUTION SYSTEMS (METAL)

M12 Distribution Systems Technical Data

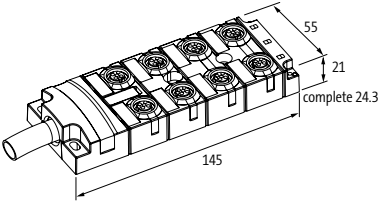
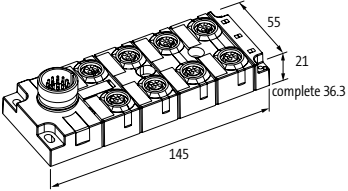
	Description	4-way	8-way
	MVP Metal and MVP Metal UNIVERSAL Molded homerun cable	95 mm	145 mm
	Description	4-way	8-way
	MVP Metal and MVP Metal UNIVERSAL M23 plug connection	95 mm	145 mm

M12 DISTRIBUTION SYSTEMS PLASTIC

- Fully potted, sealed
- Highly resistant
- Application oriented

PLUGGABLE CONNECTIONS FROM THE PROCESS TO THE CONTROL

- Quick installation with pre-wired and tested cables
- Easy to separate during transportation and simple when redesigning your system, rapid replacement of damaged cables
- Double assignment of M12 ports saves space
- Safety models for inputs and outputs according to EN ISO 13849-2
- Universal configuration – contacts designed 1:1

Pluggable or pre-wired homerun cable

 <p>Exact12</p> <ul style="list-style-type: none"> • 4-, 8-way • With LED for PNP or NPN signals • Without LED for voltages up to 125 V AC/DC • Analog signals • ATEX <p><i>Page 4.13.1</i></p>	 <p>Exact12</p> <ul style="list-style-type: none"> • 4-, 8-way • With pluggable 8- or 12-pole M12 connection • With pluggable 12- or 19-pole M23 connection <p><i>Page 4.13.27</i></p>
 <p>Exact12 basic modules</p> <ul style="list-style-type: none"> • 4-, 8-way • With LED for PNP or NPN signals • Without LED for voltages up to 125 V AC/DC • Analog signals <p><i>Page 4.13.8</i></p>	 <p>Exact12/MVP12 connection caps</p> <ul style="list-style-type: none"> • Field-wireable with screw or spring clamp terminals • With pre-wired homerun cable and screw plug terminals <p><i>Page 4.13.14</i></p>
 <p>Exact12 set</p> <ul style="list-style-type: none"> • 4-, 8-way • With pluggable cap and screw plug terminals or spring clamp terminals <p><i>Page 4.13.17</i></p>	 <p>Exact12 with connection on the back</p> <ul style="list-style-type: none"> • 8-way • With pluggable connection on the back • Potential separation optional <p><i>Page 4.13.25</i></p>
 <p>Exact12 UNIVERSAL</p> <ul style="list-style-type: none"> • 4-way • M12 pin 1, 2, 3, and 4 freely configurable <p><i>Page 4.13.30</i></p>	 <p>Exact12 – safety distribution system</p> <ul style="list-style-type: none"> • 8-way • Potential separation optional <p><i>Page 4.13.31</i></p>

M12 DISTRIBUTION SYSTEMS (PLASTIC)

For sensors and actuators

– with molded homerun cable

Exact12

4-way
for PNP signals 24 V DC



Exact12

8-way
for PNP signals 24 V DC



Approvals: UL_{us}
Listed

1 Form		84410	88410
Type	PNP, 4-pole		PNP, 4-pole
Contact layout	M12-Females 4-pole for 1 signal per port		M12-Females 4-pole for 1 signal per port
2 Cable Type	Jacket Color – No./diameter of wires		
	gray	gray	
PUR/PVC	333 – 4 × 0.34 + 3 × 0.75 mm ²		
PUR/PVC (UL/CSA), C-tracks		362 – 8 × 0.34 + 3 × 0.75 mm ²	
PUR (UL/CSA), robots/C-tracks		447 – 8 × 0.5 + 3 × 1.0 mm ²	
3 Cable Length			
3.0 m	0300		
5.0 m	0500		
10.0 m	1000		
15.0 m	1500		
Technical Data			
Operating voltage	24 V DC		
Total current	max. 8 A		
Protection	IP65/IP67		
Temperature range	-20...+70 °C, depending on cable quality		
Contact Layout			
LED display	LED (green): Power / LED (yellow): (S1)		
PIN 1	(+)		
PIN 3	(-)		
PIN 4	(NO)/(S1)		
PIN 5	(Earth)		
Article No.			
The composition of your article number is explained on page 3.1.i	<div style="display: flex; justify-content: space-around; align-items: center;"> 8 0 0 0 - - </div>		
	1 Form	2 Cable Type	3 Cable Length
Notes	Further cable lengths on request.		

M12 DISTRIBUTION SYSTEMS (PLASTIC)

For sensors and actuators

– with molded homerun cable

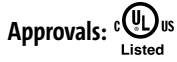

Exact12

4-way
for NPN signals 24 V DC



Exact12

8-way
for NPN signals 24 V DC



1 Form

8 4 4 1 1

NPN, 4-pole

Type
Contact layout

M12-Females 4-pole

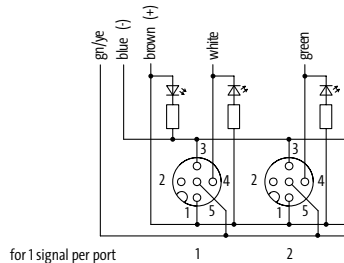
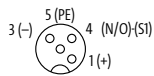

for 1 signal per port

8 8 4 1 1

NPN, 4-pole

M12-Females 4-pole

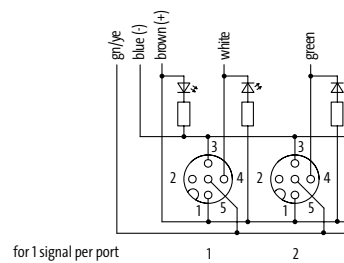
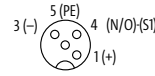

for 1 signal per port

2 Cable Type

Jacket Color – No./diameter of wires

PUR/PVC
PUR/PVC (UL/CSA), C-tracks
PUR (UL/CSA), robots/C-tracks

gray
333 – 4 × 0.34 + 3 × 0.75 mm²

gray
362 – 8 × 0.34 + 3 × 0.75 mm²
447 – 8 × 0.5 + 3 × 1.0 mm²

3 Cable Length

5.0 m **0500**
10.0 m **1000**

Technical Data

Operating voltage	24 V DC	
Total current	max. 8 A	max. 10 A
Protection	IP65/IP67	
Temperature range	-20...+70 °C, depending on cable quality	

Contact Layout

LED display	LED (green): Power / LED (yellow): (S1)
PIN 1	(+)
PIN 3	(-)
PIN 4	(NO)/(S1)
PIN 5	(Earth)

Article No.

The composition of your article number is explained on page 3.1.i

8 0 0 0 - - - - -

1 Form

2 Cable Type

3 Cable Length

Notes

Further cable lengths on request.

M12 DISTRIBUTION SYSTEMS (PLASTIC)

For sensors and actuators

– with molded homerun cable

Exact12

4-way
without LED



Exact12

8-way
without LED

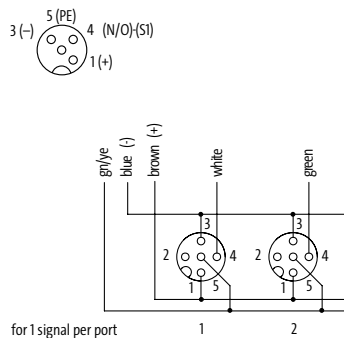
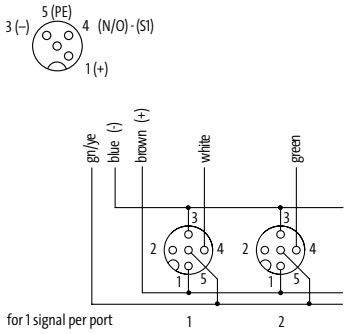

Approvals:  UL us
Listed

1 Form	84412	88412
Type	without LED, 4-pole	without LED, 4-pole
Contact layout	<p>M12-Females 4-pole</p>  <p>for 1 signal per port</p>	<p>M12-Females 4-pole</p>  <p>for 1 signal per port</p>
2 Cable Type	Jacket Color – No./diameter of wires	
	gray	gray
	PUR/PVC 333 – 4 × 0.34 + 3 × 0.75 mm ²	PUR/PVC (UL/CSA), Ctracks 362 – 8 × 0.34 + 3 × 0.75 mm ²
	PUR (UL/CSA), robots/Ctracks	PUR (UL/CSA), robots/Ctracks 447 – 8 × 0.5 + 3 × 1.0 mm ²
3 Cable Length		
	5.0 m	0500
	10.0 m	1000
Technical Data		
	Operating voltage 125 V AC/DC	
	Total current max. 8 A	
	Protection IP65/IP67	
	Temperature range -20...+70 °C, depending on cable quality	
Contact Layout		
	PIN 1 (+)	
	PIN 3 (-)	
	PIN 4 (NO)/(S1)	
	PIN 5 (Earth)	
Article No.		
	The composition of your article number is explained on page 3.1.i	
	8 0 0 0	- - - - -
	1	2
	Form	Cable Type
	3	3
	Cable Length	Cable Length
Notes		
	Further cable lengths on request.	

M12 DISTRIBUTION SYSTEMS (PLASTIC)

For sensors and actuators

– with molded homerun cable



Exact12

4-way
for PNP signals 24 V DC



Exact12

8-way
for PNP signals 24 V DC



1 Form

84510

PNP, 5-pole

M12-Females 5-pole

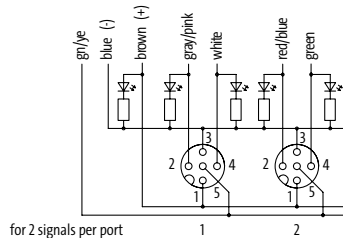
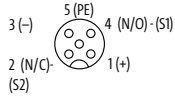

for 2 signals per port

88510

PNP, 5-pole

M12-Females 5-pole

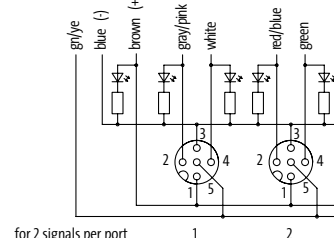
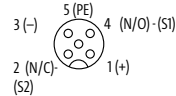

for 2 signals per port

2 Cable Type

Jacket Color – No./diameter of wires

gray

363 – 8 × 0.34 + 3 × 0.75 mm²

448 – 8 × 0.5 + 3 × 1.0 mm²

gray

452 – 16 × 0.5 + 3 × 1.0 mm²

398 – 16 × 0.34 + 3 × 0.75 mm²

3 Cable Length

3.0 m	0300
5.0 m	0500
10.0 m	1000
15.0 m	1500

Technical Data

Operating voltage	24 V DC
Total current	max. 8 A
Protection	IP65/IP67
Temperature range	-20...+70 °C, depending on cable quality

Contact Layout

LED display	LED (green): Power / LED (yellow): (S1) / LED (white): Signal (S2)
PIN 1	(+)
PIN 2	(NC)/(S2)
PIN 3	(-)
PIN 4	(NO)/(S1)
PIN 5	(Earth)

Article No.

The composition of your article number is explained on page 3.1.i

8 0 0 0 - - - - -

1 Form

2 Cable Type

3 Cable Length

Notes

Further cable lengths on request.

M12 DISTRIBUTION SYSTEMS (PLASTIC)

For sensors and actuators

– with molded homerun cable

Exact12

4-way
for PNP signals 24 V DC
ATEX Zone 2 and 22



Exact12

8-way
for PNP signals 24 V DC
ATEX Zone 2 and 22

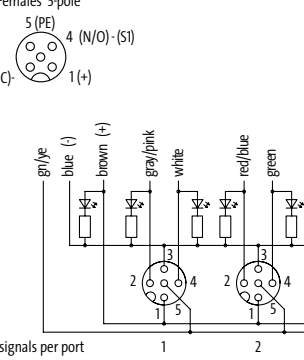
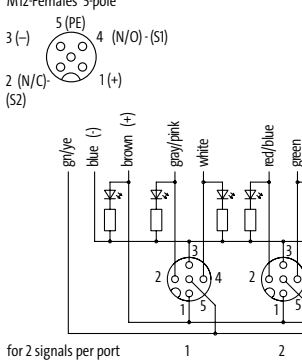

Approvals:  

1 Form		84510	88510
Type	PNP, 5-pole		PNP, 5-pole
Contact layout	M12-Females 5-pole 3 (-) 4 (N/O)-(S1) 2 (N/C)-(S2) 1 (+)  for 2 signals per port		M12-Females 5-pole 3 (-) 4 (N/O)-(S1) 2 (N/C)-(S2) 1 (+)  for 2 signals per port
2 Cable Type	Jacket Color – No./diameter of wires		
	gray		gray
PUR (UL/CSA), robots/Ctracks	448 – 8 × 0.5 + 3 × 1.0 mm ²		452 – 16 × 0.5 + 3 × 1.0 mm ²
3 Cable Length			
3.0 m	0300		
5.0 m	0500		
10.0 m	1000		
15.0 m	1500		
Technical Data			
Operating voltage	24 V DC		
Total current	max. 8 A		
Protection	IP65/IP67		
Temperature range	-20...+70 °C, depending on cable quality		
Contact Layout			
LED display	LED (green): Power / LED (yellow): (S1) / LED (white): Signal (S2)		
PIN 1	(+) (S2)		
PIN 2	(NC)/(S2)		
PIN 3	(-)		
PIN 4	(NO)/(S1)		
PIN 5	(Earth)		
Article No.			
The composition of your article number is explained on page 3.1.i	<div style="display: flex; justify-content: space-around; align-items: center;"> 8 0 9 9 - - </div>		
	1 Form	2 Cable Type	3 Cable Length
Notes	Further cable lengths on request.		

M12 DISTRIBUTION SYSTEMS (PLASTIC)

For sensors and actuators

– with molded homerun cable



Exact12

4-way
for NPN signals 24 V DC



Exact12

8-way
for NPN signals 24 V DC



1 Form

84511

NPN, 5-pole

Type
Contact layout

M12-Females 5-pole

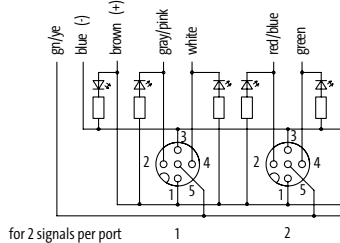
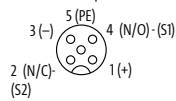

for 2 signals per port

88511

NPN, 5-pole

M12-Females 5-pole

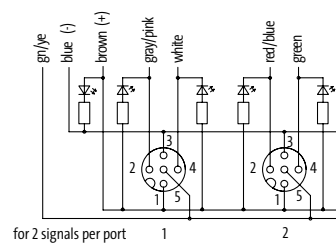
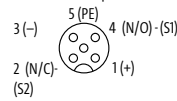

for 2 signals per port

2 Cable Type

Jacket Color – No./diameter of wires

PUR/PVC
PUR (UL/CSA), robots/C-tracks
PUR/PVC (UL/CSA), C-tracks

gray
363 – 8 × 0.34 + 3 × 0.75 mm²
448 – 8 × 0.5 + 3 × 1.0 mm²

gray
452 – 16 × 0.5 + 3 × 1.0 mm²
398 – 16 × 0.34 + 3 × 0.75 mm²

3 Cable Length

5.0 m **0500**
10.0 m **1000**

Technical Data

Operating voltage 24 V DC
Total current max. 8 A
Protection IP65/IP67
Temperature range -20...+70 °C, depending on cable quality

Contact Layout

LED display LED (green): Power / LED (yellow): (S1) / LED (white): Signal (S2)
PIN 1 (+)
PIN 2 (NC)/(S2)
PIN 3 (-)
PIN 4 (NO)/(S1)
PIN 5 (Earth)

Article No.

The composition of your article number is explained on page 3.1.i

8 0 0 0 - - - - -

1 Form

2 Cable Type

3 Cable Length

Notes

Further cable lengths on request.

M12 DISTRIBUTION SYSTEMS (PLASTIC)

For sensors and actuators

– with molded homerun cable

Exact12

4-way
without LED



Exact12

8-way
without LED

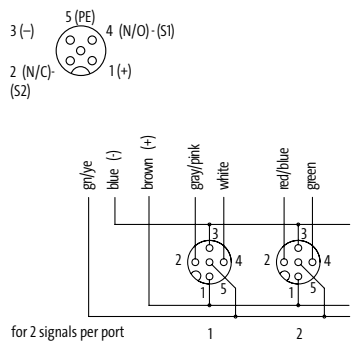
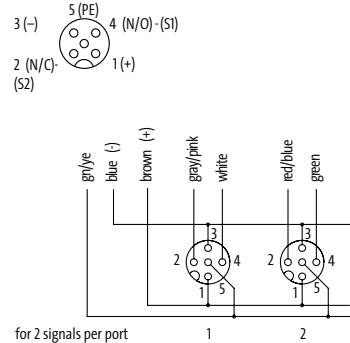

Approvals: 

1 Form		84512	88512												
Type		without LED, 5-pole	without LED, 5-pole												
Contact layout		<p>M12-Females 5-pole</p>  <p>for 2 signals per port</p>	<p>M12-Females 5-pole</p>  <p>for 2 signals per port</p>												
2 Cable Type		<p>Jacket Color – No./diameter of wires</p> <table border="1"> <thead> <tr> <th></th> <th>gray</th> <th>gray</th> </tr> </thead> <tbody> <tr> <td>PUR/PVC</td> <td>363 – 8 × 0.34 + 3 × 0.75 mm²</td> <td></td> </tr> <tr> <td>PUR (UL/CSA), robots/C-tracks</td> <td>448 – 8 × 0.5 + 3 × 1.0 mm²</td> <td>452 – 16 × 0.5 + 3 × 1.0 mm²</td> </tr> <tr> <td>PUR/PVC (UL/CSA), C-tracks</td> <td></td> <td>398 – 16 × 0.34 + 3 × 0.75 mm²</td> </tr> </tbody> </table>			gray	gray	PUR/PVC	363 – 8 × 0.34 + 3 × 0.75 mm ²		PUR (UL/CSA), robots/C-tracks	448 – 8 × 0.5 + 3 × 1.0 mm ²	452 – 16 × 0.5 + 3 × 1.0 mm ²	PUR/PVC (UL/CSA), C-tracks		398 – 16 × 0.34 + 3 × 0.75 mm ²
	gray	gray													
PUR/PVC	363 – 8 × 0.34 + 3 × 0.75 mm ²														
PUR (UL/CSA), robots/C-tracks	448 – 8 × 0.5 + 3 × 1.0 mm ²	452 – 16 × 0.5 + 3 × 1.0 mm ²													
PUR/PVC (UL/CSA), C-tracks		398 – 16 × 0.34 + 3 × 0.75 mm ²													
3 Cable Length		<table border="1"> <tbody> <tr> <td>5.0 m</td> <td>0500</td> </tr> <tr> <td>10.0 m</td> <td>1000</td> </tr> </tbody> </table>		5.0 m	0500	10.0 m	1000								
5.0 m	0500														
10.0 m	1000														
Technical Data		<table border="1"> <tbody> <tr> <td>Operating voltage</td> <td>125 V AC/DC</td> </tr> <tr> <td>Total current</td> <td>max. 8 A</td> </tr> <tr> <td>Protection</td> <td>IP65/IP67</td> </tr> <tr> <td>Temperature range</td> <td>-20...+70 °C, depending on cable quality</td> </tr> </tbody> </table>		Operating voltage	125 V AC/DC	Total current	max. 8 A	Protection	IP65/IP67	Temperature range	-20...+70 °C, depending on cable quality				
Operating voltage	125 V AC/DC														
Total current	max. 8 A														
Protection	IP65/IP67														
Temperature range	-20...+70 °C, depending on cable quality														
Contact Layout		<table border="1"> <tbody> <tr> <td>PIN 1</td> <td>(+)</td> </tr> <tr> <td>PIN 2</td> <td>(NC)/(S2)</td> </tr> <tr> <td>PIN 3</td> <td>(-)</td> </tr> <tr> <td>PIN 4</td> <td>(NO)/(S1)</td> </tr> <tr> <td>PIN 5</td> <td>(Earth)</td> </tr> </tbody> </table>		PIN 1	(+)	PIN 2	(NC)/(S2)	PIN 3	(-)	PIN 4	(NO)/(S1)	PIN 5	(Earth)		
PIN 1	(+)														
PIN 2	(NC)/(S2)														
PIN 3	(-)														
PIN 4	(NO)/(S1)														
PIN 5	(Earth)														
Article No.		<table border="1"> <tbody> <tr> <td style="text-align: center;">8 0 0 0</td> <td style="text-align: center;">-</td> <td style="text-align: center;">-</td> <td style="text-align: center;">-</td> </tr> </tbody> </table>		8 0 0 0	-	-	-								
8 0 0 0	-	-	-												
The composition of your article number is explained on page 3.1.i		1 Form	2 Cable Type												
			3 Cable Length												
Notes		Further cable lengths on request.													

M12 DISTRIBUTION SYSTEMS (PLASTIC)

For sensors and actuators

- Base modules

Approvals: 

Exact12

4-way
for PNP signals 24 V DC



Exact12

8-way
for PNP signals 24 V DC



1 Form

84400

PNP, 4-pole

Type
Contact layout

M12-Females 4-pole

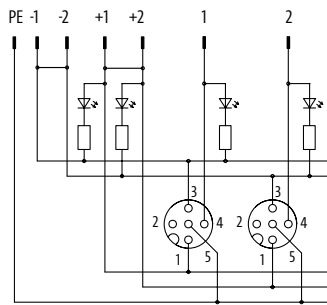
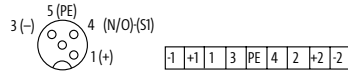

for 1 signal per port

88400

PNP, 4-pole

M12-Females 4-pole

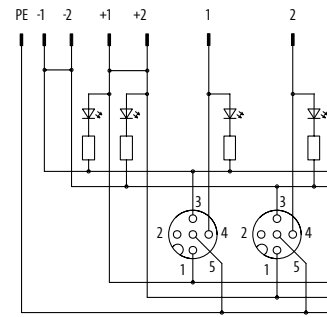
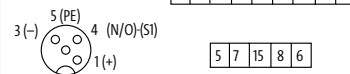

for 1 signal per port

Technical Data

Operating voltage	24 V DC
Operating current per contact	max. 4 A
Total current	max. 8 A
Protection	IP65/IP67
Housing	Plastic, flame retardant
Temperature range	-20...+70 °C

Contact Layout

LED display	LED (green): Power / LED (yellow): (S1)
PIN 1	(+)
PIN 3	(-)
PIN 4	(NO)/(S1)
PIN 5	(Earth)

Article No.

The composition of your article number is explained on page 3.1.i

8 0 0 0

-

0 0 0

0 0 0 0

1 Form

Notes

M12 DISTRIBUTION SYSTEMS (PLASTIC)

For sensors and actuators

– Base modules

Exact12

4-way
for NPN signals 24 V DC



Exact12

8-way
for NPN signals 24 V DC



Approvals: UL_{US}
Listed

1 Form		84401	88401
Type	NPN, 4-pole		NPN, 4-pole
Contact layout	M12-Females 4-pole for 1 signal per port 1 2		M12-Females 4-pole [-1 +1 1 3 PE 4 2 +2 -2] for 1 signal per port 1 2
Technical Data			
Operating voltage	24 V DC		
Operating current per contact	max. 4 A		
Total current	max. 8 A		
Protection	IP65/IP67		
Housing	Plastic, flame retardant		
Temperature range	-20...+70 °C		
Contact Layout			
LED display	LED (green): Power / LED (yellow): (S1)		
PIN 1	(+) 1		
PIN 3	(-) 3		
PIN 4	(NO)/(S1) 4		
PIN 5	(Earth) 5		
Article No.			
The composition of your article number is explained on page 3.1.i	<u>8</u> <u>0</u> <u>0</u> <u>0</u>	- - -	<u>0</u> <u>0</u> <u>0</u> <u>0</u> <u>0</u> <u>0</u> <u>0</u>
	1 Form		
Notes			

M12 DISTRIBUTION SYSTEMS (PLASTIC)

For sensors and actuators

– Base modules

Approvals:  Listed

Exact12

4-way
without LED



Exact12

8-way
without LED



1 Form

Type
Contact layout

84402

without LED, 4-pole

M12 Females 4-pole

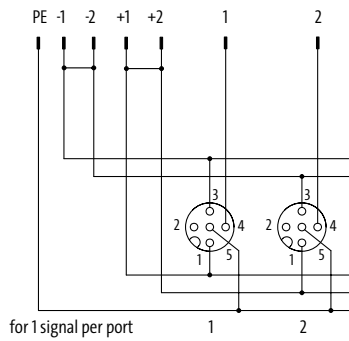
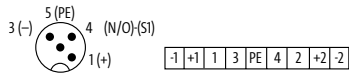

88402

without LED, 4-pole

M12-Females 4-pole

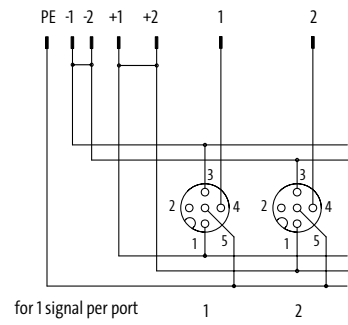
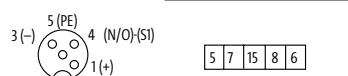

Technical Data

Operating voltage	125 V AC/DC
Operating current per contact	max. 4 A
Total current	max. 8 A
Protection	IP65/IP67
Housing	Plastic, flame retardant
Temperature range	-20...+70 °C

Contact Layout

PIN 1	(+)
PIN 3	(-)
PIN 4	(NO)/(S1)
PIN 5	(Earth)

Article No.

The composition of your article number is explained on page 3.1.i

8 0 0 0 - - - - - - - - - - 0 0 0 0 0 0 0

1 Form

Notes

M12 DISTRIBUTION SYSTEMS (PLASTIC)

For sensors and actuators

– Base modules

Exact12

4-way
for PNP signals 24 V DC



Exact12

8-way
for PNP signals 24 V DC



Approvals: UL[®] US
Listed

1 Form	84500	88500	
Type	PNP, 5-pole	PNP, 5-pole	
Contact layout	<p>M12-Females 5-pole</p> <p>for 2 signals per port</p>	<p>M12-Females 5-pole</p> <p>for 2 signals per port</p>	
Technical Data			
Operating voltage	24 V DC		
Operating current per contact	max. 4 A		
Total current	max. 8 A		
Protection	IP65/IP67		
Housing	Plastic, flame retardant		
Temperature range	-20...+70 °C		
Contact Layout			
LED display	LED (green): Power / LED (yellow): (S1) / LED (white): Signal (S2)		
PIN 1	(+) / (S1)		
PIN 2	(NC)/(S2)		
PIN 3	(-) / (S1)		
PIN 4	(NO)/(S1)		
PIN 5	(Earth)		
Article No.			
The composition of your article number is explained on page 3.1.i	8 0 0 0	0 0 0	0 0 0 0
	1 Form		
Notes			

M12 DISTRIBUTION SYSTEMS (PLASTIC)

For sensors and actuators

– Base modules



Exact12

4-way
for NPN signals 24 V DC



Exact12

8-way
for NPN signals 24 V DC



1 Form

Type
Contact layout

84501

NPN, 5-pole

M12-Females 5-pole

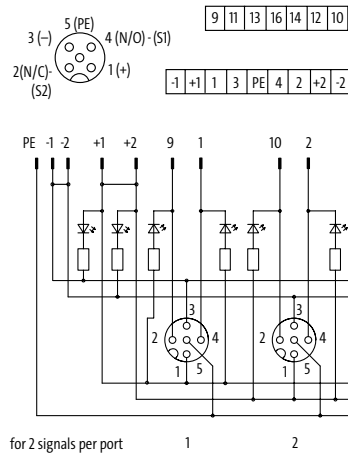

for 2 signals per port

88501

NPN, 5-pole

M12-Females 5-pole

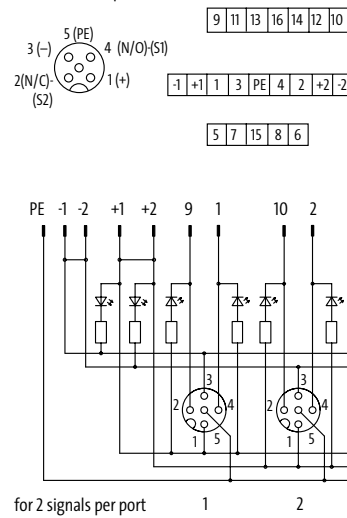

for 2 signals per port

Technical Data

Operating voltage	24 V DC
Operating current per contact	max. 4 A
Total current	max. 8 A
Protection	IP65/IP67
Housing	Plastic, flame retardant
Temperature range	-20...+70 °C

Contact Layout

LED display	LED (green): Power / LED (yellow): (S1) / LED (white): Signal (S2)
PIN 1	(+)
PIN 2	(NC)/(S2)
PIN 3	(-)
PIN 4	(NO)/(S1)
PIN 5	(Earth)

Article No.

The composition of your article number is explained on page 3.1.i

8 0 0 0

- - - - -

0 0 0

0 0 0 0

1 Form

Notes

M12 DISTRIBUTION SYSTEMS (PLASTIC)

For sensors and actuators

– Base modules

Exact12

4-way
without LED



Exact12

8-way
without LED



Approvals: UL Listed

1 Form	84502	88502	
Type	without LED, 5-pole	without LED, 5-pole	
Contact layout	<p>M12-Females 5-pole</p> <p>for 2 signals per port</p>	<p>M12-Females 5-pole</p> <p>for 2 signals per port</p>	
Technical Data			
Operating voltage	125 V AC/DC		
Operating current per contact	max. 4 A		
Total current	max. 8 A		
Protection	IP65/IP67		
Housing	Plastic, flame retardant		
Temperature range	-20...+70 °C		
Contact Layout			
PIN 1	(+) / (S1)		
PIN 2	(NC)/(S2)		
PIN 3	(-)		
PIN 4	(NO)/(S1)		
PIN 5	(Earth)		
Article No.			
The composition of your article number is explained on page 3.1.i	8 0 0 0	0 0 0	0 0 0 0
	1 Form		
Notes			

M12 DISTRIBUTION SYSTEMS (PLASTIC)

For sensors and actuators

– Connection cap with homerun cable

Exact12

for 4-way distribution boxes



1 Form	84459	84559	84659
Type	4-pole Screw plug-in terminals	5-pole Screw plug-in terminals	5-pole Screw plug-in terminals with potential separation
Contact layout	M12-Females 4-pole for 1 signal per port	M12-Females 5-pole Exact12 for 2 signals per port	
2 Cable Type	Jacket Color – No./diameter of wires		
PUR/PVC	gray 333 – 4 × 0.34 + 3 × 0.75 mm ²	gray 363 – 8 × 0.34 + 3 × 0.75 mm ²	gray 374 – 8 × 0.34 + 5 × 0.75 mm ²
PUR (UL/CSA), robots/Ctracks		448 – 8 × 0.5 + 3 × 1.0 mm ²	
3 Cable Length			
3.0 m	0300		
5.0 m	0500		
10.0 m	1000		
15.0 m	1500		
20.0 m	2000		
25.0 m	2500		
30.0 m	3000		
Technical Data			
Total current	max. 8 A		
Temperature range	-20...+80 °C, depending on cable quality		
Article No.			
The composition of your article number is explained on page 3.1.i	<div style="display: flex; justify-content: space-between; align-items: center;"> <u>8</u> <u>0</u> <u>0</u> <u>0</u> – – – </div>		
	1 Form	2 Cable Type	3 Cable Length
Notes			

M12 Distribution Systems (Plastic)

M12 DISTRIBUTION SYSTEMS (PLASTIC)

For sensors and actuators

– Connection cap with homerun cable

Exact12
for 8-way distribution boxes



1 Form	88459	88559	88659
Type	4-pole Screw plug-in terminals	5-pole Screw plug-in terminals	5-pole Screw plug-in terminals with potential separation
Contact layout	<p>M12 Females 4-pole</p> <p>for 1 signal per port</p>	<p>M12-Females 5-pole</p> <p>for 2 signals per port</p>	
2 Cable Type	Jacket Color – No./diameter of wires		
	gray	gray	gray
PUR/PVC			404 – 16 × 0.34 + 5 × 0.75 mm ²
PUR/PVC (UL/CSA), C-tracks	362 – 8 × 0.34 + 3 × 0.75 mm ²	398 – 16 × 0.34 + 3 × 0.75 mm ²	
PUR (UL/CSA), C-tracks	447 – 8 × 0.5 + 3 × 1.0 mm ²	452 – 16 × 0.5 + 3 × 1.0 mm ²	
3 Cable Length			
3.0 m	0300		
5.0 m	0500		
10.0 m	1000		
15.0 m	1500		
20.0 m	2000		
25.0 m	2500		
30.0 m	3000		
Technical Data			
Total current	max. 8 A		
Temperature range	-20...+80 °C, depending on cable quality		
Article No.			
The composition of your article number is explained on page 3.1.i	<div style="display: flex; justify-content: space-between; align-items: center;"> 8 0 0 0 - - - - </div>		
	1 Form	2 Cable Type	3 Cable Length
Notes			

M12 DISTRIBUTION SYSTEMS (PLASTIC)

For sensors and actuators

– Sets (basic module and cap)

– Field-wireable

Approvals:  **UL** us
Listed

Exact12

4-way

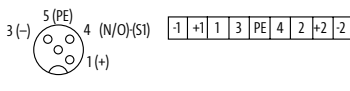
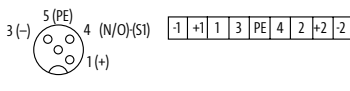
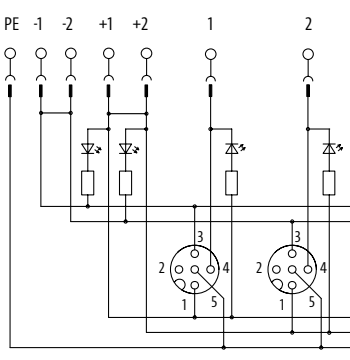

1 Form	84440	84450	84451	
Type	PNP, 4-pole	PNP, 4-pole	NPN, 4-pole	
	Spring clamp plug-in terminals	Screw plug-in terminals	Screw plug-in terminals	
Contact layout	M12-Females 4-pole 		M12-Females 4-pole 	
	 <p>for 1 signal per port</p>		 <p>for 1 signal per port</p>	
Technical Data				
Operating voltage	24 V DC			
Operating current per contact	max. 4 A			
Total current	max. 8 A			
Connection	Spring clamp plug-in terminals: max. 1.5 mm ² (AWG 16)	Screw plug-in terminals: max. 1.5 mm ² (AWG 16)		
Protection	IP65/IP67			
Housing	Plastic, flame retardant			
Temperature range	-20...+70 °C			
Contact Layout				
LED display	LED (green): Power / LED (yellow): (S1)			
PIN 1	(+)			
PIN 3	(-)			
PIN 4	(NO)/(S1)			
PIN 5	(Earth)			
Article No.				
The composition of your article number is explained on page 3.1.i	8 0 0 0	- - - - -	0 0 0	0 0 0 0
	1 Form			
Notes				

M12 DISTRIBUTION SYSTEMS (PLASTIC)

For sensors and actuators

– Sets (basic module and cap)

– Field-wireable

Exact12

4-way



1 Form

8 4 4 5 2

Type **without LED, 4-pole**
Screw plug-in terminals

Contact layout M12-Females 4-pole

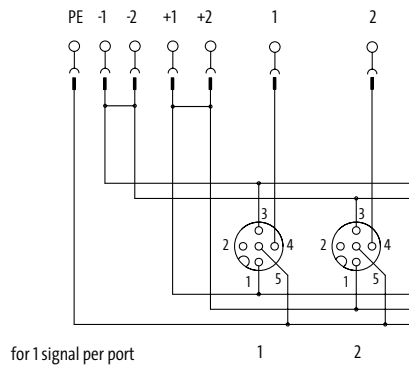

Technical Data

Operating voltage	125 V AC/DC
Operating current per contact	max. 4 A
Total current	max. 8 A
Connection	Screw plug-in terminals: max. 1.5 mm ² (AWG 16)
Protection	IP65/IP67
Housing	Plastic, flame retardant
Temperature range	-20...+70 °C

Contact Layout

PIN 1	(+)
PIN 3	(-)
PIN 4	(NO)/(S1)
PIN 5	(Earth)

Article No.

The composition of your article number is explained on page 3.1.i

8 0 0 0 - 8 4 4 5 2 - 0 0 0 0 0 0 0

1 Form

Notes

M12 DISTRIBUTION SYSTEMS (PLASTIC)

For sensors and actuators

– Sets (basic module and cap)

– Field-wireable

Approvals:  Listed

Exact12

4-way

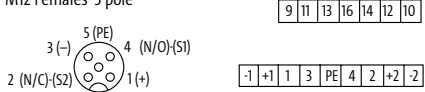
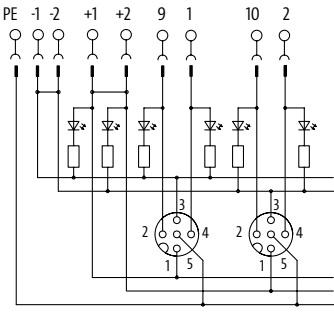

1 Form	84540	84550
	PNP, 5-pole Spring clamp plug-in terminals	PNP, 5-pole Screw plug-in terminals
Contact layout	<p>M12-Females 5-pole</p>  <p>for 2 signals per port</p> 	
Technical Data		
Operating voltage	24 V DC	
Operating current per contact	max. 4 A	
Total current	max. 8 A	
Connection	Spring clamp plug-in terminals: max. 1.5 mm ² (AWG 16)	Screw plug-in terminals: max. 1.5 mm ² (AWG 16)
Protection	IP65/IP67	
Housing	Plastic, flame retardant	
Temperature range	-20...+70 °C	
Contact Layout		
LED display	LED (green): Power / LED (yellow): (S1) / LED (white): Signal (S2)	
PIN 1	(+) / (S1)	
PIN 2	(NC)/(S2)	
PIN 3	(-)	
PIN 4	(NO)/(S1)	
PIN 5	(Earth)	
Article No.		
The composition of your article number is explained on page 3.1.i	8 0 0 0	0 0 0
	1 Form	
Notes		

M12 DISTRIBUTION SYSTEMS (PLASTIC)

For sensors and actuators

– Sets (basic module and cap)

– Field-wireable

Exact12

4-way



1 Form	84551	84552
Approvals	cULus	
Type	NPN, 5-pole	without LED, 5-pole
Contact layout	<p>M12-Females 5-pole</p> <p>9 11 13 16 14 12 10</p> <p>-1 +1 1 3 PE 4 2 +2 -2</p> <p>for 2 signals per port</p> <p>1 2</p>	<p>M12-Females 5-pole</p> <p>9 11 13 16 14 12 10</p> <p>-1 +1 1 3 PE 4 2 +2 -2</p> <p>for 2 signals per port</p> <p>1 2</p>
Technical Data		
Operating voltage	24 V DC	125 V AC/DC
Operating current per contact	max. 4 A	
Total current	max. 8 A	
Connection	Screw plug-in terminals: max. 1.5 mm ² (AWG 16)	
Protection	IP65/IP67	
Housing	Plastic, flame retardant	
Temperature range	-20...+70 °C	
Contact Layout		
LED display	LED (green): Power / LED (yellow): (S1) / LED (white): Signal (S2)	–
PIN 1	(+)	
PIN 2	(NC)/(S2)	
PIN 3	(-)	
PIN 4	(NO)/(S1)	
PIN 5	(Earth)	
Article No.		
The composition of your article number is explained on page 3.1.i	8 0 0 0 - - 0 0 0 0	0 0 0 0
	1 Form	
Notes		

M12 Distribution Systems (Plastic)

M12 DISTRIBUTION SYSTEMS (PLASTIC)

For sensors and actuators

– Sets (basic module and cap)

– Field-wireable

Approvals:  Listed

Exact12

8-way

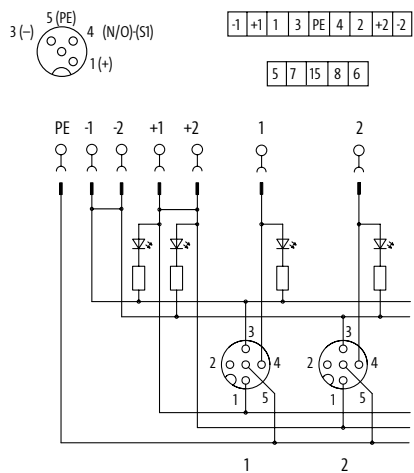

1 Form	88440	88450
Type	PNP, 4-pole Spring clamp plug-in terminals	PNP, 4-pole Screw plug-in terminals
Contact layout	<p>M12-Females 4-pole</p>  <p>for 1 signal per port</p>	
Technical Data		
Operating voltage	24 V DC	
Operating current per contact	max. 4 A	
Total current	max. 8 A	
Connection	Spring clamp plug-in terminals: max. 1.5 mm ² (AWG 16)	Screw plug-in terminals: max. 1.5 mm ² (AWG 16)
Protection	IP65/IP67	
Housing	Plastic, flame retardant	
Temperature range	-20...+70 °C	
Contact Layout		
LED display	LED (green): Power / LED (yellow): (S1)	
PIN 1	(+)	
PIN 3	(-)	
PIN 4	(NO)/(S1)	
PIN 5	(Earth)	
Article No.		
The composition of your article number is explained on page 3.1.i	<p style="text-align: center;">8 0 0 0 - 0 0 0 0 0 0 0</p>	
1 Form		
Notes		

M12 DISTRIBUTION SYSTEMS (PLASTIC)

For sensors and actuators

– Sets (basic module and cap)

– Field-wireable

Approvals:  Listed

Exact12

8-way

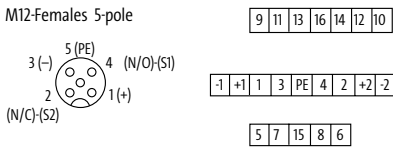
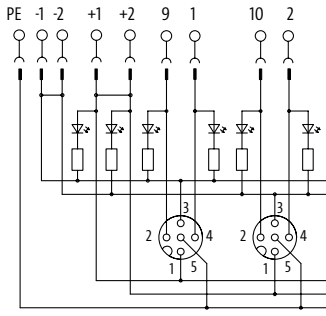

1 Form	88540	88550	
Type	PNP, 5-pole Spring clamp plug-in terminals	PNP, 5-pole Screw plug-in terminals	
Contact layout	<p>M12-Females 5-pole</p>   <p>for 2 signals per port</p>		
Technical Data			
Operating voltage	24 V DC		
Operating current per contact	max. 4 A		
Total current	max. 8 A		
Connection	Spring clamp plug-in terminals: max. 1.5 mm ² (AWG 16)	Screw plug-in terminals: max. 1.5 mm ² (AWG 16)	
Protection	IP65/IP67		
Housing	Plastic, flame retardant		
Temperature range	-20...+70 °C		
Contact Layout			
LED display	LED (green): Power / LED (yellow): (S1) / LED (white): Signal (S2)		
PIN 1	(+) / (S1)		
PIN 2	(NC)/(S2)		
PIN 3	(-)		
PIN 4	(NO)/(S1)		
PIN 5	(Earth)		
Article No.			
The composition of your article number is explained on page 3.1.i	8 0 0 0	0 0 0	0 0 0 0
	1 Form		
Notes			

M12 DISTRIBUTION SYSTEMS (PLASTIC)

For sensors and actuators

– Sets (basic module and cap)

– Field-wireable

Exact12

8-way



1 Form	88551	88552
	Approvals	cULus
Type	NPN, 5-pole	without LED, 5-pole
Contact layout	Screw plug-in terminals	Screw plug-in terminals
Technical Data	M12 Females 5-pole	M12 Females 5-pole
Operating voltage	24 V DC	125 V AC/DC
Operating current per contact	max. 4 A	
Total current	max. 8 A	
Connection	Screw plug-in terminals: max. 1.5 mm ² (AWG 16)	
Protection	IP65/IP67	
Housing	Plastic, flame retardant	
Temperature range	-20...+70 °C	
Contact Layout		
LED display	LED (green): Power / LED (yellow): (S1) / LED (white): Signal (S2)	–
PIN 1	(+)	
PIN 2	(NC)/(S2)	
PIN 3	(-)	
PIN 4	(NO)/(S1)	
PIN 5	(Earth)	
Article No.		
The composition of your article number is explained on page 3.1.i	8 0 0 0 – — — — – 0 0 0 0 0 0 0	
	1 Form	
Notes		

M12 Distribution Systems (Plastic)

M12 DISTRIBUTION SYSTEMS (PLASTIC)

For sensors and actuators

– Rear connection

Approvals:  **UL** us
Listed

Exact12



Exact12

with potential separation

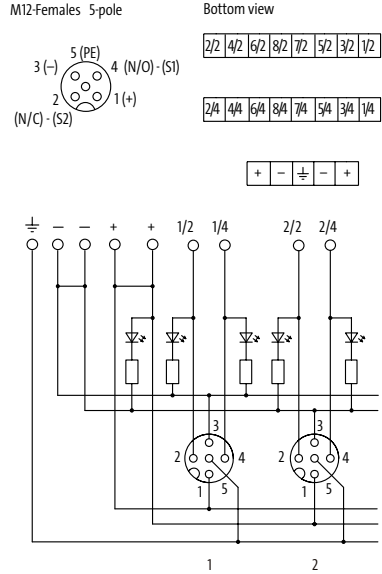
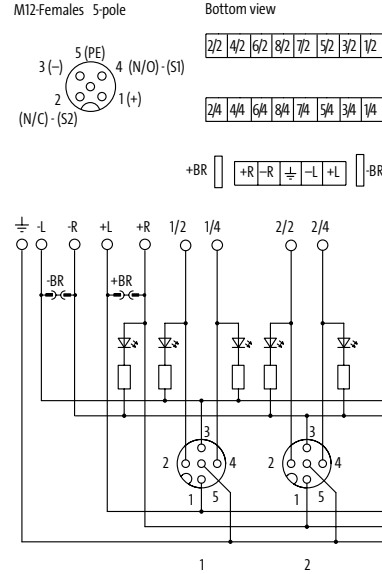

1 Form	88580	88680
Type	PNP, 5-pole Spring clamp terminals	PNP, 5-pole Spring clamp terminals
Contact layout	<p>M12-Females 5-pole Bottom view</p>  <p>for 2 signals per port</p>	<p>M12-Females 5-pole Bottom view</p>  <p>for 2 signals per port</p>
Technical Data		
Operating voltage	24 V DC	
Operating current per contact	max. 4 A	
Total current	max. 2 × 8 A	
Protection	IP65/IP67	
Housing	Plastic, flame retardant	
Temperature range	-20...+70 °C	
Contact Layout		
LED display	LED (green): Power / LED (yellow): (S1) / LED (white): Signal (S2)	
PIN 1	(+) / (NC)/(S2)	
PIN 2	(-)	
PIN 3	(NO)/(S1)	
PIN 4	(Earth)	
Article No.		
The composition of your article number is explained on page 3.1.i	<div style="display: flex; justify-content: space-around; align-items: center;"> 8 0 0 0 - - 0 0 0 0 </div>	
	1 Form	
Notes		

M12 DISTRIBUTION SYSTEMS (PLASTIC)

For sensors and actuators

Exact12

Pluggable rear connection



Exact12

Pluggable rear connection with potential separation



Approvals: UL US Listed

1 Form

88590

PNP, 5-pole

Spring clamp plug-in terminals

Contact layout

M12-Females 5-pole

Bottom view

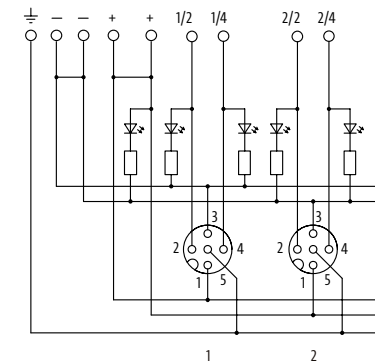
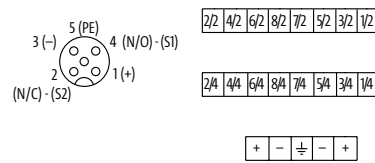

for 2 signals per port

88690

PNP, 5-pole

Spring clamp plug-in terminals

M12-Females 5-pole

Bottom view

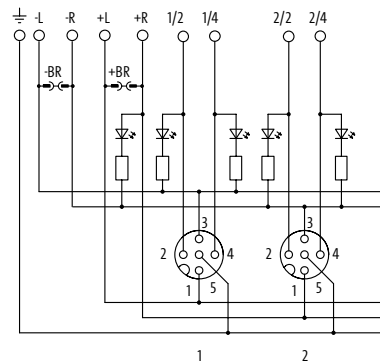
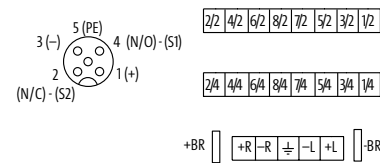

for 2 signals per port

Technical Data

Operating voltage	24 V DC
Operating current per contact	max. 4 A
Total current	max. 2 × 8 A
Protection	IP65/IP67
Housing	Plastic, flame retardant
Temperature range	-20...+70 °C

Contact Layout

LED display	LED (green): Power / LED (yellow): (S1) / LED (white): Signal (S2)
PIN 1	(+)
PIN 2	(NC)/(S2)
PIN 3	(-)
PIN 4	(NO)/(S1)
PIN 5	(Earth)

Article No.

The composition of your article number is explained on page 3.1.i

8 0 0 0

- - - - -

0 0 0

0 0 0 0

1 Form

Notes

M12 DISTRIBUTION SYSTEMS (PLASTIC)

For sensors and actuators

– M12 plug connection

Exact12

4-way



Exact12

8-way



Exact12

4-way



Approvals: **UL** ^{us}
Listed

1 Form	84470	88460	84560
Type	5-, 4-pole M12 plug connection, 8-pole	5-, 4-pole M12 plug connection, 12-pole	5-pole M12 plug connection, 12-pole
Contact layout	<p>M12-Females</p> <p>5-pole 4-pole</p> <p>2 signals 1 signal</p> <p>M12-Plug</p> <p>8-pole</p> <p>2 signals 1 signal</p> <p>M12-Plug 8-pole (-) (+) 7 5 1, 2, 6, 8 3+4</p> <p>1+2 3+4</p>	<p>M12-Females</p> <p>5-pole 4-pole</p> <p>2 signals 1 signal</p> <p>M12-Plug</p> <p>12-pole</p> <p>2 signals 1 signal</p> <p>M12-Plug 12-pole (-) (+) 2 1 3, 4, 11, 12 5...10</p> <p>1+2 3...8</p>	<p>M12-Females</p> <p>5-pole</p> <p>2 signals</p> <p>M12-Plug</p> <p>12-pole</p> <p>2 signals 1 signal</p> <p>M12-Plug 12-pole (-) (+) 2 1 5 3 9 4</p> <p>for 2 signals per port 1 2</p>
Technical Data	<p>Operating voltage 24 V DC</p> <p>Operating current per contact max. 2 A max. 1.5 A</p> <p>Total current max. 2 A max. 1.5 A</p> <p>Protection IP65/IP67</p> <p>Housing Plastic, flame retardant</p> <p>Temperature range -20...+70 °C</p>		
Contact Layout	<p>LED display LED (green): Power / LED (yellow): (S1) / LED (white): Signal (S2)</p> <p>PIN 1 (+)</p> <p>PIN 2 (NC)/(S2)</p> <p>PIN 3 (-)</p> <p>PIN 4 (NO)/(S1)</p> <p>PIN 5 (Earth)</p>		
Article No.	<p>The composition of your article number is explained on page 3.1.i</p> <p>8 0 0 0 - - - - - 0 0 0 0 0 0 0 0</p>		
Notes	<p>1 Form</p>		

M12 DISTRIBUTION SYSTEMS (PLASTIC)

For sensors and actuators

– M23 plug connection

Approvals:  Listed

Exact12

4-way



Exact12

8-way



1 Form

84530

88430

Type

5-pole

4-pole

Contact layout

M23 plug connection, 12-pole

M23 plug connection, 12-pole

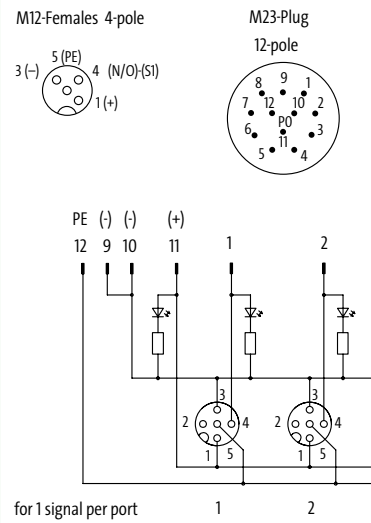
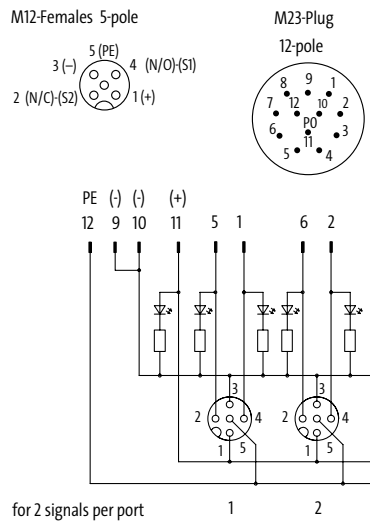

Technical Data

Operating voltage	24 V DC
Operating current per contact	max. 4 A
Total current	max. 8 A
Protection	IP65/IP67
Housing	Plastic, flame retardant
Temperature range	-20...+75 °C

Contact Layout

LED display	LED (green): Power / LED (yellow): (S1) / LED (white): Signal (S2)	LED (green): Power / LED (yellow): (S1)
PIN 1	(+)	
PIN 2	(NC)/(S2)	–
PIN 3	(-)	
PIN 4	(NO)/(S1)	
PIN 5	(Earth)	

Article No.

The composition of your article number is explained on page 3.1.i

8 0 0 0

–

–

0 0 0

–

0 0 0 0

1 Form

Notes

M12 DISTRIBUTION SYSTEMS (PLASTIC)

For sensors and actuators

– M23 plug connection

Approvals:  UL US
Listed

Exact12

4-way



Exact12

8-way

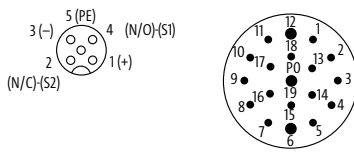
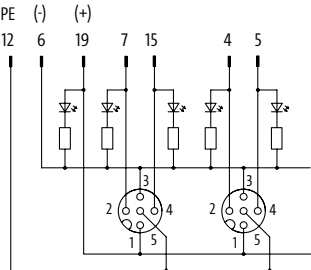

1 Form	84520	88520
Type	5-pole M23 plug connection, 19-pole	5-pole M23 plug connection, 19-pole
Contact layout	<p>M12-Females 5-pole M23-Plug 19-pole</p>  <p>PE (-) (+) 12 6 19 7 15 4 5</p>  <p>for 2 signals per port 1 2</p>	
Technical Data		
Operating voltage	24 V DC	
Operating current per contact	max. 4 A	
Total current	max. 8 A	
Protection	IP65/IP67	
Housing	Plastic, flame retardant	
Temperature range	-20...+80 °C	
Contact Layout		
LED display	LED (green): Power / LED (yellow): (S1) / LED (white): Signal (S2)	
PIN 1	(+) / (NC)/(S2)	
PIN 2	(-)	
PIN 3	(NO)/(S1)	
PIN 4	(Earth)	
Article No.		
The composition of your article number is explained on page 3.1.i	<p>8 0 0 0 - - - - - 0 0 0 0 0 0 0</p>	
	1 Form	
Notes		

M12 DISTRIBUTION SYSTEMS (PLASTIC)

For general applications

– with molded homerun cable

Approvals:  Listed

Exact12 UNIVERSAL

4-way



1 Form

8 4 7 1 2

Type **without LED, 5-pole (for analog signals)**

Contact layout

M12-Females 5-pole

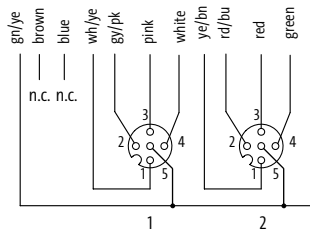
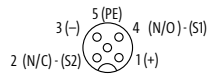

free arrangeable, contact 1:1 on terminals
for 4 signals per port, PINS bridged on terminals

2 Cable Type

Jacket Color – No./diameter of wires

gray

PUR/PVC (UL/CSA), Ctracks

398 – 16 × 0.34 + 3 × 0.75 mm²

3 Cable Length

3.0 m	0300
5.0 m	0500
10.0 m	1000
15.0 m	1500

Technical Data

Operating voltage	42 V AC/DC
Total current	max. 10 A
Protection	IP65/IP67
Temperature range	-20...+70 °C, depending on cable quality

Contact Layout

PIN 1	(S1)
PIN 2	(S2)
PIN 3	(S3)
PIN 4	(S4)
PIN 5	(Earth)

Article No.

The composition of your article number is explained on page 3.1.i

8 0 0 0

–

8 4 7 1 2

–

– – –

– – – –

1 Form

2 Cable Type

3 Cable Length

Notes

M12 DISTRIBUTION SYSTEMS (PLASTIC)

For safety wiring

- with molded homerun cable
- Homerun cable with spring clamp terminals
- EN ISO 13849-2

Approvals:  UL Listed

Exact12 Safety

8-way
for PNP signals 24 V DC

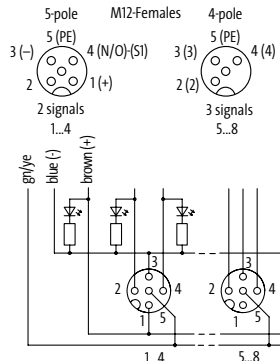

1 Form 98710

Type	PNP, 5-pole, 4/3-pole
Contact layout	 <p>5-pole M12-Females 4-pole 5 (PE) 4 (N/O)-(S1) 3 (3) 5 (PE) 4 (4) 3 (-) 1 (+) 2 (2) 3 signals 4 (4) 2 signals 1...4 5...8</p> <p>3-pole blue (-) brown (+) 1 2 3 4 5</p>

2 Cable Type Jacket Color – No./diameter of wires

	gray
PUR/PVC (UL/CSA)	407 – 20 × 0.34 + 3 × 0.75 mm ²

3 Cable Length

3.0 m	0300
5.0 m	0500
10.0 m	1000
15.0 m	1500

Technical Data

Operating voltage	24 V DC
Total current	max. 8 A
Protection	IP65/IP67
Temperature range	-20...+60 °C, depending on cable quality

Contact Layout

LED display	LED (green): Power / LED (yellow): (S1) / LED (white): Signal (S2) port 1...4
PIN 1	(+) port 1...4
PIN 2	(NC)/(S2) port 1...4; (S1) port 5...8
PIN 3	(-) port 1...4; (S2) port 5...8
PIN 4	(NO)/(S1) port 1...4; (S3) port 5...8
PIN 5	(Earth)

Article No.

The composition of your article number is explained on page 3.1.i	8 0 0 0 – 9 8 7 1 0 – _____
---	---

1 Form	2 Cable Type	3 Cable Length
---------------	---------------------	-----------------------

Notes

M12 DISTRIBUTION SYSTEMS (PLASTIC)

For safety wiring

– Basic module

– EN ISO 13849-2

Approvals:  Listed

Exact12 Safety

8-way
for PNP signals 24 V DC

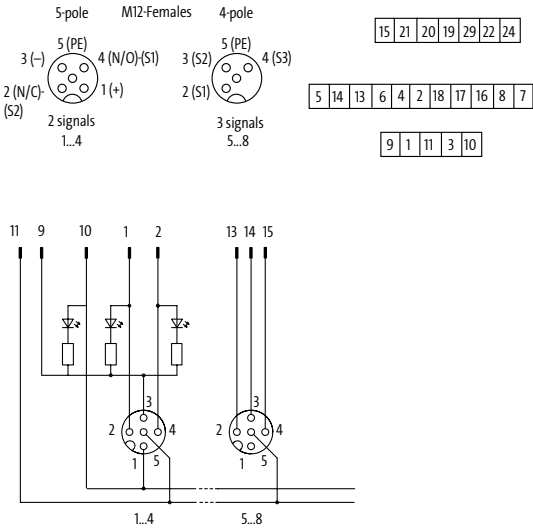

1 Form 98700

Type	PNP, 5-pole, 4/3-pole
Contact layout	 <p>5-pole M12-Females 4-pole</p> <p>3 (-) 5 (PE) 4 (N/O)-(S1) 3 (S2) 5 (PE) 4 (S3)</p> <p>2 (N/C)-(S2) 1 (+) 2 (S1)</p> <p>2 signals 1..4 3 signals 5..8</p> <p>15 21 20 19 29 22 24</p> <p>5 14 13 6 4 2 18 17 16 8 7</p> <p>9 1 11 3 10</p> <p>11 9 10 1 2 13 14 15</p> <p>1..4 5..8</p>

Technical Data

Operating voltage	24 V DC
Operating current per contact	max. 4 A
Total current	max. 8 A
Protection	IP65/IP67
Housing	Plastic, flame retardant
Locking of ports	Screw thread M12 × 1 mm
Temperature range	-20...+60 °C

Contact Layout

LED display	LED (green): Power / LED (yellow): (S1) / LED (white): Signal (S2) port 1...4
PIN 1	(+) port 1...4
PIN 2	(NC)/(S2) port 1...4; (S1) port 5...8
PIN 3	(-) port 1...4; (S2) port 5...8
PIN 4	(NO)/(S1) port 1...4; (S3) port 5...8
PIN 5	(Earth)

Article No.

The composition of your article number is explained on page 3.1.i	<u>8</u> <u>0</u> <u>0</u> <u>0</u> - <u>9</u> <u>8</u> <u>7</u> <u>0</u> <u>0</u> - <u>0</u> <u>0</u> <u>0</u> <u>0</u> <u>0</u>
	1 Form

Notes

Notes	
-------	--

M12 DISTRIBUTION SYSTEMS (PLASTIC)

For safety wiring

- Connection cap
- Homerun cable with spring clamp terminals
- EN ISO 13849-2

Approvals:  **UL** us
Listed

Exact12 Safety
for 8-way distribution boxes



1 Form 98749

Type

5-, 4-pole

Contact layout

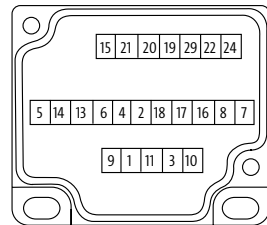
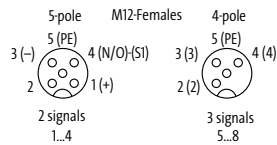

2 Cable Type Jacket Color – No./diameter of wires

PUR (UL/CSA), robots/C-tracks

gray
408 – 20 × 0.34 + 3 × 0.75 mm²

3 Cable Length

3.0 m	0300
5.0 m	0500
10.0 m	1000
15.0 m	1500
20.0 m	2000

Technical Data

Total current	max. 8 A
Temperature range	-20...+80 °C, depending on cable quality

Article No.

The composition of your article number is explained on page 3.1.i

8 0 0 0 – **9 8 7 4 9** – _____

1 Form **2** Cable Type **3** Cable Length

Notes

M12 DISTRIBUTION SYSTEMS (PLASTIC)

For sensors and actuators

– Rear connection

– EN ISO 13849-2

Approvals:  Listed

Exact12 Safety

Rear connection
with potential separation

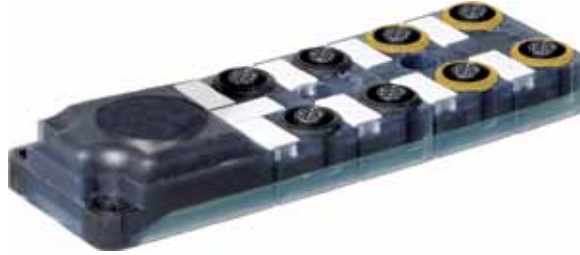

1 Form

98790

Type **PNP, 5-pole, 4/3-pole**
Spring clamp terminals

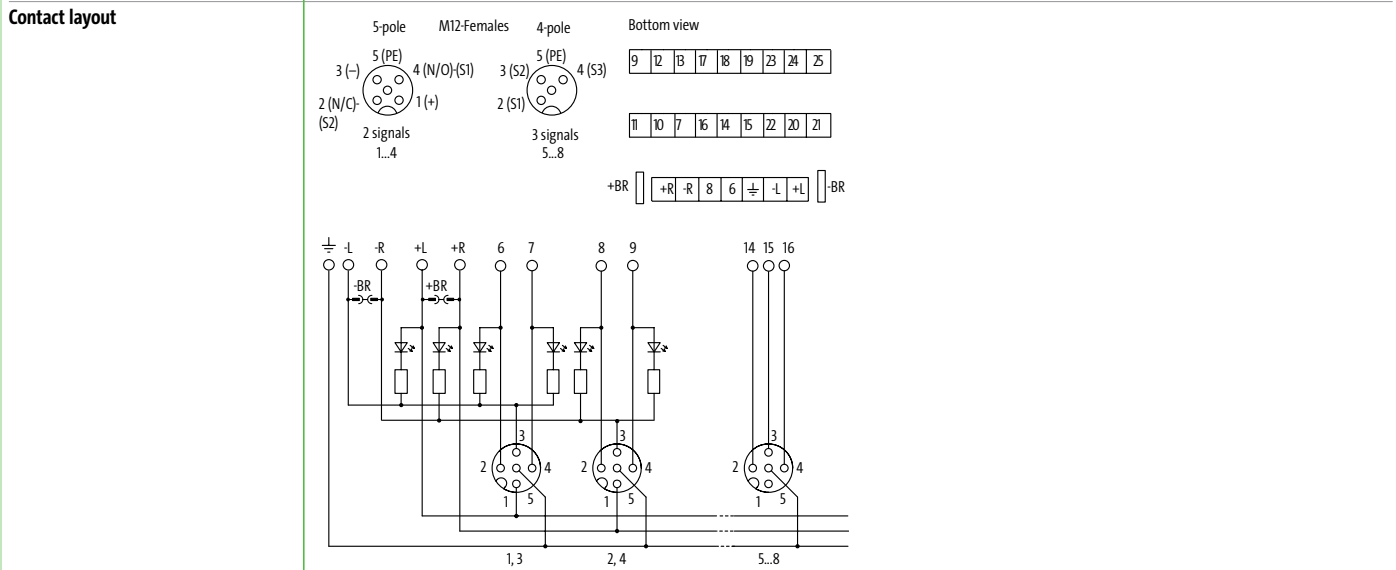

Technical Data

Operating voltage	24 V DC
Operating current per contact	max. 4 A
Total current	max. 8 A
Protection	IP65/IP67
Housing	Plastic, flame retardant
Locking of ports	Screw thread M12 × 1 mm
Temperature range	-20...+60 °C

Contact Layout

LED display	LED (green): Power / LED (yellow): (S1) / LED (white): Signal (S2) port 1...4
PIN 1	(+) port 1...4
PIN 2	(NC)/(S2) port 1...4; (S1) port 5...8
PIN 3	(-) port 1...4; (S2) port 5...8
PIN 4	(NO)/(S1) port 1...4; (S3) port 5...8
PIN 5	(Earth)

Article No.

The composition of your article number is explained on page 3.1.i

8 0 0 0 - 9 8 7 9 0 - 0 0 0 0 0 0 0







1 Form

Notes

M12 DISTRIBUTION SYSTEMS (PLASTIC)

Mounting accessories			Art-No.
	Torque wrench set M12 (0.6 Nm, SW13)	M12 data connenctor molded (standard)	7000-99102-0000000
	Torque wrench M12 (0.6 Nm, SW13)	M12 data connenctor molded (standard)	7000-99109-0000000
	Torque wrench M12 (0.6 Nm, SW14)	M12 data connenctor moulded (Xtreme)	7000-99108-0000000
	Torque wrench M12 (0.6 Nm, SW17)	M12 field-wireable (IDC terminal)	7000-99094-0000000
	Torque wrench M12 (0.6 Nm, SW18)	M12 field-wireable via (screw terminals)	7000-99103-0000000
	DIN-rail adapter with fixing screws, plastic		27905
	V2A guard Exact12 ATEX, 4-way	for 8099-84510-448xxxx	996082
	V2A guard Exact12 ATEX, 8-way	for 8099-88510-452xxxx	996083
Plug accessories			Art-No.
	Transfer module for 1 × 11- and 1 × 12-pole spring clamp terminals		596154
	Service adapter with LED and SUB-D25	for transfer module Art-No. 596154	596153

M12 DISTRIBUTION SYSTEMS (PLASTIC)

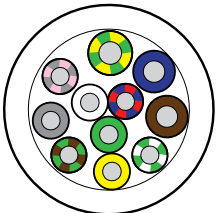
Plug accessories			Art-No.
	Screw plug M12 x 1 mm Metal, hex, 1 piece		996049
	Screw plug M12 x 1 mm (for female) Plastic, hex without gasket	Quantity: 10 pcs.	58627
	Label plates KES 20 x 8 (white)	(10 pieces/2 plates)	996067
	Label plates KES 17 x 9 (Type M) (12 pieces/2 plates)		996050
	Adapter M8/M12 3-pole	M12 Distribution Systems	7000-42201-000000
	Adapter M8/M12 4-pole	M12 Distribution Systems	7000-42211-000000
Homerun cable accessories			Art-No.
	Coding element for 6 codings		996054
	Screw plug M23 Metal		55352
	Screw plug M12 x 1 mm (for male) Plastic	Quantity: 4 pcs.	56951
	Cable rings (50 m), 5-pole, PUR/PVC 8x0.34 + 3x0.75 mm ²	4-way distribution boxes M12	8000-00000-3635000
	12x0.34 + 3x0.75 mm ²	6-way distribution boxes M12	8000-00000-3885000
	16x0.34 + 3x0.75 mm ²	8-way distribution boxes M12	8000-00000-3985000

M12 DISTRIBUTION SYSTEMS (PLASTIC)

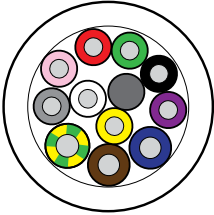
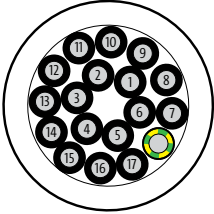
Homerun cable accessories				Art-No.
	Cable rings (50 m), 4-pole, PUR (UL/CSA), halogen free			
		8×0.5 + 3×1.0 mm ²	8-way distribution boxes M12	8000-00000-4475000
		8×0.5 + 3×1.0 mm ²	4-way distribution boxes M12	8000-00000-4485000
		16×0.5 + 3×1.0 mm ²	8-way distribution boxes M12	8000-00000-4525000
		16×0.34 + 5×0.75 mm ²	8-way distribution boxes M12, potentially separated	8000-00000-4035000
	Cable rings (50 m), PUR/PVC			
		18 × 0.75 mm ²	4-way distribution box M12, UNIVERSAL	8000-00000-5335000
		4×0.34 + 3×0.75 mm ²	4-way distribution boxes M12	8000-00000-3335000
		8×0.34 + 3×0.75 mm ²	8-way distribution boxes M12	8000-00000-3625000
		8×0.34 + 5×0.75 mm ²	4-way distribution boxes M12, potentially separated	8000-00000-3745000
		16×0.34 + 5×0.75 mm ²	8-way distribution boxes M12, potentially separated	8000-00000-4045000

M12 DISTRIBUTION SYSTEMS (PLASTIC)

M12 Distribution Systems Technical Data

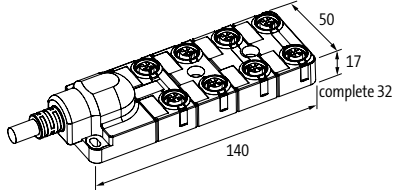
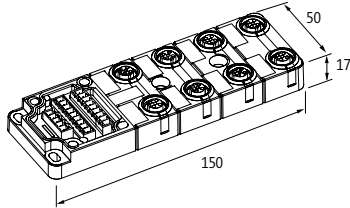
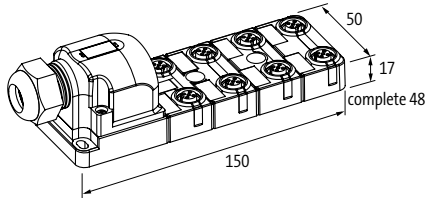
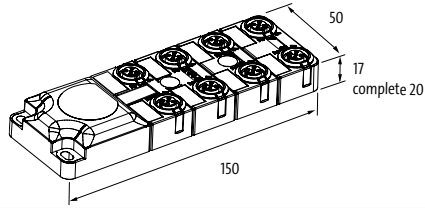
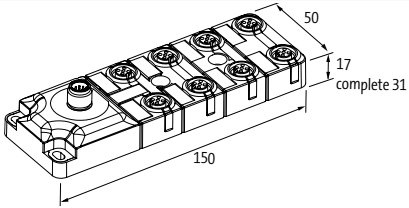
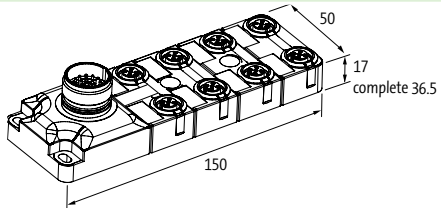
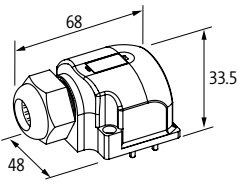
	Description	4-way	8-way
	Exact12 Molded homerun cable	90 mm	140 mm
	Exact12 Basic module	100 mm	150 mm
	Exact12 and MSDS8 Sets: basic module and cap Field-wireable	100 mm	150 mm
	Exact12 Rear connection	100 mm	150 mm
	Exact12 M12 plug connection	100 mm	150 mm
	Exact12 M23 plug connection	100 mm	150 mm
	Exact12 Caps		

Art.-No., page	Art.-No., page	Art.-No., page	Art.-No., page	Art.-No., page
5-digit Art.-No.				
10415, 1.7.2	20103, 1.8.11	23163, 1.8.16	26619, 1.8.11	52003, 1.9.6
10416, 1.7.2	20680, 1.8.10	23164, 1.8.16	26720, 1.8.10	52004, 1.9.7
10460, 1.7.3	20682, 1.8.10	23170, 1.8.13	26722, 1.8.10	52005, 1.9.6
10461, 1.7.3	20683, 1.8.10	23171, 1.8.13	26723, 1.8.10	52015, 1.9.4
10462, 1.7.3	20687, 1.8.10	23172, 1.8.13	26724, 1.8.10	52030, 1.9.5
10463, 1.7.3	20688, 1.8.10	23173, 1.8.13	27905, 4.12.10, 4.13.35	52031, 1.9.8
10464, 1.7.3	21054, 1.8.4	23174, 1.8.13	50010, 1.10.13	52040, 1.9.5
10466, 1.7.3	21060, 1.8.7	23175, 1.8.13	50015, 1.10.16	52041, 1.9.8
10470, 1.7.4	21063, 1.8.7	23180, 1.8.16	50030, 1.10.23	52050, 1.9.4
10471, 1.7.4	21070, 1.8.7	23181, 1.8.16	50034, 1.10.22	52102, 1.9.9
10472, 1.7.4	21071, 1.8.7	23220, 1.8.15	50040, 1.10.12	52103, 1.9.9
10510, 1.7.5	21172, 1.8.1	26001, 1.8.10	50041, 1.10.12	52104, 1.9.10
10511, 1.7.5	21173, 1.8.1	26013, 1.8.3	50043, 1.10.16	52106, 1.9.10
10512, 1.7.5	22050, 1.8.9	26014, 1.8.3	50044, 1.10.16	52110, 1.9.9
10513, 1.7.5	22051, 1.8.9	26015, 1.8.3	50070, 1.10.13	52111, 1.9.9
10531, 1.7.7	22052, 1.8.9	26020, 1.8.11	50080, 1.10.14	52130, 1.9.9
10532, 1.7.7	22054, 1.8.9	26034, 1.8.9	50081, 1.10.14	52136, 1.9.9
10533, 1.7.7	23000, 1.8.15	26036, 1.8.9	50082, 1.10.15	52140, 1.9.9
10534, 1.7.7	23001, 1.8.15	26038, 1.8.9	50085, 1.10.15	52146, 1.9.9
10535, 1.7.7	23002, 1.8.15	26039, 1.8.9	50092, 1.10.23	52160, 1.9.11
10537, 1.7.7	23003, 1.8.15	26051, 1.8.9	50105, 1.10.12	52500, 1.10.5
10538, 1.7.7	23004, 1.8.15	26073, 1.8.10	50110, 1.10.14	52501, 1.10.3
10539, 1.7.7	23005, 1.8.15	26079, 1.8.1	50140, 1.10.17	52502, 1.10.2
10550, 1.7.8	23006, 1.8.15	26086, 1.8.4	51100, 1.9.15	52503, 1.10.9
10551, 1.7.8	23007, 1.8.15	26090, 1.8.11	51108, 1.9.15	52505, 1.10.3
10552, 1.7.8	23009, 1.8.15	26095, 1.8.11	51120, 1.9.15	52506, 1.10.6
10553, 1.7.8	23011, 1.8.12	26097, 1.8.11	51125, 1.9.15	52507, 1.10.6
10554, 1.7.8	23015, 1.8.15	26120, 1.8.10	51130, 1.9.16	52508, 1.10.7
10555, 1.7.8	23016, 1.8.15	26130, 1.8.11	51138, 1.9.16	52510, 1.10.8
10556, 1.7.8	23017, 1.8.15	26150, 1.8.11	51140, 1.9.16	52511, 1.10.9
10571, 1.7.6	23018, 1.8.15	26155, 1.8.11	51300, 1.9.18	52512, 1.10.8
10572, 1.7.6	23022, 1.8.12	26180, 1.8.10	51301, 1.9.18	52513, 1.10.11
10574, 1.7.6	23035, 1.8.12	26181, 1.8.10	51302, 1.9.18	52515, 1.10.2
10575, 1.7.6	23043, 1.8.12	26182, 1.8.10	51403, 1.9.19	52519, 1.10.4
10577, 1.7.6	23050, 1.8.12	26183, 1.8.10	51410, 1.9.17	52520, 1.10.4
10578, 1.7.6	23050, 1.8.12	26184, 1.8.10	51412, 1.9.17	52521, 1.10.5
10701, 1.7.1	23056, 1.8.12	26277, 1.8.1	51413, 1.9.17	52550, 1.10.18
20001, 1.8.10	23100, 1.8.12	26278, 1.8.1	51465, 1.9.17	52551, 1.10.18
20002, 1.8.10	23102, 1.8.12	26283, 1.8.9	51485, 1.9.17	52556, 1.10.20
20004, 1.8.10	23103, 1.8.12	26317, 1.8.9	51508, 1.9.13	52557, 1.10.20
20007, 1.8.3	23104, 1.8.12	26400, 1.8.5	51515, 1.9.13	52561, 1.10.21
20008, 1.8.3	23106, 1.8.12	26401, 1.8.5	51517, 1.9.14	52571, 1.10.19
20009, 1.8.3	23115, 1.8.12	26403, 1.8.5	51526, 1.9.14	52572, 1.10.10
20010, 1.8.10	23118, 1.8.12	26404, 1.8.5	51540, 1.9.17	54500, 4.5.1
20011, 1.8.10	23141, 1.8.13	26440, 1.8.1	51551, 1.9.13	54501, 4.5.1
20012, 1.8.10	23142, 1.8.13	26476, 1.8.7	51552, 1.9.13	54502, 4.5.2
20013, 1.8.10	23144, 1.8.13	26481, 1.8.7	51560, 1.9.14	54503, 4.5.2
20014, 1.8.10	23145, 1.8.13	26530, 1.8.9	51562, 1.9.13	54504, 4.5.3
20031, 1.8.11	23146, 1.8.13	26576, 1.8.9	51571, 1.9.14	54505, 4.5.4
20032, 1.8.11	23147, 1.8.13	26578, 1.8.9	51808, 1.9.12	54506, 4.5.4
20033, 1.8.11	23149, 1.8.13	26588, 1.8.9	51851, 1.9.12	55033, 4.10.1
20034, 1.8.11	23151, 1.8.16	26613, 1.8.11	51860, 1.9.14	55034, 4.10.1
20100, 1.8.11	23157, 1.8.16	26614, 1.8.11	52000, 1.9.4	55035, 4.10.1
20101, 1.8.11	23160, 1.8.16	26615, 1.8.11	52001, 1.9.4	55036, 4.10.1
20102, 1.8.11	23161, 1.8.16	26616, 1.8.11	52002, 1.9.4	55037, 4.10.1

INDEX

Art.-No., page	Art.-No., page	Art.-No., page	Art.-No., page	Art.-No., page
55038, 4.10.2	55390, 4.4.17	56078, 4.2.11	56446, 4.9.3	56691, 4.1.13
55059, 4.10.4	55468, 4.10.7	56079, 4.2.11	56447, 4.9.6	56700, 4.1.17
55060, 4.10.4	55518, 4.7.8	56080, 4.2.11	56448, 4.9.7	56701, 4.1.17
55061, 4.10.5	55519, 4.7.8	56081, 4.2.11	56450, 4.2.3	56710, 4.1.19
55062, 4.10.5	55528, 4.4.7	56082, 4.2.12	56453, 4.10.4	56711, 4.1.19
55071, 4.6.10	55529, 4.4.7	56083, 4.2.12	56454, 4.10.2	56720, 4.1.19
55072, 4.6.10	55530, 4.4.10	56084, 4.2.11	56455, 4.10.7	56721, 4.1.19
55073, 4.6.10	55531, 4.4.11	56085, 4.2.11	56458, 4.8.1	56730, 4.1.17
55074, 4.6.10	55532, 4.4.11	56109, 4.2.11	56462, 4.9.4	56731, 4.1.17
55075, 4.6.9	55542, 4.4.14	56110, 4.2.11	56469, 4.8.1	56740, 4.1.18
55076, 4.6.9	55543, 4.4.15	56111, 4.2.11	56470, 4.8.1	56741, 4.1.18
55077, 4.6.9	55544, 4.4.15	56112, 4.2.5	56471, 4.8.1	56748, 4.1.18
55078, 4.6.9	55550, 2.5.1	56113, 4.2.11	56473, 4.8.1	56749, 4.1.18
55081, 4.6.8	55554, 4.4.18	56117, 4.2.6	56474, 4.9.7	56750, 4.1.15
55082, 4.6.8	55556, 4.4.13	56118, 4.2.7	56475, 4.8.3	56761, 4.1.16
55083, 4.6.8	55557, 4.4.13	56140, 4.2.4	56476, 4.8.3	56766, 4.1.14
55084, 4.6.8	55562, 4.4.12	56168, 4.2.5	56477, 4.8.3	56945, 4.1.32
55085, 4.6.5	55563, 4.4.12	56200, 4.2.8	56478, 4.8.3	56946, 4.1.32
55086, 4.6.5	55575, 4.10.1	56220, 4.2.10	56521, 4.1.1	56947, 4.1.32
55087, 4.6.5	55583, 4.2.11, 4.3.14	56230, 4.2.9	56526, 4.1.1	56948, 4.1.32
55088, 4.6.5	55584, 3.6.36	56240, 4.2.9	56527, 4.1.2	56949, 4.1.32
55089, 4.6.6	55584, 4.2.11, 4.3.14	56400, 4.9.2	56535, 4.1.2	56951, 4.1.30, 4.11.15, 4.13.36
55091, 4.6.2	55585, 3.6.36	56401, 4.9.2	56600, 4.1.7	56952, 4.1.30, 4.10.7
55092, 4.6.2	55585, 4.2.11, 4.3.14	56404, 4.9.2	56601, 4.1.9	56953, 4.1.31
55093, 4.6.2	55586, 3.6.37	56405, 4.9.1	56602, 4.1.4	56955, 4.1.31
55094, 4.6.2	55586, 4.2.11, 4.3.14	56406, 4.9.2	56603, 4.1.5	56960, 4.1.31
55099, 4.4.14	55587, 4.2.11, 4.3.14	56408, 4.9.2	56605, 4.1.20	56961, 4.1.31
55130, 4.6.3	55588, 4.2.11, 4.3.14	56412, 4.10.2	56606, 4.1.6	56962, 4.1.31, 4.10.6
55131, 4.6.4	55604, 4.10.1, 4.10.4	56413, 4.9.2	56610, 4.1.8	56963, 4.1.31, 4.10.6
55132, 4.6.4	55605, 4.10.1	56414, 4.9.2	56611, 4.1.9	56965, 4.1.31
55142, 4.6.6	55606, 4.10.1	56415, 4.9.3	56612, 4.1.4	56968, 4.1.3
55143, 4.6.7	55607, 4.10.1	56416, 4.10.2	56613, 4.1.5	57018, 4.4.16
55144, 4.6.7	55611, 4.10.1	56418, 4.9.4	56616, 4.1.6	57101, 4.3.1
55254, 4.4.6	55680, 4.9.1	56419, 4.9.4	56620, 4.1.8	57103, 4.3.2
55255, 4.4.6	55681, 4.9.1	56420, 4.9.4	56621, 4.1.10	57104, 4.3.3
55274, 4.4.2	55682, 4.9.1	56421, 4.9.5	56622, 4.1.4	57105, 4.3.2
55283, 4.4.8	55696, 4.10.3	56422, 4.9.6	56623, 4.1.5	57106, 4.3.1
55290, 4.4.2	55700, 4.8.2	56423, 4.9.6	56625, 4.1.11	57108, 4.3.3
55291, 4.4.3	55701, 4.8.2	56424, 4.9.5	56626, 4.1.6	57120, 4.3.4
55292, 4.4.4	55727, 4.10.3	56425, 4.9.5	56627, 4.1.11	57121, 4.3.4
55293, 4.4.5	55741, 4.10.2, 4.10.4	56426, 4.9.5	56631, 4.1.10	57122, 4.3.4
55307, 4.4.1	55742, 4.10.4	56427, 4.9.6	56640, 4.1.7	57130, 4.3.5
55308, 4.4.1	55743, 4.10.5	56428, 4.9.6	56641, 4.1.12	57131, 4.3.5
55309, 4.4.1	55744, 4.10.5	56432, 4.10.5	56642, 4.1.12	57190, 4.3.14
55316, 4.1.30	55746, 4.10.5	56433, 4.10.5	56650, 4.1.27	57191, 4.3.14
55317, 4.4.17	55749, 4.10.2, 4.10.4	56434, 4.9.3	56651, 4.1.23	57220, 4.3.6
55318, 4.1.30, 4.4.17, 4.5.5, 4.6.11, 4.7.10, 4.10.7	55760, 3.6.36	56435, 4.9.3	56653, 4.1.28	57230, 4.3.12
55339, 4.4.9	55760, 4.2.11, 4.3.14	56436, 4.9.4	56655, 4.1.23	57231, 4.3.11
55345, 4.6.1	55762, 3.6.36	56438, 4.9.6	56656, 4.1.23	57232, 4.3.11
55346, 4.6.1	55762, 4.2.11, 4.3.14	56439, 4.9.5	56657, 4.1.28	57233, 4.3.11
55347, 4.6.1	55779, 4.10.3	56440, 4.8.3	56661, 4.1.24	57240, 4.3.6
55348, 4.6.1	56001, 4.2.1	56442, 4.9.7	56662, 4.1.25	57261, 4.3.11
55352, 4.4.17, 4.12.11, 4.13.36	56005, 4.2.2	56443, 4.9.5	56663, 4.1.26	57262, 4.3.11
55385, 4.1.30, 4.6.11	56006, 4.2.1	56444, 4.9.5	56671, 4.1.25	57263, 4.3.11
	56077, 4.2.11	56445, 4.9.3	56681, 4.1.13	57265, 4.3.12

Art.-No., page	Art.-No., page	Art.-No., page	Art.-No., page	Art.-No., page
57280, 4.3.6	85131, 1.2.16	85644, 1.2.13	86154, 1.1.6	86485, 1.1.5
57290, 4.3.7	85132, 1.2.16	85650, 1.5.2	86155, 1.1.6	86486, 1.1.5
57320, 4.3.8	85133, 1.2.16	85655, 1.5.1	86157, 1.1.6	87011, 1.2.18
57325, 4.3.9	85135, 1.2.17	85656, 1.5.1	86306, 1.1.4	87012, 1.2.19
57327, 4.3.9	85137, 1.2.17	85657, 1.5.1	86307, 1.1.4	87013, 1.2.18
57331, 4.3.13	85148, 1.2.20	85658, 1.5.1	86308, 1.1.4	87014, 1.2.19
57333, 4.3.13	85349, 1.1.10	85659, 1.5.1	86309, 1.1.4	87015, 1.2.18
57340, 4.3.8	85350, 1.1.10	85660, 1.5.2	86310, 1.1.4	87016, 1.2.19
57345, 4.3.9	85351, 1.1.10	85676, 1.2.9	86311, 1.1.4	87017, 1.2.18
57361, 4.3.13	85352, 1.1.11	85690, 1.2.5	86326, 1.1.4	87018, 1.2.19
57363, 4.3.13	85353, 1.1.11	85691, 1.2.5	86327, 1.1.4	87111, 1.2.18
57380, 4.3.8	85354, 1.1.11	85692, 1.2.6	86328, 1.1.4	87112, 1.2.19
57390, 4.3.10	85355, 1.1.9	85693, 1.2.6	86329, 1.1.4	87113, 1.2.18
58151, 1.11.1	85356, 1.1.9	85695, 1.2.5	86330, 1.1.4	87114, 1.2.19
58152, 1.11.1	85357, 1.1.10	85696, 1.2.5	86331, 1.1.4	87115, 1.2.18
58160, 1.11.3	85360, 1.1.8	85697, 1.2.6	86340, 1.1.1	87116, 1.2.19
58161, 1.11.3	85361, 1.1.8	85698, 1.2.6	86341, 1.1.1	87117, 1.2.18
58170, 1.11.1	85362, 1.1.8	85700, 1.5.3	86342, 1.1.1	87118, 1.2.19
58171, 1.11.1	85363, 1.1.8	85702, 1.2.1	86343, 1.1.1	87690, 1.2.5
58172, 1.11.2	85364, 1.1.9	85703, 1.2.1	86345, 1.1.1	87691, 1.2.5
58173, 1.11.2	85381, 4.8.4	85704, 1.2.1	86346, 1.1.1	87692, 1.2.6
58181, 1.11.4	85382, 4.8.4	85710, 1.5.3	86347, 1.1.1	87693, 1.2.6
58182, 1.11.4	85383, 1.2.7	85712, 1.2.3	86348, 1.1.1	89550, 1.3.8
58183, 1.11.5	85383, 4.8.4	85722, 1.2.2	86349, 1.1.1	89552, 1.3.8
58184, 1.11.7	85394, 1.3.5	85723, 1.2.2	86351, 1.1.1	89553, 1.3.8
58185, 1.11.6	85396, 1.3.7	85724, 1.2.2	86360, 1.1.2	89554, 1.3.8
58186, 1.11.6	85400, 1.1.12	85730, 1.5.3	86361, 1.1.2	89555, 1.3.8
58627, 4.1.30, 4.5.5, 4.6.11, 4.7.10, 4.10.7, 4.13.36	85401, 1.1.12	85921, 1.1.13	86362, 1.1.2	90901, 1.9.28, 1.10.24
59401, 4.7.9	85402, 1.1.12	85923, 1.1.13	86363, 1.1.2	90931, 1.9.28, 1.10.24
59402, 4.7.9	85403, 1.1.12	85925, 1.1.13	86365, 1.1.2	90931, 4.5.5
59450, 4.7.7	85404, 1.1.12	85927, 1.1.13	86366, 1.1.2	90960, 1.9.28, 1.10.24
59451, 4.7.7	85405, 1.1.12	85929, 1.1.13	86367, 1.1.2	90961, 1.9.28, 1.10.24
59452, 4.7.10	85414, 1.3.1	85931, 1.1.13	86368, 1.1.2	90970, 1.9.28, 1.10.24
69000, 2.5.1	85415, 1.3.1	85933, 1.1.13	86369, 1.1.2	90971, 1.9.28, 1.10.24
69001, 2.5.1	85434, 1.2.3	85935, 1.1.13	86371, 1.1.2	90975, 1.9.28, 1.10.24
69002, 2.5.1	85437, 1.2.2	85937, 1.1.13	86450, 1.1.7	90976, 1.9.28, 1.10.24
69003, 2.5.1	85438, 1.2.2	85939, 1.1.13	86451, 1.1.7	90977, 1.9.29, 1.10.25
69004, 2.5.1	85439, 1.2.2	85953, 1.1.13	86452, 1.1.7	90980, 1.9.28, 1.10.24
69010, 2.5.1	85440, 1.2.1	85954, 1.1.13	86453, 1.1.7	90982, 1.9.28, 1.10.24
69011, 2.5.1	85441, 1.2.1	85955, 1.1.13	86454, 1.1.7	
69012, 2.5.1	85442, 1.2.1	85956, 1.1.13	86455, 1.1.7	
69013, 2.5.1	85449, 1.2.4	85957, 1.1.13	86456, 1.1.7	
69040, 2.5.1	85458, 1.3.2	86140, 1.1.3	86463, 1.1.5	
69041, 2.5.1	85459, 1.3.2	86141, 1.1.3	86464, 1.1.5	
69042, 2.5.1	85460, 1.3.3	86142, 1.1.3	86465, 1.1.5	
69043, 2.5.1	85462, 1.3.3	86143, 1.1.3	86466, 1.1.5	
85000, 1.2.10	85467, 1.3.4	86144, 1.1.3	86470, 1.1.7	
85001, 1.2.10	85468, 1.3.4	86145, 1.1.6	86471, 1.1.7	
85002, 1.2.11	85469, 1.3.4	86146, 1.1.6	86472, 1.1.7	
85004, 1.2.11	85495, 1.3.6	86147, 1.1.6	86473, 1.1.7	
85009, 1.2.14	85496, 1.3.6	86148, 1.1.6	86474, 1.1.7	
85010, 1.2.14	85600, 1.5.2	86150, 1.1.6	86475, 1.1.7	
85011, 1.2.14	85640, 1.2.12	86151, 1.1.6	86476, 1.1.7	
85016, 1.2.15	85641, 1.2.12	86152, 1.1.6	86483, 1.1.5	
	85642, 1.2.13	86153, 1.1.6	86484, 1.1.5	

INDEX

Art.-No., page	Art.-No., page	Art.-No., page	Art.-No., page	Art.-No., page
6-digit Art.-No.	7-digit Art.-No.			
230563, 1.8.15	3124015, 1.8.17	5665111, 4.1.29	6652040, 1.9.5	6686361, 1.1.2
233463, 1.8.15	3124016, 1.8.17	5665112, 4.1.29	6652041, 1.9.8	6686362, 1.1.2
236082, 1.8.15	3124017, 1.8.17	5665113, 4.1.29	6652050, 1.9.4	6686363, 1.1.2
236139, 1.8.14	3124018, 1.8.17	5665114, 4.1.29	6652102, 1.9.9	6686365, 1.1.2
236141, 1.8.14	3124021, 1.8.17	5665115, 4.1.29	6652103, 1.9.9	6686366, 1.1.2
236142, 1.8.14	3124033, 1.8.17	5665116, 4.1.29	6652104, 1.9.10	6686367, 1.1.2
236148, 1.8.14	3124046, 1.8.17	5665118, 4.1.29	6652106, 1.9.10	6686368, 1.1.2
236149, 1.8.14	3124048, 1.8.17	5665119, 4.1.29	6652110, 1.9.9	6686369, 1.1.2
512498, 1.9.19	3124049, 1.8.17	5665120, 4.1.29	6652111, 1.9.9	6686371, 1.1.2
512764, 1.9.13	3124052, 1.8.17	5665151, 4.1.29	6652130, 1.9.9	8985349, 1.1.10
516014, 1.9.16	3124063, 1.8.17	5665500, 4.1.29	6652136, 1.9.9	8985350, 1.1.10
526071, 1.10.10	3124064, 1.8.17	5665501, 4.1.29	6652140, 1.9.9	8985351, 1.1.10
526100, 1.10.10	3124068, 1.8.17	5665502, 4.1.29	6652146, 1.9.9	8985360, 1.1.8
553260, 4.4.17	3124070, 1.8.17	5665503, 4.1.26	6652500, 1.10.5	8985361, 1.1.8
556510, 4.8.2	3124071, 1.8.17	5665600, 4.1.29	6652501, 1.10.3	8985362, 1.1.8
556511, 4.8.2	3124072, 1.8.17	5665601, 4.1.29	6652502, 1.10.2	
556613, 4.9.1	3124115, 1.8.18	5665602, 4.1.29	6652503, 1.10.9	
556614, 4.9.1	3124116, 1.8.18	5665603, 4.1.29	6652505, 1.10.3	
556625, 4.8.2	3124121, 1.8.18	5665604, 4.1.29	6652506, 1.10.6	
556639, 4.8.2	3124133, 1.8.18	5665605, 4.1.29	6652507, 1.10.6	
564201, 4.9.4	3124148, 1.8.18	5665606, 4.1.29	6652508, 1.10.7	
564501, 4.2.3	3124163, 1.8.18	5665607, 4.1.29	6652510, 1.10.8	
596153, 4.13.35	3124169, 1.8.18	5665609, 4.1.29	6652511, 1.10.9	
596154, 4.13.35	3124170, 1.8.18	5665610, 4.1.29	6652512, 1.10.8	
996049, 4.4.17, 4.12.10, 4.13.36	3124215, 1.8.17	5665611, 4.1.29	6652513, 1.10.11	
996050, 4.13.36	3124216, 1.8.17	5665613, 4.1.29	6652515, 1.10.2	
996054, 4.13.36	3124221, 1.8.17	5665614, 4.1.29	6652519, 1.10.4	
996064, 4.12.10	3124233, 1.8.17	5665615, 4.1.29	6652520, 1.10.4	
996065, 4.12.10	3124248, 1.8.17	5665616, 4.1.29	6652521, 1.10.5	
996066, 4.12.10	3124249, 1.8.17	5665617, 4.1.29	6652550, 1.10.18	
996067, 1.2.20, 1.4.14	3124263, 1.8.17	5665618, 4.1.29	6652551, 1.10.18	
996067, 4.11.15, 4.12.11, 4.13.36	3124269, 1.8.17	5665619, 4.1.29	6652556, 1.10.20	
996078, 1.4.14	3124811, 1.8.18	5665621, 4.1.29	6652557, 1.10.20	
996082, 4.13.35	3124815, 1.8.18	5666100, 4.1.24	6652561, 1.10.21	
996083, 4.13.35	3124832, 1.8.18	5666200, 4.1.25	6652571, 1.10.19	
	3124833, 1.8.18	5666201, 4.1.26	6652572, 1.10.10	
	3124871, 1.8.18	5667100, 4.1.29	6686306, 1.1.4	
	3124873, 1.8.18	5667101, 4.1.29	6686307, 1.1.4	
	3124875, 1.8.18	5667102, 4.1.29	6686308, 1.1.4	
	3858627, 4.1.30, 4.10.7, 4.11.15	5667103, 4.1.29	6686309, 1.1.4	
	5652701, 4.1.2	5667104, 4.1.29	6686310, 1.1.4	
	5660160, 4.1.22	5667105, 4.1.29	6686311, 1.1.4	
	5661160, 4.1.22	5667106, 4.1.29	6686326, 1.1.4	
	5665000, 4.1.28	5668100, 4.1.13	6686327, 1.1.4	
	5665001, 4.1.28	5676660, 4.1.21	6686340, 1.1.1	
	5665002, 4.1.28	6650140, 1.10.17	6686341, 1.1.1	
	5665003, 4.1.27	6652000, 1.9.4	6686342, 1.1.1	
	5665004, 4.1.28	6652001, 1.9.4	6686343, 1.1.1	
	5665100, 4.1.29	6652002, 1.9.4	6686345, 1.1.1	
	5665101, 4.1.29	6652003, 1.9.6	6686346, 1.1.1	
	5665102, 4.1.29	6652004, 1.9.7	6686347, 1.1.1	
	5665103, 4.1.29	6652005, 1.9.6	6686348, 1.1.1	
	5665105, 4.1.29	6652015, 1.9.4	6686349, 1.1.1	
	5665106, 4.1.29	6652030, 1.9.5	6686351, 1.1.1	
	5665110, 4.1.29	6652031, 1.9.8	6686360, 1.1.2	

Art.-No., page	Art.-No., page	Art.-No., page	Art.-No., page	Art.-No., page
12-digit Art.-No.	14-digit Art.-No.	17-digit Art.-No.	18-digit Art.-No.	
M1850-040601, 2.6.1	M1856-24080611, 2.6.2	MVT1820-062406021, 2.6.2	2000-68200-1100000, 1.8.6	2000-69300-2320000, 1.8.7
M1850-040602, 2.6.1	M1856-24080612, 2.6.2	MVT1820-062406022, 2.6.3	2000-68200-1320000, 1.8.6	2000-69300-2420000, 1.8.7
M1850-060601, 2.6.1		MVT1820-062406041, 2.6.2	2000-68200-2420000, 1.8.6	2000-69300-4300000, 1.8.7
M1850-060602, 2.6.1		MVT1820-062406042, 2.6.3	2000-68200-4300000, 1.8.6	2000-69300-4400000, 1.8.7
M1850-080601, 2.6.1		MVT1820-062406061, 2.6.2	2000-68200-4400000, 1.8.6	2000-69300-5200000, 1.8.7
M1850-080602, 2.6.1		MVT1820-062406062, 2.6.3	2000-68200-5320000, 1.8.6	2000-69300-7300000, 1.8.7
M1850-100601, 2.6.1		MVT1821-062406021, 2.6.2	2000-68200-5420000, 1.8.6	2000-69300-7400000, 1.8.7
M1850-100602, 2.6.2		MVT1821-062406022, 2.6.3	2000-68200-7400000, 1.8.6	2000-69400-2320000, 1.8.7
M1851-040601, 2.6.1		MVT1821-062406041, 2.6.2	2000-68300-1100000, 1.8.2	2000-69400-2420000, 1.8.7
M1851-040602, 2.6.1		MVT1821-062406042, 2.6.3	2000-68300-4300000, 1.8.2	2000-69400-4300000, 1.8.7
M1851-060601, 2.6.1		MVT1821-062406061, 2.6.2	2000-68300-4400000, 1.8.2	2000-69400-4400000, 1.8.7
M1851-060602, 2.6.1		MVT1821-062406062, 2.6.3	2000-68400-2010000, 1.8.8	2000-69400-5320000, 1.8.7
M1851-080601, 2.6.1		MVT1825-262406041, 2.6.2	2000-68400-2320000, 1.8.8	2000-69400-5420000, 1.8.7
M1851-080602, 2.6.1		MVT1825-262406042, 2.6.3	2000-68400-2420000, 1.8.8	2000-69400-7300000, 1.8.7
M1851-100601, 2.6.1		MVT1825-262406061, 2.6.2	2000-68400-4300000, 1.8.8	2000-69400-7400000, 1.8.7
M1851-100602, 2.6.2		MVT1825-262406062, 2.6.3	2000-68400-4400000, 1.8.8	3000-16013-3100020, 1.9.1
			2000-68400-4410000, 1.8.8	3000-16013-3100025, 1.9.2
			2000-68400-5320000, 1.8.8	3000-16013-3100030, 1.9.2
			2000-68400-5420000, 1.8.8	3000-16013-3100040, 1.9.3
			2000-68400-7300000, 1.8.8	3000-16023-3100005, 1.9.1
			2000-68400-7400000, 1.8.8	3000-16023-3100022, 1.9.1
			2000-68400-7410000, 1.8.8	3000-16513-3100022, 1.9.2
			2000-68500-1100000, 1.8.8	3000-32512-2100040, 1.10.1
			2000-68500-2320000, 1.8.8	3000-33010-0000000, 1.9.29
			2000-68500-2420000, 1.8.8	3000-33113-1020012, 1.9.20
			2000-68500-2470000, 1.8.8	3000-33113-3020005, 1.9.22
			2000-68500-4300000, 1.8.8	3000-33113-3020012, 1.9.21
			2000-68500-4400000, 1.8.8	3000-33113-3020020, 1.9.23
			2000-68500-4410000, 1.8.8	3000-33113-3020025, 1.9.23
			2000-68500-5320000, 1.8.8	3000-33113-3020030, 1.9.25
			2000-68500-5420000, 1.8.8	3000-33113-3020050, 1.9.26
			2000-68500-7300000, 1.8.8	3000-33113-3020060, 1.9.24
			2000-68500-7400000, 1.8.8	3000-33113-3020065, 1.9.24
			2000-68500-7410000, 1.8.8	3000-33113-3020075, 1.9.27
			2000-68800-2300000, 1.8.5	3000-90000-0300010, 1.9.28
			2000-68800-2320000, 1.8.5	3000-90000-0300020, 1.9.28
			2000-68800-7300000, 1.8.5	4000-68000-0010000, 2.1.2
			2000-69000-2300000, 1.8.5	4000-68000-0020000, 2.1.2
			2000-69100-1100000, 1.8.2	4000-68000-0050000, 2.1.2
			2000-69100-2420000, 1.8.2	4000-68000-0060000, 2.1.3
			2000-69100-4300000, 1.8.2	4000-68000-0070000, 2.1.3
			2000-69100-4400000, 1.8.2	4000-68000-0090000, 2.1.4
			2000-69100-5420000, 1.8.2	4000-68000-0120000, 2.1.3
			2000-69100-7300000, 1.8.2	4000-68000-0160000, 2.1.2
			2000-69100-7400000, 1.8.2	4000-68000-0170000, 2.1.3
			2000-69101-2320000, 1.8.2	4000-68000-0180000, 2.1.3
			2000-69101-4300000, 1.8.2	4000-68000-0190000, 2.1.3
			2000-69200-1100000, 1.8.2	4000-68000-0820000, 2.1.5
			2000-69200-2320000, 1.8.2	4000-68000-0900000, 2.1.8
			2000-69200-2420000, 1.8.2	4000-68000-0910000, 2.1.5
			2000-69200-4300000, 1.8.2	4000-68000-0920000, 2.1.8
			2000-69200-4400000, 1.8.2	4000-68000-0930000, 2.1.8
			2000-69200-5420000, 1.8.2	4000-68000-0940000, 2.1.5
			2000-69200-7400000, 1.8.2	4000-68000-0950000, 2.1.8
			2000-69300-1100000, 1.8.7	4000-68000-0960000, 2.1.5

INDEX

Art.-No., page	Art.-No., page	Art.-No., page	Art.-No., page	Art.-No., page
4000-68000-0970000, 2.1.5	4000-68000-4550001, 2.1.11	4000-68523-0000001, 2.1.1	4000-70403-0100240, 2.2.4	4000-75070-0000920, 2.4.4
4000-68000-0990000, 2.1.5	4000-68000-4570000, 2.1.11	4000-68523-0000003, 2.1.1	4000-70403-0100250, 2.2.4	4000-75070-0000921, 2.4.4
4000-68000-1040000, 2.1.5	4000-68000-4570001, 2.1.11	4000-68524-0000001, 2.1.1	4000-70403-0100260, 2.2.4	4000-75070-0000922, 2.4.5
4000-68000-1110000, 2.1.6	4000-68000-4580000, 2.1.11	4000-68524-0000003, 2.1.1	4000-70403-0100270, 2.2.4	4000-75324-5310000, 2.4.2
4000-68000-1200000, 2.1.6	4000-68000-4580001, 2.1.11	4000-69000-1000000, 2.2.1	4000-70403-0100280, 2.2.4	4000-75330-5310000, 2.4.2
4000-68000-1210000, 2.1.6	4000-68000-4610000, 2.1.12	4000-69000-1040000, 2.2.1	4000-70403-0100290, 2.2.4	4000-75800-0000900, 2.4.6
4000-68000-1220000, 2.1.6	4000-68000-4610001, 2.1.12	4000-69000-1050000, 2.2.1	4000-70403-0100300, 2.2.4	4000-75800-1715004, 2.4.5
4000-68000-1280000, 2.1.8	4000-68000-4610004, 2.1.12	4000-69000-1060000, 2.2.1	4000-70503-0001010, 2.2.4	4000-75800-1715008, 2.4.5
4000-68000-1300000, 2.1.8	4000-68000-4620001, 2.1.9	4000-69000-1080000, 2.2.1	4000-70503-0001020, 2.2.4	4000-75800-1715016, 2.4.5
4000-68000-1310000, 2.1.6	4000-68000-8500000, 2.1.17	4000-69000-1090000, 2.2.2	4000-70503-0001030, 2.2.4	4000-75800-1715024, 2.4.5
4000-68000-1400000, 2.1.8	4000-68000-8510000, 2.1.17	4000-69000-1100000, 2.2.2	4000-70503-0001050, 2.2.4	4000-75800-1715032, 2.4.5
4000-68000-1410000, 2.1.6	4000-68000-8900000, 2.1.16	4000-69000-2000000, 2.2.2	4000-70503-0001060, 2.2.4	4000-75801-1415006, 2.4.5
4000-68000-1420000, 2.1.6	4000-68000-8910000, 2.1.16	4000-69000-2040000, 2.2.2	4000-70503-0100010, 2.2.4	4000-75801-1415012, 2.4.5
4000-68000-1430000, 2.1.7	4000-68000-9000000, 2.1.17	4000-69000-2500000, 2.2.2	4000-70503-0100020, 2.2.4	4000-75801-1415018, 2.4.5
4000-68000-1440000, 2.1.7	4000-68000-9030010, 2.1.16	4000-69000-5200000, 2.2.2	4000-70603-0240120, 2.2.4	4000-75801-1415024, 2.4.5
4000-68000-1450000, 2.1.7	4000-68000-9030011, 2.1.16	4000-69000-9000000, 2.2.2	4000-70603-0240140, 2.2.4	4000-75827-1315000, 2.4.6
4000-68000-1620000, 2.1.7	4000-68000-9030020, 2.1.16	4000-69000-9500050, 2.2.3	4000-70603-0240170, 2.2.4	4000-75900-1715004, 2.4.5
4000-68000-1700000, 2.1.7	4000-68000-9030021, 2.1.16	4000-69000-9500060, 2.2.3	4000-70603-0240220, 2.2.4	4000-75900-1715008, 2.4.5
4000-68000-1800000, 2.1.7	4000-68000-9030040, 2.1.16	4000-69112-0000000, 2.2.1	4000-70603-0240230, 2.2.4	4000-75900-1715016, 2.4.5
4000-68000-1810000, 2.1.7	4000-68000-9030041, 2.1.16	4000-69122-0000000, 2.2.1	4000-70603-0240290, 2.2.4	4000-75900-1715024, 2.4.5
4000-68000-3010000, 2.1.2	4000-68000-9030050, 2.1.16	4000-69212-0000000, 2.2.1	4000-70703-0500040, 2.2.4	4000-75900-1715032, 2.4.5
4000-68000-3210000, 2.1.4	4000-68000-9030051, 2.1.16	4000-69222-0000000, 2.2.1	4000-70703-0500060, 2.2.4	4000-75901-1415006, 2.4.6
4000-68000-3220000, 2.1.2	4000-68000-9030052, 2.1.16	4000-70103-0004000, 2.2.3	4000-70703-0500080, 2.2.4	4000-75901-1415012, 2.4.6
4000-68000-3240000, 2.1.2	4000-68000-9030053, 2.1.16	4000-70103-0008000, 2.2.3	4000-70703-0630080, 2.2.5	4000-75901-1415018, 2.4.6
4000-68000-3250000, 2.1.4	4000-68000-9030054, 2.1.16	4000-70103-0010000, 2.2.3	4000-70703-0630130, 2.2.5	4000-75901-1415024, 2.4.6
4000-68000-3280000, 2.1.3	4000-68000-9030055, 2.1.16	4000-70103-0104000, 2.2.3	4000-70703-0630190, 2.2.5	4000-76050-0000923, 2.4.5
4000-68000-3290000, 2.1.4	4000-68000-9030060, 2.1.16	4000-70103-0106000, 2.2.3	4000-70704-0500000, 2.2.4	4000-76050-1011000, 2.4.1
4000-68000-3310000, 2.1.4	4000-68000-9030061, 2.1.16	4000-70103-0202000, 2.2.3	4000-70704-0630000, 2.2.5	4000-76050-1012000, 2.4.1
4000-68000-4030000, 2.1.9	4000-68000-9030062, 2.1.16	4000-70202-0001000, 2.2.5	4000-70902-0075220, 2.2.5	4000-76050-1013000, 2.4.2
4000-68000-4040000, 2.1.10	4000-68000-9040010, 2.1.15	4000-70202-0002000, 2.2.5	4000-70902-0160450, 2.2.5	4000-76050-1014000, 2.4.2
4000-68000-4100000, 2.1.12	4000-68000-9040011, 2.1.15	4000-70203-0100000, 2.2.5	4000-70902-0180800, 2.2.5	4000-76050-1015000, 2.4.2
4000-68000-4110000, 2.1.13	4000-68000-9040012, 2.1.15	4000-70302-0000010, 2.2.5	4000-70920-0000000, 2.2.5	4000-76050-1100002, 2.4.1
4000-68000-4120000, 2.1.13	4000-68000-9040022, 2.1.15	4000-70302-0000050, 2.2.5	4000-71001-0410003, 4.12.10	4000-76050-1100003, 2.4.1
4000-68000-4130000, 2.1.13	4000-68000-9040030, 2.1.15	4000-70302-0000090, 2.2.5	4000-71001-0410004, 4.1.30, 4.4.17	4000-76050-1100004, 2.4.1
4000-68000-4140000, 2.1.13	4000-68000-9040031, 2.1.15	4000-70403-0001030, 2.2.4	4000-71001-0610004, 2.1.16	4000-76070-0000901, 2.4.4
4000-68000-4300001, 2.1.12	4000-68000-9040032, 2.1.15	4000-70403-0001040, 2.2.4	4000-71001-0620004, 2.1.16	4000-76070-0000902, 2.4.4
4000-68000-4310001, 2.1.12	4000-68000-9040040, 2.1.15	4000-70403-0001050, 2.2.4	4000-71001-0630004, 2.1.16	4000-76070-0000903, 2.4.4
4000-68000-4320001, 2.1.13	4000-68000-9040041, 2.1.15	4000-70403-0001060, 2.2.4	4000-71003-0101403, 4.12.10	4000-76070-0000913, 2.4.4
4000-68000-4330001, 2.1.13	4000-68000-9040042, 2.1.15	4000-70403-0001070, 2.2.4	4000-73000-0010000, 2.1.14	4000-76070-0000918, 2.4.4
4000-68000-4340001, 2.1.13	4000-68000-9040045, 2.1.15	4000-70403-0001080, 2.2.4	4000-73000-0150000, 2.1.14	4000-76070-0000923, 2.4.5
4000-68000-4360001, 2.1.13	4000-68000-9040050, 2.1.16	4000-70403-0001090, 2.2.4	4000-73000-0160000, 2.1.14	4000-76070-1011000, 2.4.1
4000-68000-4390001, 2.1.12	4000-68000-9040051, 2.1.16	4000-70403-0001100, 2.2.4	4000-73000-0170000, 2.1.14	4000-76070-1012000, 2.4.1
4000-68000-4500000, 2.1.9	4000-68000-9060010, 2.1.17	4000-70403-0001110, 2.2.4	4000-73000-0180000, 2.1.14	4000-76070-1013000, 2.4.2
4000-68000-4500001, 2.1.9	4000-68000-9060020, 2.1.17	4000-70403-0001120, 2.2.4	4000-75030-0000903, 2.4.4	4000-76070-1014000, 2.4.2
4000-68000-4500004, 2.1.9	4000-68000-9060030, 2.1.17	4000-70403-0001130, 2.2.4	4000-75057-1111000, 2.4.3	4000-76070-1015000, 2.4.2
4000-68000-4510000, 2.1.9	4000-68000-9140000, 2.1.17	4000-70403-0001140, 2.2.4	4000-75057-1112000, 2.4.3	4000-76070-1100002, 2.4.1
4000-68000-4510001, 2.1.9	4000-68000-9180000, 2.1.17	4000-70403-0001150, 2.2.4	4000-75057-1113000, 2.4.3	4000-76070-1100003, 2.4.1
4000-68000-4520000, 2.1.10	4000-68512-0000001, 2.1.1	4000-70403-0100160, 2.2.4	4000-75057-1114000, 2.4.3	4000-76070-1100004, 2.4.1
4000-68000-4520001, 2.1.10	4000-68512-0000003, 2.1.1	4000-70403-0100170, 2.2.4	4000-75057-1115000, 2.4.3	4000-76070-1300002, 2.4.1
4000-68000-4530000, 2.1.10	4000-68513-0000001, 2.1.1	4000-70403-0100180, 2.2.4	4000-75057-1311000, 2.4.3	4000-76070-1400002, 2.4.1
4000-68000-4530001, 2.1.10	4000-68513-0000003, 2.1.1	4000-70403-0100190, 2.2.4	4000-75057-1312000, 2.4.3	4000-76070-1500002, 2.4.1
4000-68000-4530004, 2.1.10	4000-68514-0000001, 2.1.1	4000-70403-0100200, 2.2.4	4000-75057-1313000, 2.4.3	4000-76501-5310000, 2.4.2
4000-68000-4540000, 2.1.11	4000-68514-0000003, 2.1.1	4000-70403-0100210, 2.2.4	4000-75057-1314000, 2.4.3	4000-76502-5310000, 2.4.2
4000-68000-4540001, 2.1.11	4000-68522-0000001, 2.1.1	4000-70403-0100220, 2.2.4	4000-75057-1315000, 2.4.3	4000-76704-5310000, 2.4.2
4000-68000-4550000, 2.1.10	4000-68522-0000003, 2.1.1	4000-70403-0100230, 2.2.4	4000-75070-0000904, 2.4.4	4000-76705-5310000, 2.4.2

Art.-No., page	Art.-No., page	Art.-No., page	Art.-No., page	Art.-No., page
4000-76712-5310000, 2.4.2	7000-12861-0000000, 3.2.51	7000-21161-0000000, 3.6.33	7000-41131-0000000, 3.3.3	7000-48116-0000000, 2.6.3
4000-76713-5310000, 2.4.2	7000-12881-0000000, 3.2.51, 3.6.32	7000-29001-0000000, 3.12.27	7000-41131-0000000, 4.10.3	7000-50061-0000000, 3.3.5, 3.10.34
5000-00501-1100000, 4.7.1	7000-12901-0000000, 3.2.47	7000-29005-0000000, 3.12.39	7000-41135-0000000, 3.3.3	7000-50061-0000000, 4.1.31
5000-00501-1110000, 4.7.1	7000-12921-0000000, 3.2.47	7000-29021-0000000, 3.12.27	7000-41141-0000000, 3.3.2	7000-50111-0000000, 3.10.34
5000-00501-1200000, 4.7.2	7000-12931-0000000, 3.2.52	7000-29041-0000000, 3.12.27	7000-41141-0000000, 4.10.2	7000-51521-0000000, 3.4.13
5000-00501-1210000, 4.7.2	7000-12941-0000000, 3.2.48	7000-29061-0000000, 3.12.27	7000-41151-0000000, 3.3.3	7000-51531-0000000, 3.6.33
5000-00501-1300001, 4.7.3	7000-12961-0000000, 3.2.48, 3.6.32	7000-29081-0000000, 3.12.28	7000-41151-0000000, 4.10.2	7000-51541-0000000, 3.6.33
5000-00501-2100000, 4.7.4	7000-12981-0000000, 3.2.50	7000-29085-0000000, 3.12.39	7000-41155-0000000, 4.4.18	7000-74001-0000000, 3.6.32
5000-00501-2110000, 4.7.4	7000-13001-0000000, 3.2.50	7000-29101-0000000, 3.12.28	7000-41161-0000000, 3.3.2	7000-74011-0000000, 3.6.32
5000-00501-2200000, 4.7.5	7000-13011-0000000, 3.2.52	7000-29121-0000000, 3.12.29	7000-41181-0000000, 3.3.2	7000-74021-0000000, 3.6.32
5000-00501-2210000, 4.7.5	7000-13021-0000000, 3.2.51	7000-29141-0000000, 3.12.29	7000-41191-0000000, 3.3.3	7000-74031-0000000, 3.6.32
5000-00501-2300001, 4.7.6	7000-13041-0000000, 3.2.51, 3.6.32	7000-29161-0000000, 3.12.29	7000-41301-0000000, 3.12.23	7000-74041-0000000, 3.6.34
7000-08331-0000000, 3.1.14	7000-13301-0000000, 3.2.54	7000-29165-0000000, 3.12.39	7000-41321-0000000, 3.12.24	7000-74061-0000000, 3.6.35
7000-08351-0000000, 3.1.14	7000-13321-0000000, 3.2.54	7000-29181-0000000, 3.12.29	7000-41421-0000000, 3.12.23	7000-74071-0000000, 3.6.32
7000-08371-0000000, 3.1.14	7000-13341-0000000, 3.2.56	7000-29241-0000000, 3.12.28	7000-41441-0000000, 3.12.24	7000-74075-0000000, 3.6.32
7000-08391-0000000, 3.1.14	7000-13361-0000000, 3.2.56	7000-29245-0000000, 3.12.36	7000-41901-0000000, 3.12.25	7000-74081-0000000, 3.6.32
7000-08552-9700020, 3.1.17	7000-13381-0000000, 3.2.54	7000-29261-0000000, 3.12.28	7000-41961-0000000, 3.12.25	7000-74085-0000000, 3.6.32
7000-08562-9690020, 3.1.17	7000-13401-0000000, 3.2.54	7000-29281-0000000, 3.12.31	7000-42021-0000000, 3.12.26	7000-74091-0000000, 3.6.32
7000-08571-9700020, 3.1.17	7000-13421-0000000, 3.2.56	7000-29301-0000000, 3.12.31	7000-42081-0000000, 3.12.26	7000-74095-0000000, 3.6.32
7000-08581-9710020, 3.1.17	7000-13441-0000000, 3.2.56	7000-29361-0000000, 3.12.32	7000-42111-0000000, 2.2.3	7000-78081-0000000, 3.10.31
7000-08601-0000000, 3.1.13	7000-13461-0000000, 3.6.33	7000-29381-0000000, 3.12.32	7000-42111-0000000, 3.4.12, 3.6.34	7000-78091-0000000, 3.10.33
7000-08611-0000000, 3.1.13	7000-13481-0000000, 4.1.30, 4.4.17	7000-29401-0000000, 3.12.32	7000-42114-0000000, 2.6.3	7000-78101-0000000, 3.10.31
7000-08621-0000000, 3.1.13	7000-13501-9710020, 3.2.58	7000-29405-0000000, 3.12.36	7000-42116-0000000, 2.6.3	7000-78141-0000000, 3.10.31
7000-08631-0000000, 3.1.13	7000-13521-9720020, 3.2.58, 3.6.34	7000-29421-0000000, 3.12.32	7000-42201-0000000, 4.12.11,	7000-78201-0000000, 3.10.32
7000-08641-0000000, 3.1.15	7000-13541-9710020, 3.2.58	7000-29441-0000000, 3.12.31	4.13.36	7000-78211-0000000, 3.10.33
7000-08651-0000000, 3.1.15	7000-13561-9720020, 3.2.58, 3.6.34	7000-29461-0000000, 3.12.31	7000-42211-0000000, 4.12.11,	7000-78221-0000000, 3.10.32
7000-08661-0000000, 3.1.15	7000-14001-0000000, 3.6.31	7000-29481-0000000, 3.12.30	4.13.36	7000-78261-0000000, 3.10.32
7000-08671-0000000, 3.1.15	7000-14011-0000000, 3.6.31	7000-29501-0000000, 3.12.30	7000-42251-0000000, 4.4.17	7000-78301-0000000, 3.6.33
7000-12461-0000000, 3.2.41	7000-14021-0000000, 3.6.31	7000-29521-0000000, 3.12.30	7000-42252-0000000, 4.4.17	7000-78341-9780020, 3.10.34
7000-12481-0000000, 3.2.41	7000-14031-0000000, 3.6.31	7000-29541-0000000, 3.12.30	7000-42771-0000000, 4.7.10	7000-78381-9780020, 3.10.34
7000-12491-0000000, 3.2.42	7000-14041-0000000, 3.6.33	7000-29561-0000000, 3.12.33	7000-44111-0000000, 2.2.3	7000-80081-0000000, 3.12.35
7000-12501-0000000, 3.2.45	7000-14121-9750020, 3.6.34	7000-29565-0000000, 3.12.40	7000-44111-0000000, 3.4.12, 3.6.34	7000-88521-0000000, 4.11.15
7000-12515-0000000, 3.2.45	7000-14161-9750020, 3.6.34	7000-29581-0000000, 3.12.33	7000-44114-0000000, 2.6.3	7000-88531-0000000, 4.11.15
7000-12521-0000000, 3.2.45	7000-14201-0000000, 3.6.31	7000-29601-0000000, 3.12.33	7000-44116-0000000, 2.6.3	7000-88602-0000000, 3.3.1
7000-12541-0000000, 3.2.43	7000-14221-0000000, 3.6.31	7000-29621-0000000, 3.12.33	7000-44151-0000000, 3.6.31	7000-88602-0000000, 4.11.15
7000-12561-0000000, 3.2.43	7000-14501-9760020, 3.6.34	7000-29645-0000000, 3.12.40	7000-44161-0000000, 3.6.31	7000-88611-0000000, 3.3.1
7000-12581-0000000, 3.2.41	7000-14521-0000000, 3.6.31	7000-29685-0000000, 3.12.40	7000-44586-0000000, 2.6.3	7000-88621-0000000, 3.3.1
7000-12601-0000000, 3.2.41	7000-14581-0000000, 3.6.31	7000-29765-0000000, 3.12.37	7000-44611-0000000, 2.2.3	7000-94081-0000000, 3.12.35
7000-12611-0000000, 3.2.42	7000-14621-0000000, 3.6.31	7000-29801-0000000, 3.12.34	7000-44611-0000000, 3.4.13, 3.6.34	7000-99001-0000000, 1.9.28,
7000-12621-0000000, 3.2.46	7000-15041-0000000, 3.6.33	7000-29805-0000000, 3.12.41	7000-44624-0000000, 2.6.3	1.10.24
7000-12641-0000000, 3.2.46	7000-15041-0000000, 4.1.31	7000-29821-0000000, 3.12.34	7000-44671-0000000, 3.6.33	7000-99001-0000000, 3.12.44
7000-12661-0000000, 3.2.43	7000-15701-0000000, 3.6.33	7000-29841-0000000, 3.12.34	7000-44681-0000000, 3.6.33	7000-99002-0000000, 3.1.16, 3.2.57,
7000-12671-0000000, 3.2.44	7000-15711-0000000, 3.6.34	7000-29861-0000000, 3.12.34	7000-46091-0000000, 4.1.30	3.5.7, 3.6.38, 3.7.22
7000-12681-0000000, 3.2.43	7000-17161-9730020, 3.2.58	7000-29885-0000000, 3.12.41	7000-46101-0000000, 3.6.31	7000-99003-0000000, 1.10.24
7000-12691-0000000, 3.2.44	7000-17181-9730020, 3.2.58	7000-29925-0000000, 3.12.41	7000-46101-0000000, 4.1.30	7000-99003-0000000, 3.12.44
7000-12701-0000000, 3.2.47	7000-17301-0000000, 3.2.49	7000-30005-0000000, 3.12.37	7000-46111-0000000, 2.2.3	7000-99004-0000000, 3.1.16, 3.2.57,
7000-12721-0000000, 3.2.47	7000-17311-0000000, 3.2.49	7000-30055-0000000, 3.12.38	7000-46111-0000000, 3.4.12, 3.6.34	3.5.7, 3.6.37, 3.7.22
7000-12731-0000000, 3.2.52	7000-17321-0000000, 3.2.49	7000-30105-0000000, 3.12.42	7000-46111-0000000, 4.1.31	7000-99005-0000000, 3.1.16, 3.2.57,
7000-12741-0000000, 3.2.48	7000-17331-0000000, 3.2.49	7000-30115-0000000, 3.12.42	7000-46114-0000000, 2.6.3	3.5.7, 3.6.38, 3.7.22
7000-12761-0000000, 3.2.48, 3.6.32	7000-17341-0000000, 3.2.55	7000-30125-0000000, 3.12.42	7000-46116-0000000, 2.6.3	7000-99006-0000000, 3.1.16, 3.2.57,
7000-12781-0000000, 3.2.53	7000-17351-0000000, 3.2.55	7000-30155-0000000, 3.12.38	7000-47281-0000000, 3.4.13	3.5.7, 3.6.38, 3.7.22
7000-12801-0000000, 3.2.53	7000-17361-0000000, 3.2.55	7000-30205-0000000, 3.12.43	7000-47301-0000000, 3.3.4	7000-99008-0000000, 3.1.16
7000-12821-0000000, 3.2.50	7000-17371-0000000, 3.2.55	7000-30215-0000000, 3.12.43	7000-47311-0000000, 3.3.4	7000-99011-0000000, 3.12.44
7000-12841-0000000, 3.2.50	7000-21101-0000000, 3.6.33	7000-41121-0000000, 3.3.2	7000-48111-0000000, 3.4.12	7000-99012-0000000, 3.12.44
7000-12851-0000000, 3.2.52	7000-21151-0000000, 3.6.33	7000-41121-0000000, 4.10.3	7000-48114-0000000, 2.6.3	7000-99013-0000000, 3.12.44

INDEX

Art.-No., page	Art.-No., page	Art.-No., page	Art.-No., page	Art.-No., page
7000-99014-0000000, 3.12.44	7000-99221-0000000, 3.12.45	7000-C0201-5880000, 4.10.6	70MH-GSFHQ-B01D000, 2.7.3	70MH-RF045-0000000, 2.7.5
7000-99015-0000000, 3.12.44	7000-99231-0000000, 3.12.45	7000-C0201-7960000, 3.6.36	70MH-GSFHQ-B02D000, 2.7.3	70MH-RG06B-0000000, 2.7.5
7000-99016-0000000, 3.12.44	7000-99235-0000000, 3.12.45	7000-C0201-7980000, 3.6.36	70MH-GSGHQ-B01D000, 2.7.3	70MH-RG06S-0000000, 2.7.5
7000-99017-0000000, 3.12.44	7000-99241-0000000, 3.12.45	7000-C0201-8030000, 3.6.35	70MH-GSGHQ-B02D000, 2.7.3	70MH-ZRJ45-1000000, 2.7.10
7000-99018-0000000, 3.12.44	7000-99245-0000000, 3.12.45	7000-C0201-8400000, 3.6.35	70MH-GTDNL-A01B000, 2.7.1	70MH-ZRJ45-2000000, 2.7.10
7000-99019-0000000, 3.12.44	7000-99251-0000000, 3.12.44	7000-C0201-8620000, 3.6.36	70MH-GTDNL-A02B000, 2.7.1	8000-00000-3335000, 4.13.37
7000-99020-0000000, 3.12.44	7000-99255-0000000, 3.12.44	7000-C9901-1660000, 4.10.5	70MH-GTENQ-A01C000, 2.7.1	8000-00000-3345000, 4.11.15
7000-99021-0000000, 3.12.44	7000-99261-0000000, 3.12.44	7000-C9901-1780000, 4.10.5	70MH-GTENQ-A02C000, 2.7.1	8000-00000-3375000, 4.11.15
7000-99022-0000000, 3.12.44	7000-99271-0000000, 3.12.44	7000-C9901-7790000, 4.10.5	70MH-GTFHQ-A01D000, 2.7.1	8000-00000-3505000, 4.11.16
7000-99023-0000000, 3.12.44	7000-99281-0000000, 3.12.44	7000-C9901-7840000, 4.10.5	70MH-GTFHQ-A02D000, 2.7.1	8000-00000-3565000, 4.11.16
7000-99024-0000000, 3.12.44	7000-99291-0000000, 3.12.44	7000-P4391-0000000, 3.10.9	70MH-GTGHQ-A01D000, 2.7.1	8000-00000-3575000, 4.11.16
7000-99025-0000000, 3.12.44	7000-99301-V011002, 3.1.16, 3.2.57, 3.5.7, 3.7.22	7000-P4421-0000000, 3.10.9	70MH-GTGHQ-A02D000, 2.7.2	8000-00000-3585000, 4.11.16
7000-99026-0000000, 3.12.44	7000-99301-V011018, 3.1.16, 3.2.57, 3.5.7, 3.7.22	7000-P6391-0000000, 3.10.7	70MH-MAA10-0000000, 2.7.5	8000-00000-3595000, 4.11.16
7000-99045-0000000, 3.2.57, 3.7.23	7000-99301-V012008, 3.1.16, 3.2.57, 3.5.7, 3.7.22	7000-P6411-0000000, 3.10.7	70MH-MAB1A-0020703, 2.7.6	8000-00000-3605000, 4.11.16
7000-99061-0000000, 4.7.10, 4.10.2, 4.10.3	7000-99301-V013020, 3.1.16, 3.2.57, 3.5.7, 3.7.22	7000-P7391-0000000, 3.10.8	70MH-MAB1A-0020706, 2.7.6	8000-00000-3625000, 4.13.37
7000-99062-0000000, 3.3.6	7000-99301-V012008, 3.1.16, 3.2.57, 3.5.7, 3.7.22	7000-P7411-0000000, 3.10.8	70MH-MAB1C-0030903, 2.7.7	8000-00000-3635000, 4.13.36
7000-99062-0000000, 4.7.10, 4.10.2, 4.10.3	7000-99301-V013020, 3.1.16, 3.2.57, 3.5.7, 3.7.22	7030-42291-0000000, 4.4.17	70MH-MAB1C-0040603, 2.7.7	8000-00000-3735000, 4.12.11
7000-99063-0000000, 3.3.6	7000-99301-V014003, 3.1.16, 3.2.57, 3.5.7, 3.7.22	7030-42602-0000000, 4.4.18	70MH-MAB1C-0060502, 2.7.8	8000-00000-3745000, 4.13.37
7000-99081-0000000, 3.1.16, 3.2.58, 3.5.7, 3.6.38, 3.7.23, 3.12.45	7000-99301-V014006, 3.1.16, 3.2.57, 3.5.7, 3.7.22	7030-42612-0000000, 4.4.18	70MH-MAB1C-0080402, 2.7.8	8000-00000-3845000, 4.11.16
7000-99091-0000000, 3.1.16	7000-99301-V015005, 3.1.16, 3.2.57, 3.5.7, 3.7.22	7030-42622-0000000, 2.5.2	70MH-MAB1C-0120801, 2.7.9	8000-00000-3855000, 4.11.16
7000-99091-0000000, 4.10.4	7000-99301-V016018, 3.1.16, 3.2.57, 3.5.7, 3.7.22	7050-12461-0000000, 3.5.5	70MH-MAB1C-0170201, 2.7.9	8000-00000-3865000, 4.11.16
7000-99094-0000000, 3.2.57, 3.7.22	7000-99301-V017035, 3.1.16, 3.2.57, 3.5.7, 3.7.22	7050-12481-0000000, 3.5.5	70MH-MAB1C-0200502, 2.7.9	8000-00000-3885000, 4.13.36
7000-99094-0000000, 4.10.3, 4.12.10, 4.13.35	7000-99301-V019003, 3.1.16, 3.2.57, 3.5.7, 3.7.22	7050-12521-0000000, 3.5.6	70MH-MAB1P-0050402, 2.7.8	8000-00000-3895000, 4.11.16
7000-99096-0000000, 3.10.34	7000-99301-V019004, 3.1.16, 3.2.57, 3.5.7, 3.7.22	7050-12581-0000000, 3.5.5	70MH-MAB2A-0010707, 2.7.6	8000-00000-3955000, 4.11.16
7000-99096-0000000, 4.10.4	7000-99401-0000000, 3.6.37	7050-12601-0000000, 3.5.5	70MH-MAB2A-0020704, 2.7.6	8000-00000-3965000, 4.11.16
7000-99097-0000000, 3.10.34	7000-99411-0000000, 3.6.37	7050-12641-0000000, 3.5.6	70MH-MAC1A-0020703, 2.7.7	8000-00000-3985000, 4.13.36
7000-99097-0000000, 4.10.4	7000-99421-0000000, 3.6.37	7060-12221-8620100, 4.10.7	70MH-MAC1A-0020706, 2.7.7	8000-00000-4015000, 4.12.11
7000-99101-0000000, 3.1.16, 3.6.38, 3.7.22	7000-99431-0000000, 3.6.37	7060-40005-5880100, 4.10.6	70MH-MAC1C-0030903, 2.7.7	8000-00000-4035000, 4.12.11, 4.13.37
7000-99101-0000000, 4.10.3, 4.11.15	7000-99441-0000000, 3.6.37	7060-40021-8620100, 4.10.6	70MH-MAC1C-0040603, 2.7.8	8000-00000-4045000, 4.13.37
7000-99102-0000000, 3.2.57, 3.6.38, 3.7.22	7000-99441-0000000, 4.2.11, 4.3.14	7060-40245-5880100, 4.10.6	70MH-MAC1C-0060502, 2.7.8	8000-00000-4115000, 4.11.16
7000-99102-0000000, 4.10.3, 4.12.10, 4.13.35	7000-99591-0000000, 3.6.34	7060-40261-8620100, 4.10.6	70MH-MAC1C-0080402, 2.7.8	8000-00000-4125000, 4.11.16
7000-99103-0000000, 3.2.57, 3.7.22	7000-99601-0000000, 3.6.34	7060-40485-5420100, 4.10.7	70MH-MAC1C-0120801, 2.7.9	8000-00000-415000, 4.11.16
7000-99103-0000000, 4.10.3, 4.12.10, 4.13.35	7000-99661-0000000, 3.6.35	7060-40505-4940100, 4.10.7	70MH-MAC1C-0170201, 2.7.9	8000-00000-4170201, 2.7.9
7000-99104-0000000, 3.10.34	7000-99671-0000000, 3.6.35	7060-42701-0000000, 3.6.31	70MH-MAC1C-0200502, 2.7.9	70MH-MAC1P-0050402, 2.7.8
7000-99104-0000000, 4.10.4	7000-99691-0000000, 3.6.35	7060-42701-0000000, 4.10.6	70MH-MAC2A-0010707, 2.7.6	70MH-MAC2A-0020704, 2.7.7
7000-99105-0000000, 3.10.34	7000-99695-0000000, 3.6.35	7060-42703-0000000, 4.10.6	70MH-MAD2C-0020101, 2.7.7	70MH-MAD2C-0020101, 2.7.7
7000-99107-0000000, 3.7.22	7000-99701-0000000, 3.6.35	70MH-EB006-DP03020, 2.7.4	70MH-MAE2C-0020101, 2.7.7	70MH-MAF2C-0020704, 2.7.7
7000-99108-0000000, 3.7.22	7000-99801-0000000, 3.1.17, 3.2.58, 3.7.23	70MH-EB010-EP03020, 2.7.4	70MH-MAG2C-0020704, 2.7.7	70MH-MAH1C-0000000, 2.7.9
7000-99108-0000000, 4.10.3, 4.12.10, 4.13.35	7000-99811-0000000, 3.2.58, 3.7.23	70MH-EB016-FP03020, 2.7.4	70MH-MAI1C-0000000, 2.7.10	70MH-MAI1C-0000000, 2.7.10
7000-99109-0000000, 3.2.57	7000-99901-0000000, 3.4.14	70MH-EB024-GP03020, 2.7.4	70MH-MAL10-0000000, 2.7.10	70MH-MAL10-0010000, 2.7.10
7000-99109-0000000, 4.10.3, 4.12.10, 4.13.35	7000-99911-0000000, 3.4.14	70MH-ES006-DP03020, 2.7.3	70MH-MAM10-0000000, 2.7.10	70MH-MAP10-0020000, 2.7.10
7000-99201-0000000, 3.12.45	7000-99921-0000000, 3.4.14	70MH-ES010-EP03020, 2.7.4	70MH-MAP10-0030000, 2.7.10	70MH-MAQ2A-0010707, 2.7.6
7000-99205-0000000, 3.12.45	7000-99931-0000000, 3.4.14	70MH-ES016-FP03020, 2.7.4	70MH-MAR2A-0010707, 2.7.6	70MH-RD02B-0000000, 2.7.5
7000-99211-0000000, 3.12.45	7000-99951-0000000, 3.4.14	70MH-ES024-GP03020, 2.7.4	70MH-RD02S-0000000, 2.7.5	70MH-RE03B-0000000, 2.7.5
	7000-C0201-5880000, 3.6.36	70MH-GADNL-B000000, 2.7.2	70MH-RE03S-0000000, 2.7.5	70MH-RF04B-0000000, 2.7.5
		70MH-GAENQ-B000000, 2.7.2		
		70MH-GAFNQ-B000000, 2.7.2		
		70MH-GAGNQ-B000000, 2.7.2		
		70MH-GKENQ-B01C000, 2.7.3		
		70MH-GKFHQ-B01D000, 2.7.3		
		70MH-GKGHQ-B01D000, 2.7.3		
		70MH-GSDNL-B01B000, 2.7.2		
		70MH-GSDNL-B02B000, 2.7.2		
		70MH-GSEHQ-B02C000, 2.7.2		
		70MH-GSEHQ-B01C000, 2.7.2		

Art.-No., page	Art.-No., page	Art.-No., page	Art.-No., page	Art.-No., page
8000-84401-0000000, 4.13.9	9000-41000-0000000, 1.4.14	Form without cable type and length	7000-12421, 3.2.15	7000-19301, 3.2.19
8000-84402-0000000, 4.13.10	9000-41000-0000001, 1.4.14		7000-12441, 3.2.16	7000-19321, 3.2.22
8000-84440-0000000, 4.13.17	9000-41000-0000002, 1.4.14		7000-13061, 3.2.17	7000-19341, 3.2.25
8000-84450-0000000, 4.13.17	9000-41000-0000006, 1.4.14		7000-13081, 3.2.17	7000-19361, 3.2.28
8000-84451-0000000, 4.13.17	9000-41000-0000212, 1.4.1		7000-13101, 3.2.17	7000-21001, 3.6.15
8000-84452-0000000, 4.13.18	9000-41000-0002206, 1.4.1		7000-13105, 3.6.4	7000-21021, 3.6.15
8000-84470-0000000, 4.13.27	9000-41011-0200000, 1.4.2		7000-13121, 3.2.20	7000-23051, 3.9.1
8000-84500-0000000, 4.13.11	9000-41011-0400000, 1.4.2		7000-13125, 3.6.4	7000-23151, 3.9.1
8000-84501-0000000, 4.13.12	9000-41011-0600000, 1.4.2		7000-13141, 3.2.20	7000-23251, 3.9.2
8000-84502-0000000, 4.13.13	9000-41011-0800000, 1.4.2		7000-13161, 3.2.20	7000-23351, 3.9.3
8000-84520-0000000, 4.13.29	9000-41011-1000000, 1.4.2		7000-13181, 3.2.23	7000-23711, 3.9.4
8000-84530-0000000, 4.13.28	9000-41011-1600000, 1.4.2		7000-13201, 3.2.23	7000-23751, 3.9.4
8000-84540-0000000, 4.13.19	9000-41012-0200000, 1.4.2		7000-13221, 3.2.23	7000-40001, 3.2.29
8000-84550-0000000, 4.13.19	9000-41012-0400000, 1.4.2		7000-13225, 3.6.5	7000-40021, 3.2.29
8000-84551-0000000, 4.13.20	9000-41012-0600000, 1.4.2		7000-13241, 3.2.26	7000-40041, 3.2.29
8000-84552-0000000, 4.13.20	9000-41014-0200000, 1.4.2		7000-13251, 3.6.5	7000-40101, 3.2.32
8000-84560-0000000, 4.13.27	9000-41014-0400000, 1.4.2		7000-13261, 3.2.26	7000-40121, 3.2.32
8000-84949-0000000, 4.11.10, 4.11.15	9000-41014-0600000, 1.4.2		7000-13281, 3.2.26	7000-40141, 3.2.32
8000-86000-0000000, 4.11.5	9000-41034-0000001, 1.4.14		7000-13501, 3.4.2	7000-40321, 3.2.33
8000-86001-0000000, 4.11.6	9000-41034-0000002, 1.4.14		7000-13521, 3.4.2	7000-40341, 3.2.33
8000-86060-0000000, 4.11.13	9000-41034-0000003, 1.4.14		7000-13541, 3.4.3	7000-40361, 3.2.33
8000-86070-0000000, 4.11.12	9000-41034-0100400, 1.4.6		7000-13561, 3.4.3	7000-40381, 3.2.34
8000-86100-0000000, 4.11.7	9000-41034-0100600, 1.4.7		7000-14051, 3.6.1	7000-40481, 3.2.38
8000-88000-0000000, 4.11.5	9000-41034-0101000, 1.4.9		7000-14061, 3.6.2	7000-40501, 3.2.38
8000-88001-0000000, 4.11.6	9000-41034-0401000, 1.4.8	7000-14071, 3.6.2	7000-40521, 3.2.38	
8000-88060-0000000, 4.11.13	9000-41034-0401005, 1.4.9	7000-14081, 3.6.1	7000-40531, 3.6.6	
8000-88100-0000000, 4.11.7	9000-41042-0100400, 1.4.6	7000-14541, 3.6.12	7000-40551, 3.6.6	
8000-88400-0000000, 4.13.8	9000-41042-0100600, 1.4.7	7000-14561, 3.6.12	7000-40701, 3.2.35	
8000-88401-0000000, 4.13.9	9000-41042-0401000, 1.4.8	7000-15001, 3.6.28	7000-40721, 3.2.35	
8000-88402-0000000, 4.13.10	9000-41064-0200000, 1.4.11	7000-15021, 3.6.28	7000-40741, 3.2.36	
8000-88430-0000000, 4.13.28	9000-41064-0400000, 1.4.11	7000-15501, 3.6.13	7000-40761, 3.2.36	
8000-88440-0000000, 4.13.21	9000-41064-0600000, 1.4.11	7000-15521, 3.6.14	7000-40781, 3.2.37	
8000-88450-0000000, 4.13.21	9000-41068-0200000, 1.4.10	7000-15551, 3.6.13	7000-40801, 3.2.37	
8000-88451-0000000, 4.13.22	9000-41068-0200600, 1.4.12	7000-15571, 3.6.14	7000-40881, 3.12.19	
8000-88452-0000000, 4.13.22	9000-41068-0400000, 1.4.10	7000-17001, 3.2.2	7000-40921, 3.12.20	
8000-88460-0000000, 4.13.27	9000-41068-0600000, 1.4.10	7000-17021, 3.2.5	7000-40931, 3.12.20	
8000-88500-0000000, 4.13.11	9000-41078-0000002, 1.4.14	7000-17041, 3.2.8	7000-40961, 3.12.21	
8000-88501-0000000, 4.13.12	9000-41078-0000004, 1.4.14	7000-17061, 3.2.11	7000-41001, 3.12.21	
8000-88502-0000000, 4.13.13	9000-41078-0000006, 1.4.14	7000-17081, 3.2.18	7000-41041, 3.12.22	
8000-88520-0000000, 4.13.29	9000-41078-0000010, 1.4.14	7000-17101, 3.2.21	7000-41081, 3.12.22	
8000-88540-0000000, 4.13.23	9000-41078-0600001, 1.4.13	7000-17121, 3.2.24	7000-41501, 3.12.17	
8000-88549-0000000, 4.13.16	9000-41078-0600002, 1.4.13	7000-17141, 3.2.27	7000-41521, 3.12.17	
8000-88550-0000000, 4.13.23	9000-41084-0100400, 1.4.4	7000-17161, 3.4.2	7000-41541, 3.12.17	
8000-88551-0000000, 4.13.24	9000-41084-0100600, 1.4.4	7000-17181, 3.4.3	7000-41561, 3.12.18	
8000-88552-0000000, 4.13.24	9000-41084-0401000, 1.4.5	7000-18001, 3.12.1	7000-41581, 3.12.18	
8000-88559-0000000, 4.13.16	9000-41091-0101000, 1.4.3	7000-18021, 3.12.1	7000-41601, 3.12.18	
8000-88580-0000000, 4.13.25	9000-41091-1102000, 1.4.3	7000-18041, 3.12.1	7000-44001, 3.6.3	
8000-88590-0000000, 4.13.26	9000-41092-0101000, 1.4.3	7000-18061, 3.12.2	7000-44021, 3.6.3	
8000-88680-0000000, 4.13.25	9000-41094-0101000, 1.4.3	7000-18081, 3.12.2	7000-44511, 3.6.16	
8000-88690-0000000, 4.13.26	9000-41190-0000000, 1.4.1	7000-18121, 3.12.3	7000-44561, 3.6.16	
8000-98700-0000000, 4.13.32		7000-18141, 3.12.3	7000-44711, 3.6.17	
8000-98790-0000000, 4.13.34		7000-19001, 3.2.3	7000-44731, 3.6.17	
9000-11112-1962020, 1.2.8		7000-19021, 3.2.6	7000-46041, 3.6.29	
9000-11112-2062020, 1.2.8		7000-19041, 3.2.9	7000-46061, 3.6.29	
		7000-12401, 3.2.14	7000-47001, 3.6.18	

INDEX

Art.-No., page	Art.-No., page	Art.-No., page	Art.-No., page	Art.-No., page
7000-47021, 3.6.18	7000-88041, 3.1.8	7000-P8281, 3.4.10	7072-70061, 3.8.1	7700-48551, 3.11.29
7000-47051, 3.6.18	7000-89401, 3.6.11	7000-P8291, 3.4.11	7072-70301, 3.8.2	7700-48561, 3.11.27
7000-48001, 3.2.30	7000-89431, 3.6.11	7000-P8301, 3.10.19	7072-70321, 3.8.2	7700-48571, 3.11.28
7000-48041, 3.2.39	7000-89501, 3.1.11	7000-P8321, 3.10.19	7072-70361, 3.8.2	7700-48851, 3.11.30
7000-50021, 3.10.30	7000-89511, 3.1.11	7000-P8331, 3.10.22	7072-72011, 3.8.3	7700-51001, 3.11.32
7000-50051, 3.10.30	7000-89521, 3.1.16	7000-P8332, 3.10.22	7072-72081, 3.8.3	7700-51011, 3.11.32
7000-51001, 3.6.19	7000-89531, 3.1.16	7000-P8341, 3.10.28	7072-72161, 3.8.4	7700-51021, 3.11.33
7000-51021, 3.6.19	7000-89701, 3.6.8	7000-P8381, 3.4.10	7072-72191, 3.8.5	7700-51101, 3.11.34
7000-51101, 3.6.20	7000-89721, 3.6.9	7000-P8391, 3.4.11	7072-72221, 3.8.4	7700-51201, 3.11.34
7000-51551, 3.6.20	7000-89771, 3.6.8	7014-12221, 3.7.10	7072-72301, 3.8.6	7700-51551, 3.11.35
7000-53001, 3.2.31	7000-89781, 3.6.9	7014-12341, 3.7.10	7072-72381, 3.8.6	7700-74101, 3.11.12
7000-53301, 3.2.40	7000-94001, 3.12.10	7014-12421, 3.7.11	7072-72461, 3.8.7	7700-74118, 3.11.16
7000-58001, 3.12.12	7000-94021, 3.12.10	7014-13221, 3.7.12	7072-72521, 3.8.7	7700-74301, 3.11.25
7000-58021, 3.12.12	7000-94041, 3.12.11	7014-13281, 3.7.12	7072-73001, 3.8.8	7700-74315, 3.11.35
7000-58041, 3.12.12	7000-94061, 3.12.11	7014-40021, 3.7.13	7072-73081, 3.8.8	7700-74718, 3.11.31
7000-58101, 3.12.14	7000-99621, 3.6.27	7014-40121, 3.7.13	7072-73161, 3.8.9	7700-A3001, 3.11.36
7000-58121, 3.12.14	7000-99641, 3.6.27	7014-40341, 3.7.14	7072-73221, 3.8.9	7700-A3011, 3.11.39
7000-58141, 3.12.14	7000-P3201, 3.10.1	7024-12001, 3.7.1	7072-73301, 3.8.10	7700-A3021, 3.11.42
7000-58201, 3.12.13	7000-P3221, 3.10.2	7024-12021, 3.7.2	7072-73381, 3.8.10	7700-A3031, 3.11.45
7000-58221, 3.12.13	7000-P3241, 3.10.5	7024-12041, 3.7.3	7072-73461, 3.8.11	7700-A3A01, 3.11.48
7000-58241, 3.12.13	7000-P4201, 3.10.1	7024-12081, 3.7.1	7072-73521, 3.8.11	7700-A3A31, 3.11.49
7000-58401, 3.12.15	7000-P4221, 3.10.2	7024-12101, 3.7.2	7700-12021, 3.11.1	7700-A4001, 3.11.37
7000-58411, 3.12.15	7000-P4241, 3.10.5	7024-12121, 3.7.3	7700-12041, 3.11.2	7700-A4011, 3.11.40
7000-58421, 3.12.15	7000-P4281, 3.4.5	7024-12181, 3.7.4	7700-12101, 3.11.1	7700-A4021, 3.11.43
7000-58431, 3.12.16	7000-P4291, 3.4.5	7024-12221, 3.7.5	7700-12121, 3.11.2	7700-A4031, 3.11.46
7000-58441, 3.12.16	7000-P6201, 3.10.3	7024-12241, 3.7.6	7700-12221, 3.11.3	7700-A4A01, 3.11.50
7000-58451, 3.12.16	7000-P6221, 3.10.4	7024-12321, 3.7.4	7700-12241, 3.11.4	7700-A4A31, 3.11.51
7000-74101, 3.6.21	7000-P6241, 3.10.6	7024-12341, 3.7.5	7700-12341, 3.11.3	7700-A5001, 3.11.38
7000-74121, 3.6.21	7000-P6281, 3.4.6	7024-12361, 3.7.6	7700-12361, 3.11.4	7700-A5011, 3.11.41
7000-74141, 3.6.21	7000-P6291, 3.4.6	7024-12441, 3.7.7	7700-14511, 3.11.11	7700-A5021, 3.11.44
7000-74161, 3.6.22	7000-P7201, 3.10.3	7024-40001, 3.7.8	7700-14541, 3.11.9	7700-A5031, 3.11.47
7000-74181, 3.6.22	7000-P7221, 3.10.4	7024-40021, 3.7.8	7700-14561, 3.11.10	7700-A5A01, 3.11.52
7000-74301, 3.6.23	7000-P7241, 3.10.6	7024-40041, 3.7.9	7700-17511, 3.11.15	7700-A5A31, 3.11.53
7000-74311, 3.6.24	7000-P7281, 3.4.7	7024-40281, 3.7.9	7700-17541, 3.11.13	8000-54510, 4.12.1
7000-74521, 3.6.23	7000-P7291, 3.4.7	7044-12021, 3.7.15	7700-17561, 3.11.13	8000-54512, 4.12.2
7000-74601, 3.6.26	7000-P8001, 3.10.20	7044-12101, 3.7.15	7700-17581, 3.11.14	8000-54513, 4.12.5
7000-74641, 3.6.26	7000-P8021, 3.10.21	7044-12221, 3.7.16	7700-40021, 3.11.5	8000-54515, 4.12.4
7000-74701, 3.6.25	7000-P8031, 3.10.23	7044-12241, 3.7.16	7700-40041, 3.11.7	8000-54712, 4.12.8
7000-74711, 3.6.25	7000-P8032, 3.10.24	7044-12292, 3.7.18	7700-40121, 3.11.5	8000-58510, 4.12.1
7000-78021, 3.10.29	7000-P8041, 3.10.27	7044-12341, 3.7.17	7700-40141, 3.11.7	8000-58511, 4.12.3
7000-78051, 3.10.29	7000-P8081, 3.4.8	7044-40021, 3.7.19	7700-40201, 3.11.6	8000-58512, 4.12.3
7000-78341, 3.4.4	7000-P8091, 3.4.9	7044-40121, 3.7.19	7700-40221, 3.11.8	8000-58513, 4.12.5
7000-78381, 3.4.4	7000-P8101, 3.10.10	7044-40201, 3.7.20	7700-40261, 3.11.6	8000-58515, 4.12.4
7000-80001, 3.12.8	7000-P8121, 3.10.11	7044-40261, 3.7.20	7700-40281, 3.11.8	8000-58610, 4.12.2
7000-80021, 3.12.8	7000-P8131, 3.10.14	7044-40312, 3.7.21	7700-44511, 3.11.17	8000-80010, 4.11.1
7000-80041, 3.12.9	7000-P8132, 3.10.15	7050-12221, 3.5.1	7700-44541, 3.11.18	8000-80011, 4.11.2
7000-80061, 3.12.9	7000-P8141, 3.10.26	7050-12341, 3.5.1	7700-44561, 3.11.19	8000-80040, 4.11.11
7000-87001, 3.1.9	7000-P8181, 3.4.8	7050-12421, 3.5.2	7700-44571, 3.11.20	8000-80049, 4.11.8
7000-87011, 3.1.9	7000-P8191, 3.4.9	7050-40021, 3.5.3	7700-44711, 3.11.22	8000-80110, 4.11.3
7000-87061, 3.1.14	7000-P8201, 3.10.12	7050-40121, 3.5.3	7700-44761, 3.11.23	8000-80111, 4.11.4
7000-87251, 3.1.14	7000-P8211, 3.10.16	7050-40341, 3.5.4	7700-44811, 3.11.21	8000-84010, 4.11.1
7000-88001, 3.1.6	7000-P8221, 3.10.13	7060-40005, 3.6.30	7700-44851, 3.11.24	8000-84011, 4.11.2
7000-88011, 3.1.6	7000-P8231, 3.10.17	7060-40021, 3.6.30	7700-48511, 3.11.26	8000-84040, 4.11.11
7000-88021, 3.1.7	7000-P8232, 3.10.18	7072-70001, 3.8.1	7700-48521, 3.11.29	8000-84049, 4.11.8
7000-88031, 3.1.7	7000-P8241, 3.10.25	7072-70021, 3.8.1	7700-48541, 3.11.26	8000-84110, 4.11.3

Art.-No., page

8000-84111, 4.11.4				
8000-84149, 4.11.9				
8000-84410, 4.13.1				
8000-84411, 4.13.2				
8000-84412, 4.13.3				
8000-84459, 4.13.14				
8000-84510, 4.13.4				
8000-84511, 4.13.6				
8000-84512, 4.13.7				
8000-84559, 4.13.14				
8000-84659, 4.13.14				
8000-84712, 4.13.30				
8000-86010, 4.11.1				
8000-86011, 4.11.2				
8000-86040, 4.11.11				
8000-86049, 4.11.8				
8000-86110, 4.11.3				
8000-86111, 4.11.4				
8000-86149, 4.11.9				
8000-88010, 4.11.1				
8000-88011, 4.11.2				
8000-88040, 4.11.11				
8000-88049, 4.11.8				
8000-88110, 4.11.3				
8000-88111, 4.11.4				
8000-88149, 4.11.9				
8000-88410, 4.13.1				
8000-88411, 4.13.2				
8000-88412, 4.13.3				
8000-88459, 4.13.15				
8000-88510, 4.13.4				
8000-88511, 4.13.6				
8000-88512, 4.13.7				
8000-88559, 4.13.15				
8000-88659, 4.13.15				
8000-98710, 4.13.31				
8000-98749, 4.13.33				
8099-84510, 4.13.5				
8099-88510, 4.13.5				

MURR
ELEKTRONIK

stay connected



➤ www.murrelektronik.com



9800012